



Chipsmall Limited consists of a professional team with an average of over 10 year of expertise in the distribution of electronic components. Based in Hongkong, we have already established firm and mutual-benefit business relationships with customers from,Europe,America and south Asia,supplying obsolete and hard-to-find components to meet their specific needs.

With the principle of “Quality Parts,Customers Priority,Honest Operation,and Considerate Service”,our business mainly focus on the distribution of electronic components. Line cards we deal with include Microchip,ALPS,ROHM,Xilinx,Pulse,ON,Everlight and Freescale. Main products comprise IC,Modules,Potentiometer,IC Socket,Relay,Connector.Our parts cover such applications as commercial,industrial, and automotives areas.

We are looking forward to setting up business relationship with you and hope to provide you with the best service and solution. Let us make a better world for our industry!



Contact us

Tel: +86-755-8981 8866 Fax: +86-755-8427 6832

Email & Skype: info@chipsmall.com Web: www.chipsmall.com

Address: A1208, Overseas Decoration Building, #122 Zhenhua RD., Futian, Shenzhen, China



Operational Amplifiers

Ground Sense Low Voltage Operation CMOS Operational Amplifiers

BU7461G BU7461SG BU7462xxx BU7462Sxxx BU7464F BU7464SF

General Description

BU7461G/BU7462xxx/BU7464F are input ground sense, output full swing CMOS operational amplifiers. BU7461SG/BU7462Sxxx/BU7464SF have an expanded operating temperature range. They have the features of low operating supply voltage, low supply current and low input bias current. These are suitable for portable equipment and sensor amplifiers.

Features

- Low Supply Current
- Low Operating Supply Voltage
- Wide Temperature Range
- Low Input Bias Current

Applications

- Sensor Amplifier
- Portable Equipment
- Consumer Equipment

Key Specifications

- Operating Supply Voltage: +1.7V to +5.5V
- Supply Current: 150µA/ch(Typ)
- Temperature Range:
 - BU7461G/BU7462xxx/BU7464F -40°C to +85°C
 - BU7461SG/BU7462Sxxx/BU7464SF -40°C to +105°C
- Input Offset Current: 1pA (Typ)
- Input Bias Current: 1pA (Typ)

Packages

	W(Typ) x D(Typ) x H(Max)
SSOP5	2.90mm x 2.80mm x 1.25mm
SOP8	5.00mm x 6.20mm x 1.71mm
MSOP8	2.90mm x 4.00mm x 0.90mm
VSON008X2030	2.00mm x 3.00mm x 0.60mm
SOP14	8.70mm x 6.20mm x 1.71mm

Simplified Schematic

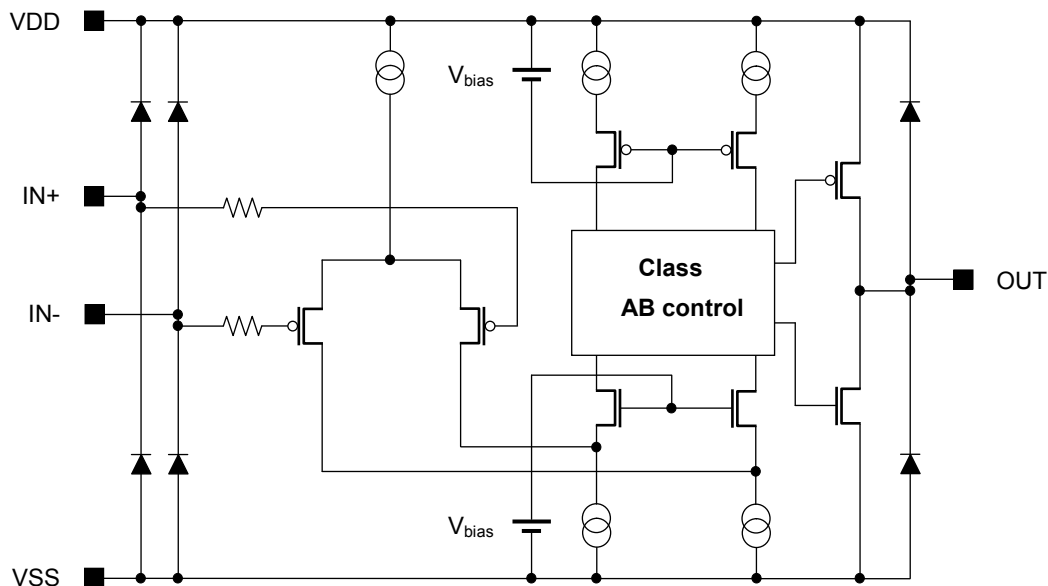
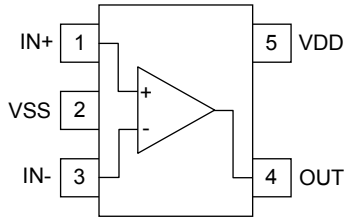

Figure 1. Simplified Schematic (1 channel only)

○Product structure : Silicon monolithic integrated circuit ○This product has no designed protection against radioactive rays

Pin Configuration

BU7461G, BU7461SG : SSOP5



Pin No.	Pin Name
1	IN+
2	VSS
3	IN-
4	OUT
5	VDD

BU7462F, BU7462SF : SOP8
 BU7462FVM, BU7462SFVM : MSOP8
 BU7462NUX, BU7462SNUX : VSON008X2030

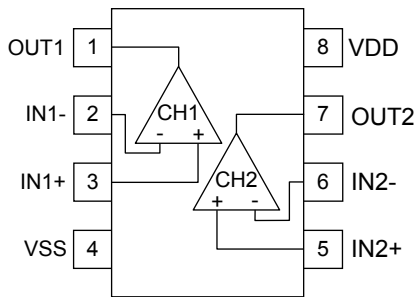

Pin No.	Pin Name
1	OUT1
2	IN1-
3	IN1+
4	VSS
5	IN2+
6	IN2-
7	OUT2
8	VDD

BU7464F, BU7464SF : SOP14

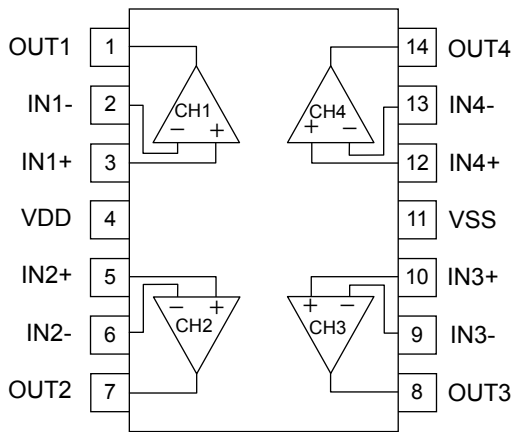

Pin No.	Pin Name
1	OUT1
2	IN-
3	IN+
4	VDD
5	IN2+
6	IN2-
7	OUT2
8	OUT3
9	IN3-
10	IN3+
11	VSS
12	IN4+
13	IN4-
14	OUT4

Package				
SSOP5	SOP8	MSOP8	VSON008X2030	SOP14
BU7461G BU7461SG	BU7462F BU7462SF	BU7462FVM BU7462SFVM	BU7462NUX BU7462SNUX	BU7464F BU7464SF

Ordering Information

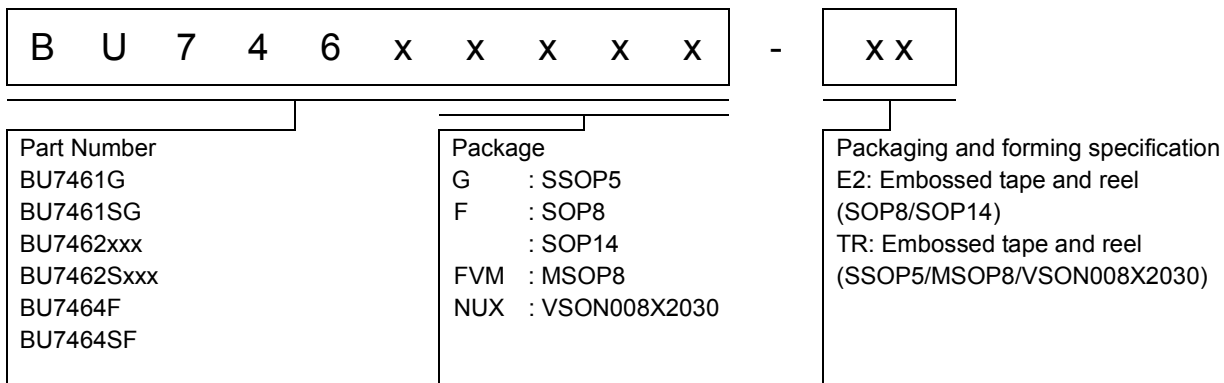

Line-up

T _{opr}	Channels	Package		Orderable Part Number
-40°C to +85°C	1ch	SSOP5	Reel of 3000	BU7461G-TR
	2ch	SOP8	Reel of 2500	BU7462F-E2
		MSOP8	Reel of 3000	BU7462FVM-TR
		VSON008X2030	Reel of 4000	BU7462NUX-TR
	4ch	SOP14	Reel of 2500	BU7464F-E2
-40°C to +105°C	1ch	SSOP5	Reel of 3000	BU7461SG-TR
	2ch	SOP8	Reel of 2500	BU7462SF-E2
		MSOP8	Reel of 3000	BU7462SFVM-TR
		VSON008X2030	Reel of 4000	BU7462SNUX-TR
	4ch	SOP14	Reel of 2500	BU7464SF-E2

Absolute Maximum Ratings($T_A=25^{\circ}\text{C}$)

Parameter	Symbol	Rating			Unit	
		BU7461G	BU7462xxx	BU7464F		
Supply Voltage	VDD-VSS	+7			V	
Power Dissipation	P_D	SSOP5	0.54 ^(Note1,6)	-	-	W
		SOP8	-	0.55 ^(Note2,6)	-	
		MSOP8	-	0.47 ^(Note3,6)	-	
		VSON008X2030	-	0.41 ^(Note4,6)	-	
		SOP14	-	-	0.45 ^(Note5,6)	
Differential Input Voltage ^(Note 7)	V_{ID}	VDD - VSS			V	
Input Common-mode Voltage Range	V_{ICM}	(VSS-0.3) to (VDD+0.3)			V	
Input Current ^(Note 8)	I_I	± 10			mA	
Operating Supply Voltage	V_{opr}	+1.7V to +5.5V			V	
Operating Temperature	T_{opr}	-40 to +85			$^{\circ}\text{C}$	
Storage Temperature	T_{stg}	-55 to +125			$^{\circ}\text{C}$	
Maximum Junction Temperature	T_{Jmax}	+125			$^{\circ}\text{C}$	

(Note 1) To use at temperature above $T_A=25^{\circ}\text{C}$ reduce 5.4mW/ $^{\circ}\text{C}$.

(Note 2) To use at temperature above $T_A=25^{\circ}\text{C}$ reduce 5.5mW/ $^{\circ}\text{C}$.

(Note 3) To use at temperature above $T_A=25^{\circ}\text{C}$ reduce 4.7mW/ $^{\circ}\text{C}$.

(Note 4) To use at temperature above $T_A=25^{\circ}\text{C}$ reduce 4.1mW/ $^{\circ}\text{C}$.

(Note 5) To use at temperature above $T_A=25^{\circ}\text{C}$ reduce 4.5mW/ $^{\circ}\text{C}$.

(Note 6) Mounted on a FR4 glass epoxy PCB 70mm×70mm×1.6mm (Copper foil area less than 3%).

(Note 7) The voltage difference between inverting input and non-inverting input is the differential input voltage. Then input terminal voltage is set to more than VSS.

(Note 8) An excessive input current will flow when input voltages of more than VDD+0.6V or less than VSS-0.6V are applied. The input current can be set to less than the rated current by adding a limiting resistor.

Caution: Operating the IC over the absolute maximum ratings may damage the IC. In addition, it is impossible to predict all destructive situations such as short-circuit modes, open circuit modes, etc. Therefore, it is important to consider circuit protection measures, like adding a fuse, in case the IC is operated in a special mode exceeding the absolute maximum ratings.

Parameter	Symbol	Rating			Unit	
		BU7461SG	BU7462Sxxx	BU7464SF		
Supply Voltage	VDD-VSS	+7			V	
Power Dissipation	P_D	SSOP5	0.54 ^(Note9,14)	-	-	W
		SOP8	-	0.55 ^(Note10,14)	-	
		MSOP8	-	0.47 ^(Note11,14)	-	
		VSON008X2030	-	0.41 ^(Note12,14)	-	
		SOP14	-	-	0.45 ^(Note13,14)	
Differential Input Voltage ^(Note 15)	V_{ID}	VDD - VSS			V	
Input Common-mode Voltage Range	V_{ICM}	(VSS-0.3) to (VDD+0.3)			V	
Input Current ^(Note 16)	I_I	± 10			mA	
Operating Supply Voltage	V_{opr}	+1.7V to +5.5V			V	
Operating Temperature	T_{opr}	-40 to +105			$^{\circ}\text{C}$	
Storage Temperature	T_{stg}	-55 to +125			$^{\circ}\text{C}$	
Maximum Junction Temperature	T_{Jmax}	+125			$^{\circ}\text{C}$	

(Note 9) To use at temperature above $T_A=25^{\circ}\text{C}$ reduce 5.4mW/ $^{\circ}\text{C}$.

(Note 10) To use at temperature above $T_A=25^{\circ}\text{C}$ reduce 5.5mW/ $^{\circ}\text{C}$.

(Note 11) To use at temperature above $T_A=25^{\circ}\text{C}$ reduce 4.7mW/ $^{\circ}\text{C}$.

(Note 12) To use at temperature above $T_A=25^{\circ}\text{C}$ reduce 4.1mW/ $^{\circ}\text{C}$.

(Note 13) To use at temperature above $T_A=25^{\circ}\text{C}$ reduce 4.5mW/ $^{\circ}\text{C}$.

(Note 14) Mounted on a FR4 glass epoxy PCB 70mm×70mm×1.6mm (Copper foil area less than 3%).

(Note 15) The voltage difference between inverting input and non-inverting input is the differential input voltage. Then input terminal voltage is set to more than VSS.

(Note 16) An excessive input current will flow when input voltages of more than VDD+0.6V or less than VSS-0.6V are applied. The input current can be set to less than the rated current by adding a limiting resistor.

Caution: Operating the IC over the absolute maximum ratings may damage the IC. In addition, it is impossible to predict all destructive situations such as short-circuit modes, open circuit modes, etc. Therefore, it is important to consider circuit protection measures, like adding a fuse, in case the IC is operated in a special mode exceeding the absolute maximum ratings.

Electrical Characteristics

 OBU7461G, BU7461SG (Unless otherwise specified VDD=+3V, VSS=0V, T_A=25°C)

Parameter	Symbol	Temperature Range	Limit			Unit	Conditions
			Min	Typ	Max		
Input Offset Voltage ^(Note 17)	V _{IO}	25°C	-	1	6	mV	-
Input Offset Current ^(Note 17)	I _{IO}	25°C	-	1	-	pA	-
Input Bias Current ^(Note 17)	I _B	25°C	-	1	-	pA	-
Supply Current ^(Note 18)	I _{DD}	25°C	-	150	350	μA	R _L =∞ A _V =0dB, I _N +0.9V
		Full range	-	-	450		
Maximum Output Voltage(High)	V _{OH}	25°C	VDD-0.1	-	-	V	R _L =10kΩ
Maximum Output Voltage(Low)	V _{OL}	25°C	-	-	VSS+0.1	V	R _L =10kΩ
Large Signal Voltage Gain	A _V	25°C	70	95	-	dB	R _L =10kΩ
Input Common-mode Voltage Range	V _{ICM}	25°C	0	-	1.8	V	VSS to VDD-1.2V
Common-mode Rejection Ratio	CMRR	25°C	45	60	-	dB	-
Power Supply Rejection Ratio	PSRR	25°C	60	80	-	dB	-
Output Source Current ^(Note 19)	I _{SOURCE}	25°C	4	8	-	mA	VDD-0.4V
Output Sink Current ^(Note 19)	I _{SINK}	25°C	6	12	-	mA	VSS+0.4V
Slew Rate	SR	25°C	-	1	-	V/μs	C _L =25pF
Gain Bandwidth	GBW	25°C	-	1	-	MHz	C _L =25pF, A _V =40dB
Phase Margin	θ	25°C	-	50	-	deg	C _L =25pF, A _V =40dB
Total Harmonic Distortion + Noise	THD+N	25°C	-	0.05	-	%	OUT=0.8V _{P-P} f=1kHz

(Note 17) Absolute value

 (Note 18) Full range: BU7461G: T_A=-40°C to +85°C, BU7461SG: T_A=-40°C to +105°C

(Note 19) Under the high temperature environment, consider the power dissipation of IC when selecting the output current.

When the terminal short circuits are continuously output, the output current is reduced to climb to the temperature inside IC.

Electrical Characteristics - continued

 OBU7462xxx, BU7462Sxxx (Unless otherwise specified VDD=+3V, VSS=0V, T_A=25°C)

Parameter	Symbol	Temperature Range	Limit			Unit	Conditions
			Min	Typ	Max		
Input Offset Voltage ^(Note 20)	V _{IO}	25°C	-	1	6	mV	-
Input Offset Current ^(Note 20)	I _{IO}	25°C	-	1	-	pA	-
Input Bias Current ^(Note 20)	I _B	25°C	-	1	-	pA	-
Supply Current ^(Note 21)	I _{DD}	25°C	-	300	700	μA	R _L =∞, All Op-Amps A _V =0dB, I _{N+} =0.9V
		Full range	-	-	900		
Maximum Output Voltage(High)	V _{OH}	25°C	VDD-0.1	-	-	V	R _L =10kΩ
Maximum Output Voltage(Low)	V _{OL}	25°C	-	-	VSS+0.1	V	R _L =10kΩ
Large Signal Voltage Gain	A _V	25°C	70	95	-	dB	R _L =10kΩ
Input Common-mode Voltage Range	V _{ICM}	25°C	0	-	1.8	V	VSS to VDD-1.2V
Common-mode Rejection Ratio	CMRR	25°C	45	60	-	dB	-
Power Supply Rejection Ratio	PSRR	25°C	60	80	-	dB	-
Output Source Current ^(Note 22)	I _{SOURCE}	25°C	4	8	-	mA	VDD-0.4V
Output Sink Current ^(Note 22)	I _{SINK}	25°C	6	12	-	mA	VSS+0.4V
Slew Rate	SR	25°C	-	1	-	V/μs	C _L =25pF
Gain Bandwidth	GBW	25°C	-	1	-	MHz	C _L =25pF, A _V =40dB
Phase Margin	θ	25°C	-	50	-	deg	C _L =25pF, A _V =40dB
Total Harmonic Distortion + Noise	THD+N	25°C	-	0.05	-	%	OUT=0.8V _{P-P} f=1kHz
Channel Separation	CS	25°C	-	100	-	dB	A _V =40dB, OUT=1Vrms

(Note 20) Absolute value

 (Note 21) Full range: BU7462xxx: T_A=-40°C to +85°C, BU7462Sxxx: T_A=-40°C to +105°C

(Note 22) Under the high temperature environment, consider the power dissipation of IC when selecting the output current.

When the terminal short circuits are continuously output, the output current is reduced to climb to the temperature inside IC.

Electrical Characteristics - continued

OBU7464F, BU7464SF (Unless otherwise specified VDD=+3V, VSS=0V, TA=25°C)

Parameter	Symbol	Temperature Range	Limit			Unit	Conditions
			Min	Typ	Max		
Input Offset Voltage ^(Note 23)	V _{IO}	25°C	-	1	6	mV	-
Input Offset Current ^(Note 23)	I _{IO}	25°C	-	1	-	pA	-
Input Bias Current ^(Note 23)	I _B	25°C	-	1	-	pA	-
Supply Current ^(Note 24)	I _{DD}	25°C	-	600	1400	μA	R _L =∞, All Op-Amps A _V =0dB, I _{N+} =0.9V
		Full range	-	-	1800		
Maximum Output Voltage(High)	V _{OH}	25°C	VDD-0.1	-	-	V	R _L =10kΩ
Maximum Output Voltage(Low)	V _{OL}	25°C	-	-	VSS+0.1	V	R _L =10kΩ
Large Signal Voltage Gain	A _V	25°C	70	95	-	dB	R _L =10kΩ
Input Common-mode Voltage Range	V _{ICM}	25°C	0	-	1.8	V	VSS to VDD-1.2V
Common-mode Rejection Ratio	CMRR	25°C	45	60	-	dB	-
Power Supply Rejection Ratio	PSRR	25°C	60	80	-	dB	-
Output Source Current ^(Note 25)	I _{SOURCE}	25°C	4	8	-	mA	VDD-0.4V
Output Sink Current ^(Note 25)	I _{SINK}	25°C	6	12	-	mA	VSS+0.4V
Slew Rate	SR	25°C	-	1	-	V/μs	C _L =25pF
Gain Bandwidth	GBW	25°C	-	1	-	MHz	C _L =25pF, A _V =40dB
Phase Margin	θ	25°C	-	50	-	deg	C _L =25pF, A _V =40dB
Total Harmonic Distortion + Noise	THD+N	25°C	-	0.05	-	%	OUT=0.8V _{P-P} f=1kHz
Channel Separation	CS	25°C	-	100	-	dB	A _V =40dB, OUT=1Vrms

(Note 23) Absolute value

 (Note 24) Full range: BU7464F: T_A=-40°C to +85°C, BU7464SF: T_A=-40°C to +105°C

(Note 25) Under the high temperature environment, consider the power dissipation of IC when selecting the output current.

When the terminal short circuits are continuously output, the output current is reduced to climb to the temperature inside IC.

Description of Electrical Characteristics

Described here are the terms of electric characteristics used in this technical note. Items and symbols used are also shown. Note that item name and symbol and their meaning may differ from those on another manufacturer's document or general document.

1. Absolute maximum ratings

Absolute maximum rating item indicates the condition which must not be exceeded. Application of voltage in excess of absolute maximum rating or use out of absolute maximum rated temperature environment may cause deterioration of characteristics.

- (1) Supply Voltage (VDD/VSS)
Indicates the maximum voltage that can be applied between the VDD terminal and VSS terminal without deterioration or destruction of characteristics of internal circuit.
- (2) Differential Input Voltage (V_{ID})
Indicates the maximum voltage that can be applied between non-inverting terminal and inverting terminal without deterioration and destruction of characteristics of IC.
- (3) Input Common-mode Voltage Range (V_{ICM})
Indicates the maximum voltage that can be applied to the non-inverting and inverting terminals without deterioration or destruction of electrical characteristics. Input common-mode voltage range of the maximum ratings does not assure normal operation of IC. For normal operation, use the IC within the input common-mode voltage range characteristics.
- (4) Power Dissipation (P_D)
Indicates the power that can be consumed by the IC when mounted on a specific board at the ambient temperature 25°C (normal temperature). As for package product, P_D is determined by the temperature that can be permitted by the IC in the package (maximum junction temperature) and the thermal resistance of the package.

2. Electrical characteristics

- (1) Input Offset Voltage (V_{IO})
Indicates the voltage difference between non-inverting terminal and inverting terminals. It can be translated into the input voltage difference required for setting the output voltage at 0V.
- (2) Input Offset Current (I_{IO})
Indicates the difference of input bias current between the non-inverting and inverting terminals.
- (3) Input Bias Current (I_B)
Indicates the current that flows into or out of the input terminal. It is defined by the average of input bias currents at the non-inverting and inverting terminals.
- (4) Supply Current (I_{DD})
Indicates the current that flows within the IC under specified no-load conditions.
- (5) Maximum Output Voltage(High) / Maximum Output Voltage(Low) (V_{OH}/V_{OL})
Indicates the voltage range of the output under specified load condition. It is typically divided into maximum output voltage High and low. Maximum output voltage high indicates the upper limit of output voltage. Maximum output voltage low indicates the lower limit.
- (6) Large Signal Voltage Gain (A_v)
Indicates the amplifying rate (gain) of output voltage against the voltage difference between non-inverting terminal and inverting terminal. It is normally the amplifying rate (gain) with reference to DC voltage.
 $A_v = (\text{Output voltage}) / (\text{Differential Input voltage})$
- (7) Input Common-mode Voltage Range (V_{ICM})
Indicates the input voltage range where IC operates normally.
- (8) Common-mode Rejection Ratio (CMRR)
Indicates the ratio of fluctuation of input offset voltage when the input common mode voltage is changed. It is normally the fluctuation of DC.
 $CMRR = (\text{Change of Input common-mode voltage}) / (\text{Input offset fluctuation})$
- (9) Power Supply Rejection Ratio (PSRR)
Indicates the ratio of fluctuation of input offset voltage when supply voltage is changed.
It is normally the fluctuation of DC.
 $PSRR = (\text{Change of power supply voltage}) / (\text{Input offset fluctuation})$
- (10) Output Source Current/ Output Sink Current (I_{SOURCE} / I_{SINK})
The maximum current that can be output from the IC under specific output conditions. The output source current indicates the current flowing out from the IC, and the output sink current indicates the current flowing into the IC.
- (11) Slew Rate (SR)
Indicates the ratio of the change in output voltage with time when a step input signal is applied.
- (12) Gain Bandwidth (GBW)
Indicates a frequency where the voltage gain of operational amplifier is 1.
- (13) Phase Margin (θ)
Indicates the margin of phase from 180 degree phase lag at unity gain frequency.
- (14) Total Harmonic Distortion + Noise (THD+N)
Indicates the fluctuation of input offset voltage or that of output voltage with reference to the change of output voltage of driven channel.
- (15) Channel Separation (CS)
Indicates the fluctuation in the output voltage of the driven channel with reference to the change of output voltage of the channel which is not driven.

Typical Performance Curves

OBU7461G, BU7461SG

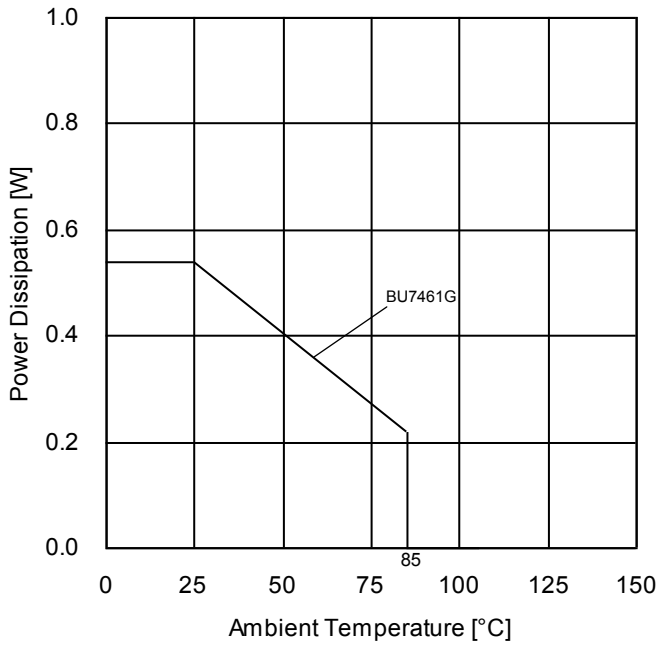

Figure 2.
Power Dissipation vs Ambient Temperature Derating Curve

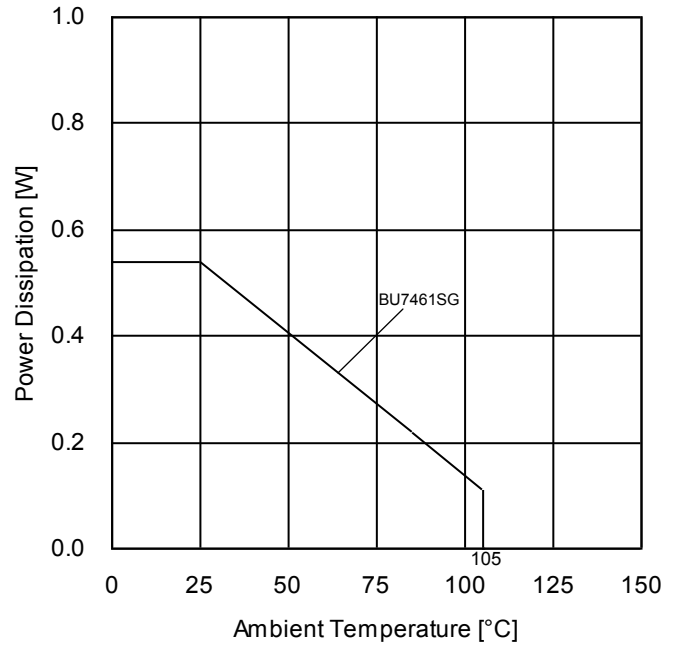

Figure 3.
Power Dissipation vs Ambient Temperature Derating Curve

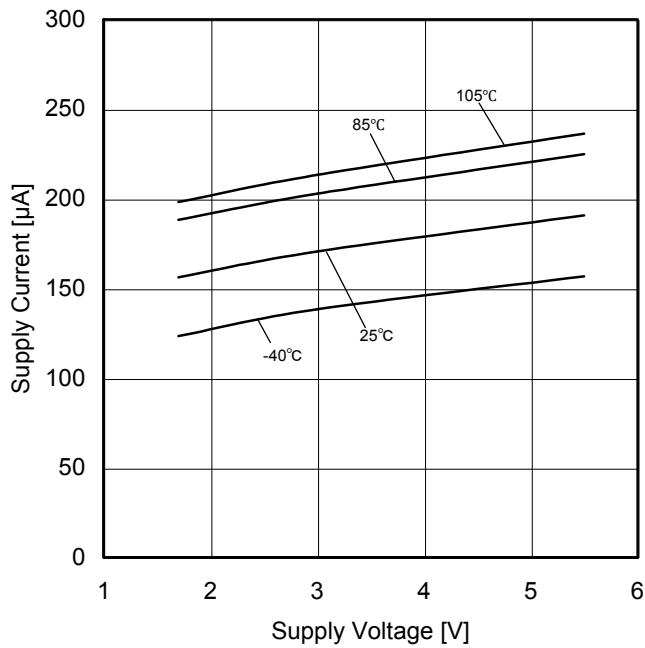

Figure 4.
Supply Current vs Supply Voltage

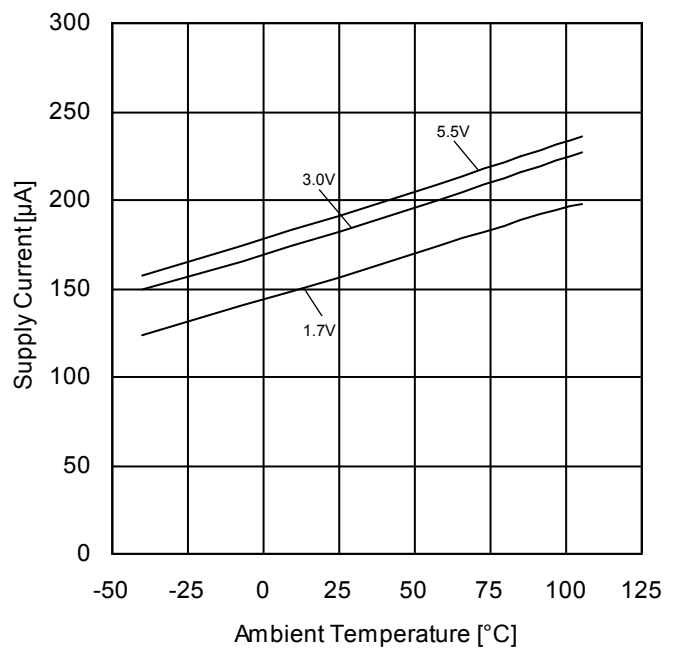

Figure 5.
Supply Current vs Ambient Temperature

(*)The above characteristics are measurements of typical sample, they are not guaranteed.
BU7461G: -40°C to +85°C BU7461SG: -40°C to +105°C

Typical Performance Curves – continued

OBU7461G, BU7461SG

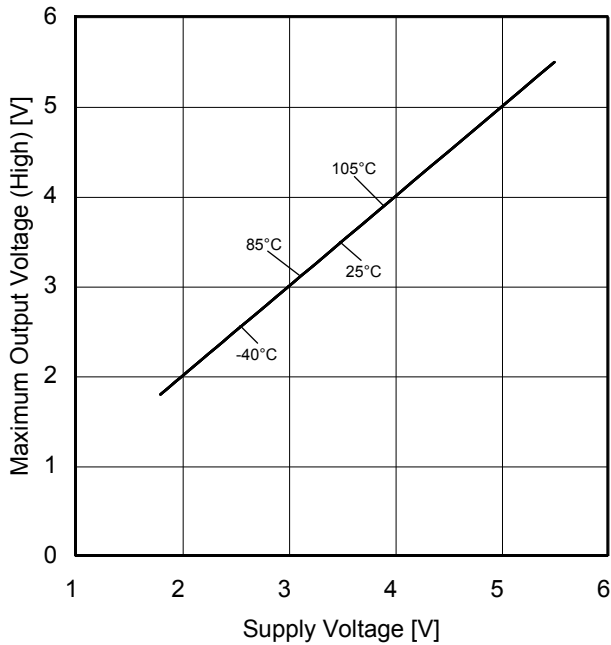

Figure 6.
Maximum Output Voltage (High) vs Supply Voltage
($R_L=10k\Omega$)

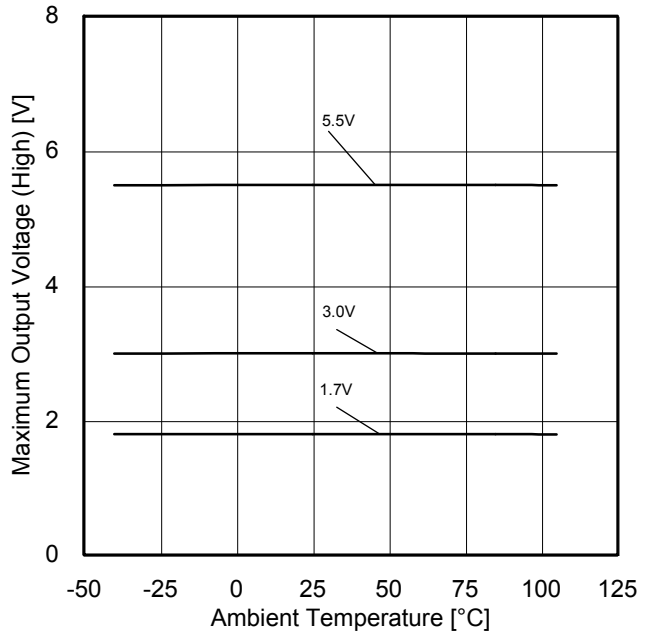

Figure 7.
Maximum Output Voltage (High) vs Ambient Temperature
($R_L=10k\Omega$)

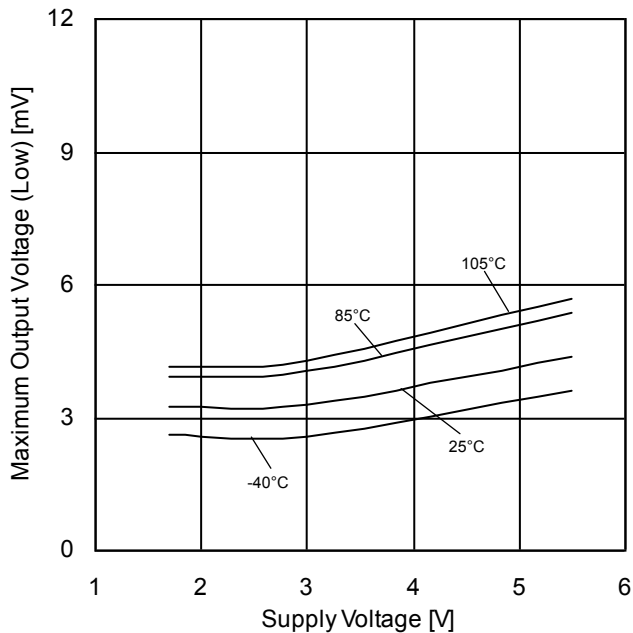

Figure 8.
Maximum Output Voltage (Low) vs Supply Voltage
($R_L=10k\Omega$)

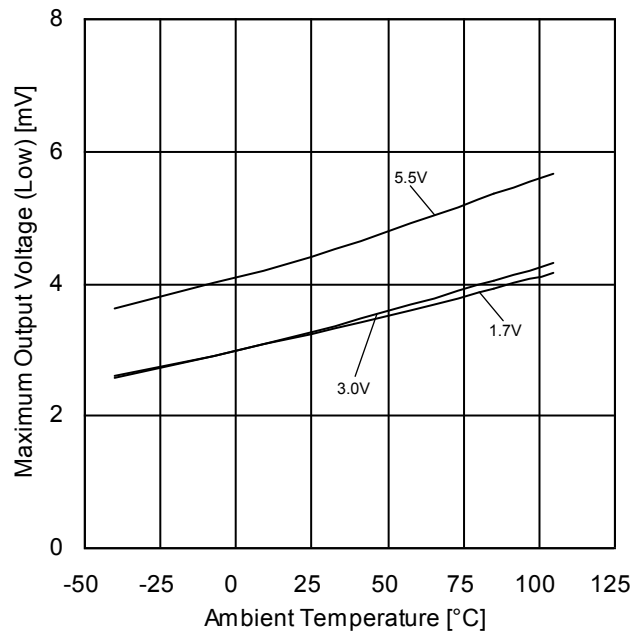

Figure 9.
Maximum Output Voltage (Low) vs Ambient Temperature
($R_L=10k\Omega$)

(*)The above characteristics are measurements of typical sample, they are not guaranteed.
BU7461G: -40°C to +85°C BU7461SG: -40°C to +105°C

Typical Performance Curves – continued

OBU7461G, BU7461SG

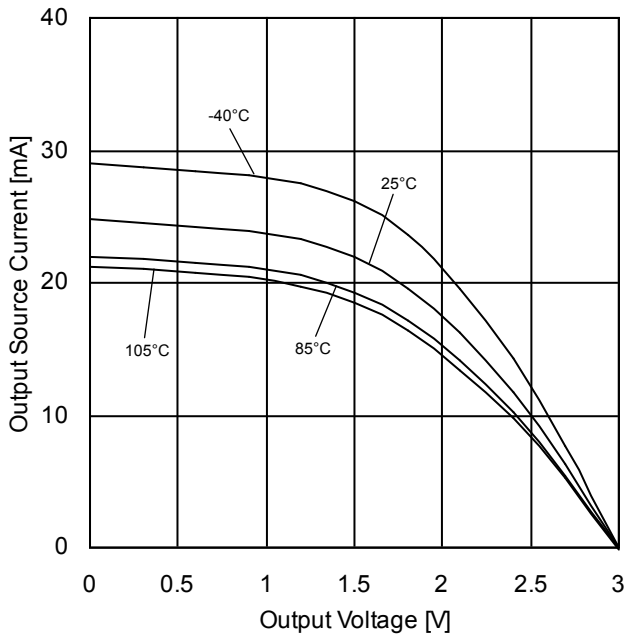

Figure 10.
Output Source Current vs Output Voltage
(VDD=3 V)

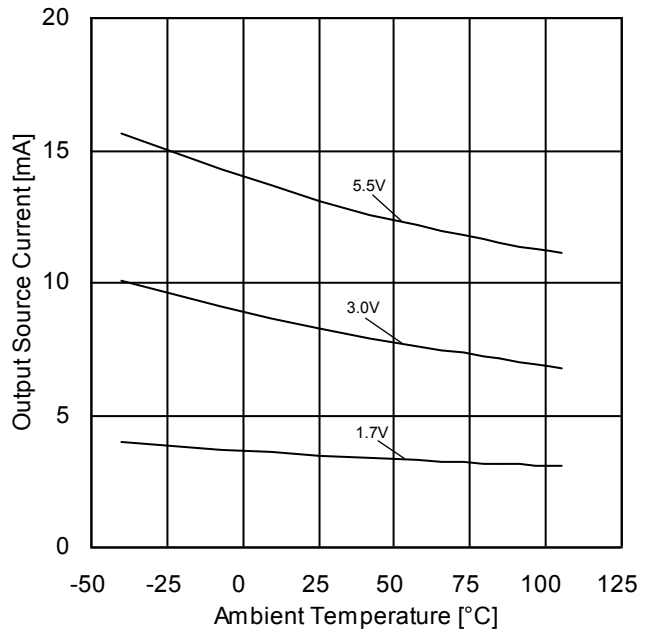

Figure 11.
Output Source Current vs Ambient Temperature
(OUT=VDD-0.4V)

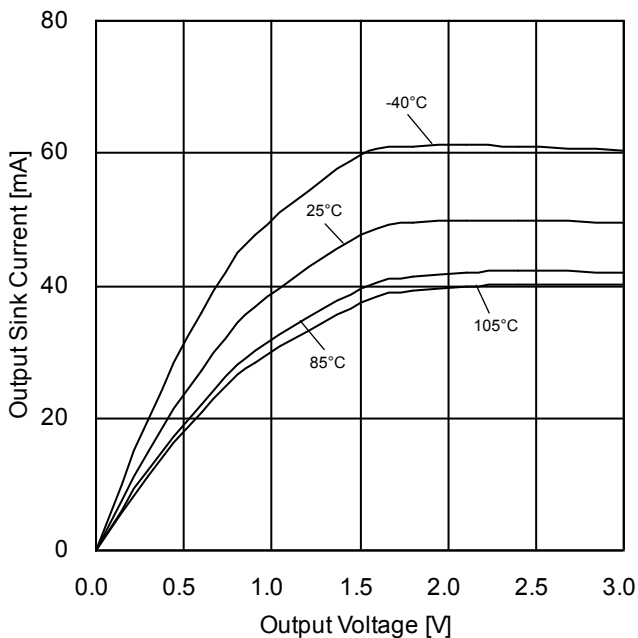

Figure 12.
Output Sink Current vs Output Voltage
(VDD=3V)

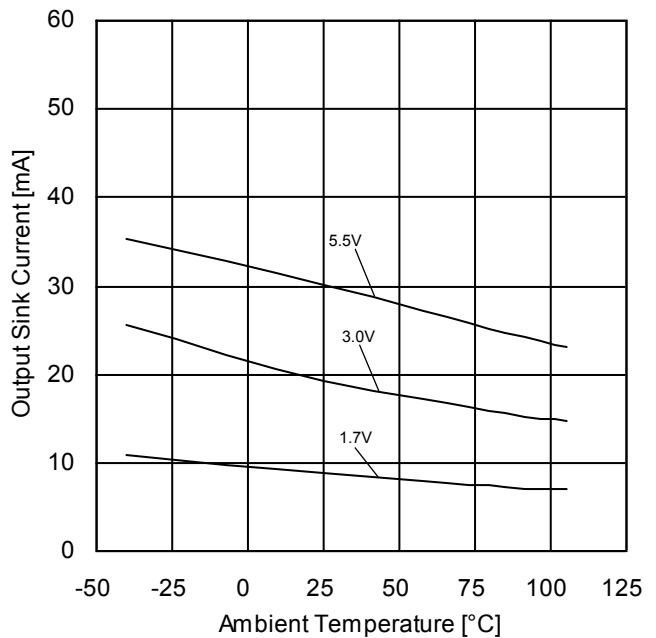

Figure 13.
Output Sink Current vs Ambient Temperature
(OUT=VSS+0.4V)

(*)The above characteristics are measurements of typical sample, they are not guaranteed.
BU7461G: -40°C to +85°C BU7461SG: -40°C to +105°C

Typical Performance Curves – continued

OBU7461G, BU7461SG

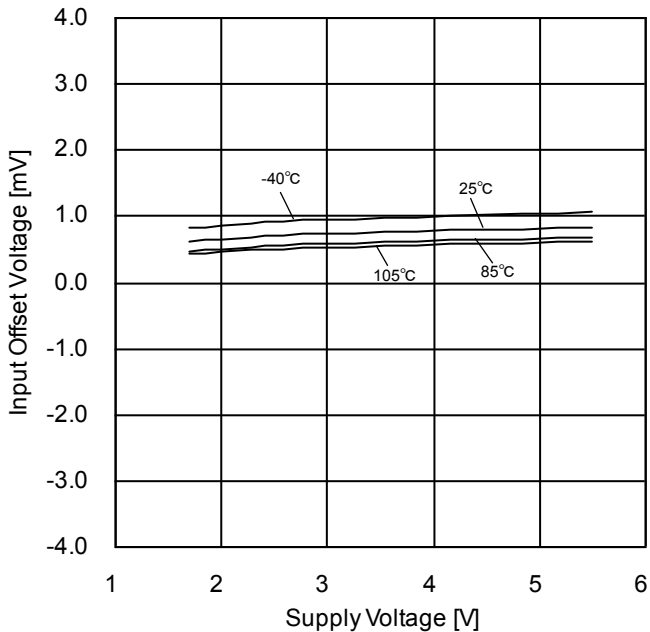

Figure 14.
Input Offset Voltage vs Supply Voltage
($V_{ICM}=V_{DD}-1.2V$, $E_k=-V_{DD}/2$)

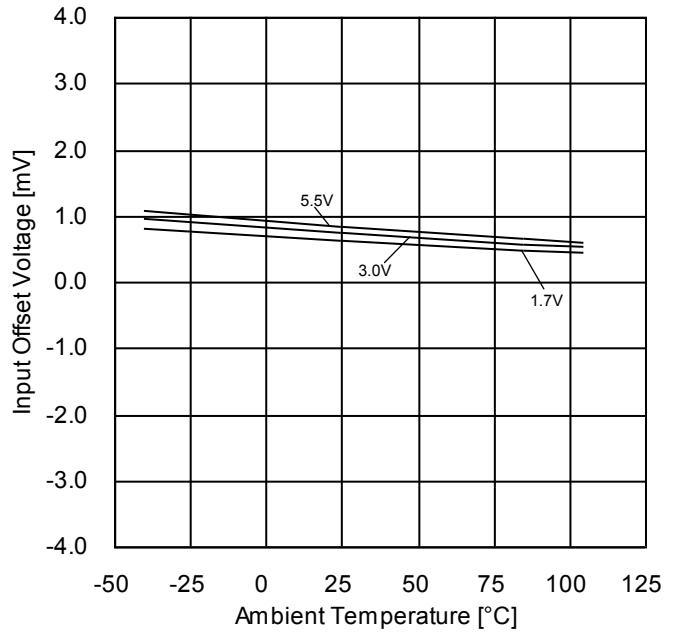

Figure 15.
Input Offset Voltage vs Ambient Temperature
($V_{ICM}=V_{DD}-1.2V$, $E_k=-V_{DD}/2$)

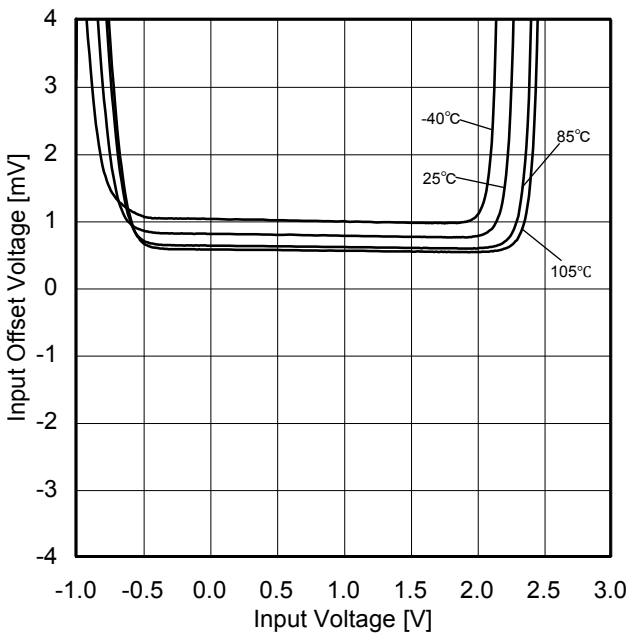

Figure 16.
Input Offset Voltage vs Input Voltage
($V_{DD}=3V$)

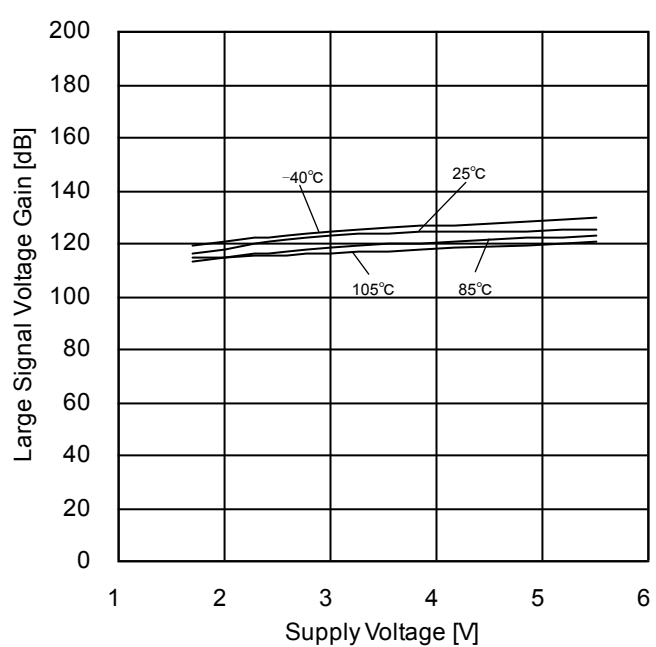

Figure 17.
Large Signal Voltage Gain vs Supply Voltage

(*)The above characteristics are measurements of typical sample, they are not guaranteed.
BU7461G: -40°C to +85°C BU7461SG: -40°C to +105°C

Typical Performance Curves – continued

OBU7461G, BU7461SG

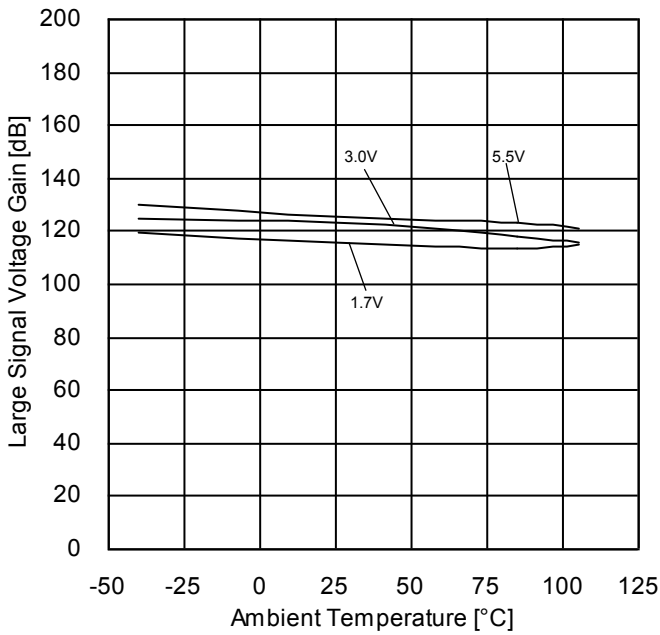

Figure 18.
Large Signal Voltage Gain vs Ambient Temperature

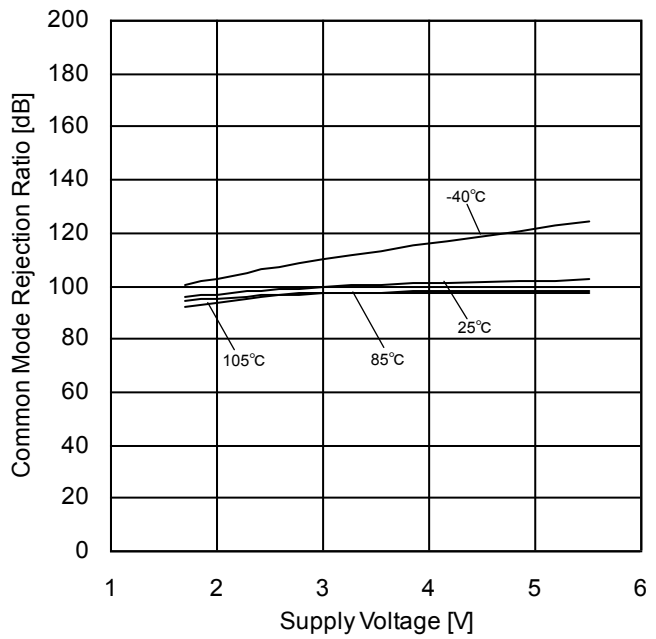

Figure 19.
Common Mode Rejection Ratio vs Supply Voltage

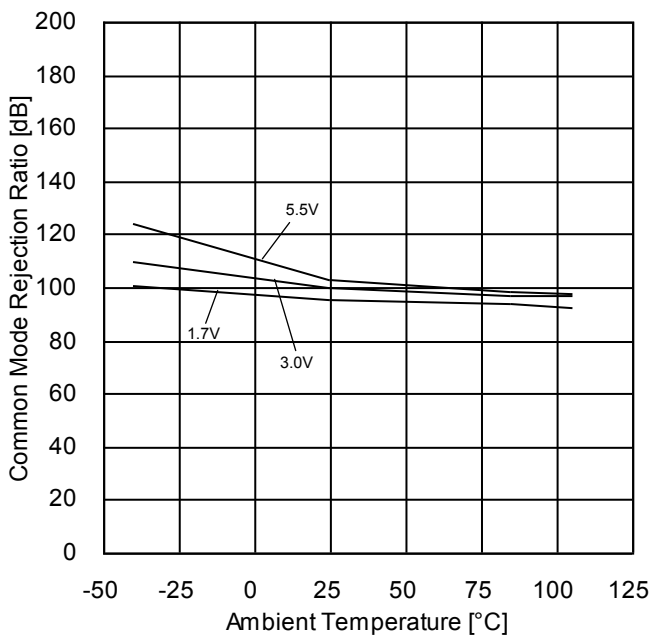

Figure 20.
Common Mode Rejection Ratio vs Ambient Temperature

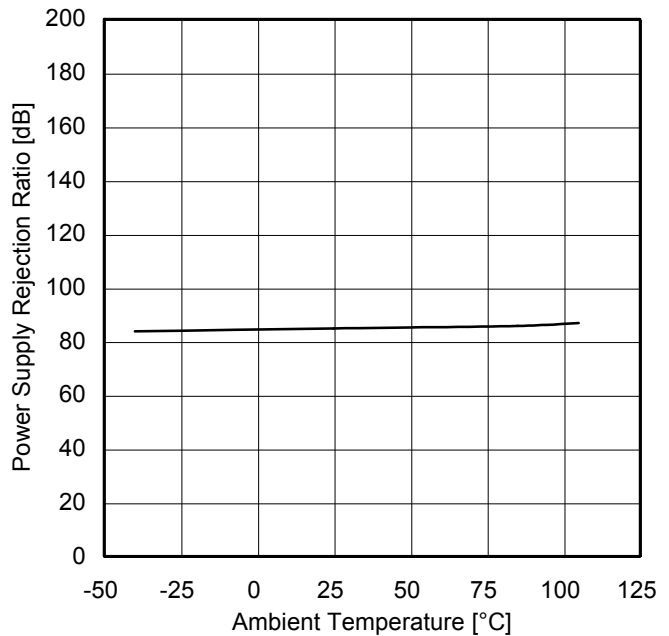

Figure 21.
Power Supply Rejection Ratio vs Ambient Temperature

(*)The above characteristics are measurements of typical sample, they are not guaranteed.
BU7461G: -40°C to +85°C BU7461SG: -40°C to +105°C

Typical Performance Curves – continued

OBU7461G, BU7461SG

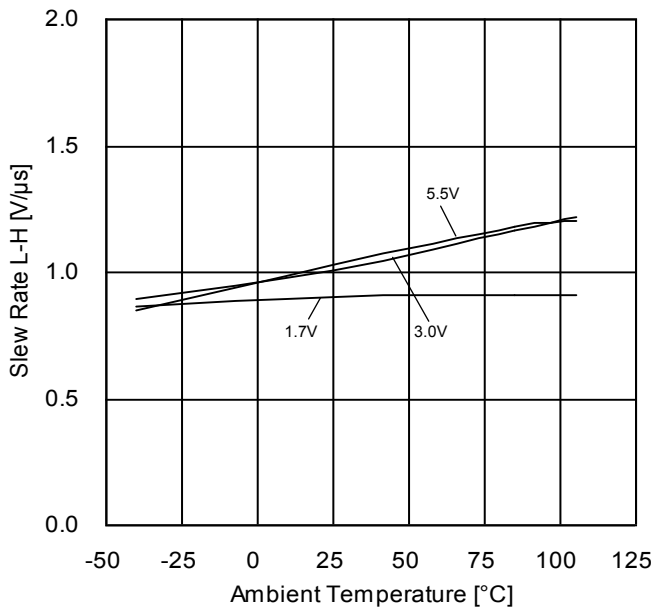

Figure 22.
Slew Rate L-H vs Ambient Temperature

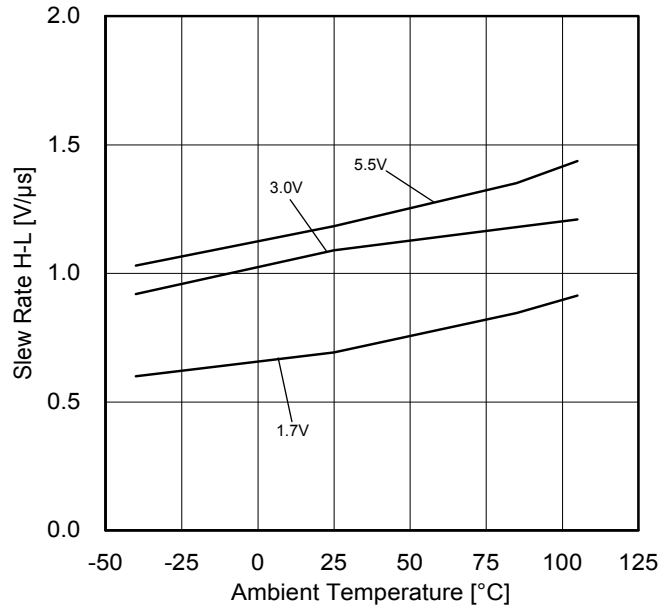

Figure 23.
Slew Rate H-L vs Ambient Temperature

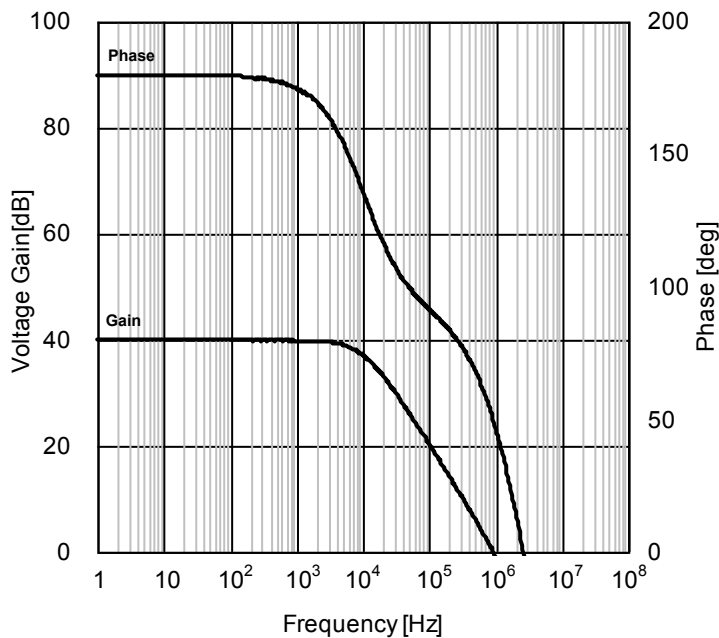

Figure 24.
Voltage Gain · Phase vs Frequency
(VDD=+3V, VSS=0V, T_A=25°C)

(*)The above characteristics are measurements of typical sample, they are not guaranteed.
BU7461G: -40°C to +85°C BU7461SG: -40°C to +105°C

Typical Performance Curves

○BU7462xxx, BU7462Sxxx

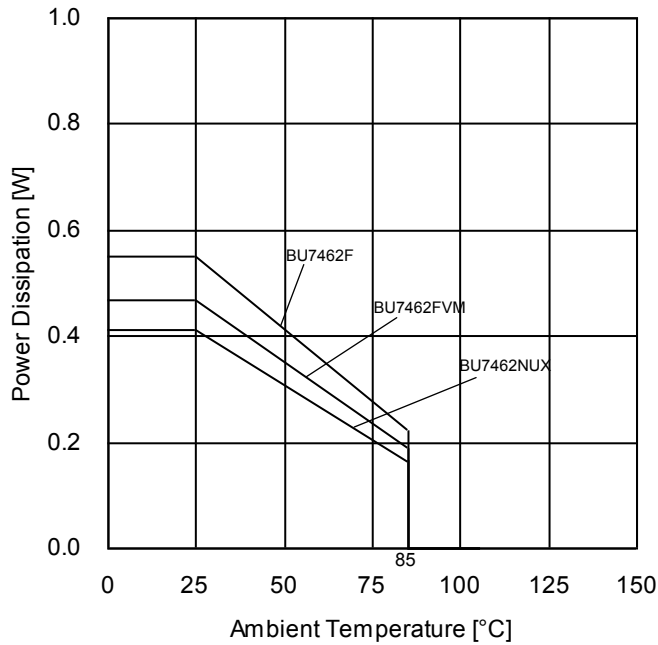

Figure 25.
Power Dissipation vs Ambient Temperature Derating Curve

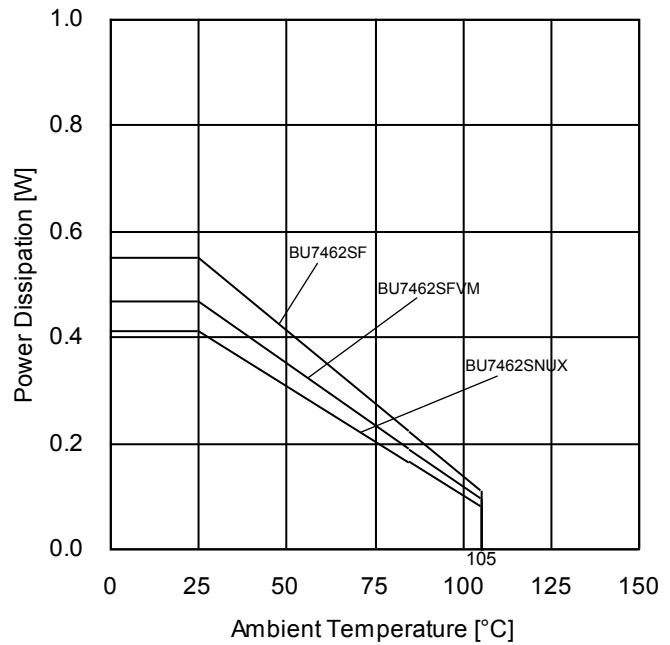

Figure 26.
Power Dissipation vs Ambient Temperature Derating Curve

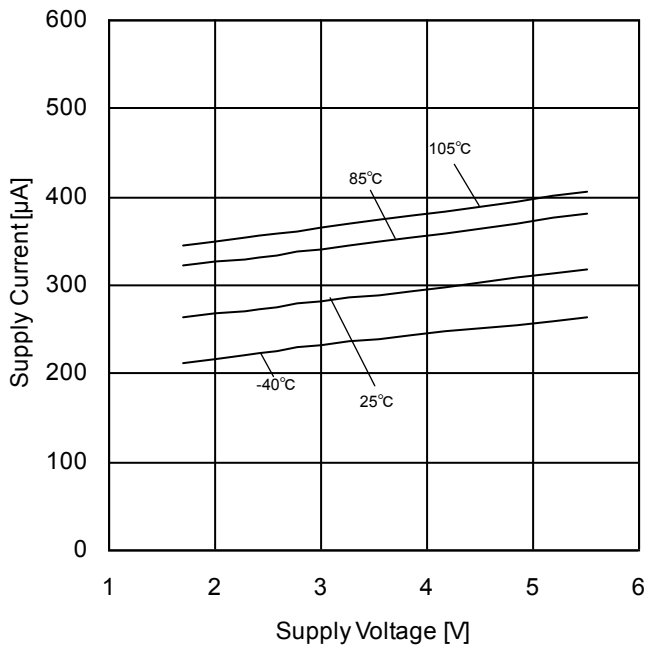

Figure 27.
Supply Current vs Supply Voltage

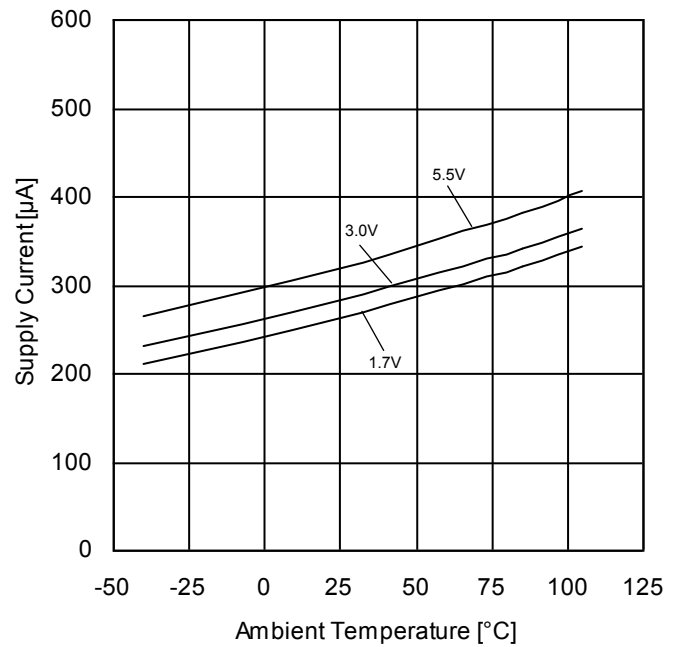

Figure 28.
Supply Current vs Ambient Temperature

(*)The above characteristics are measurements of typical sample, they are not guaranteed.
BU7462xxx: -40°C to +85°C BU7462Sxxx: -40°C to +105°C

Typical Performance Curves – continued

OBU7462xxx, BU7462Sxxx

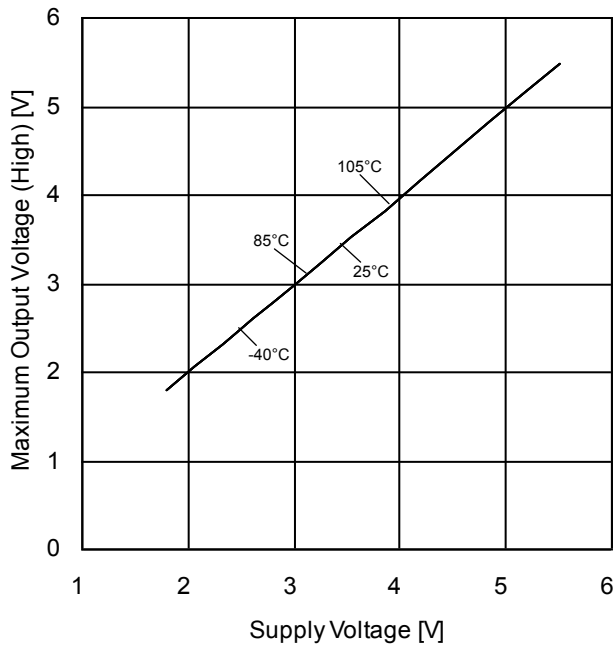

Figure 29.
Maximum Output Voltage (High) vs Supply Voltage
($R_L=10k\Omega$)

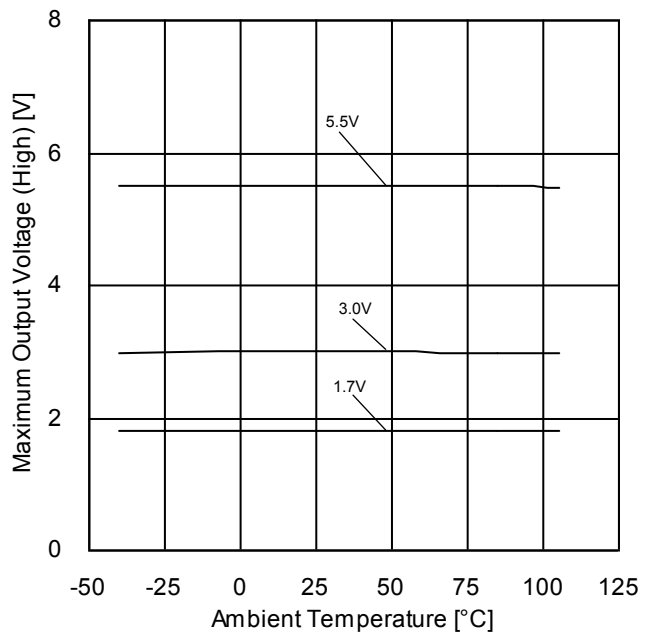

Figure 30.
Maximum Output Voltage (High) vs Ambient Temperature
($R_L=10k\Omega$)

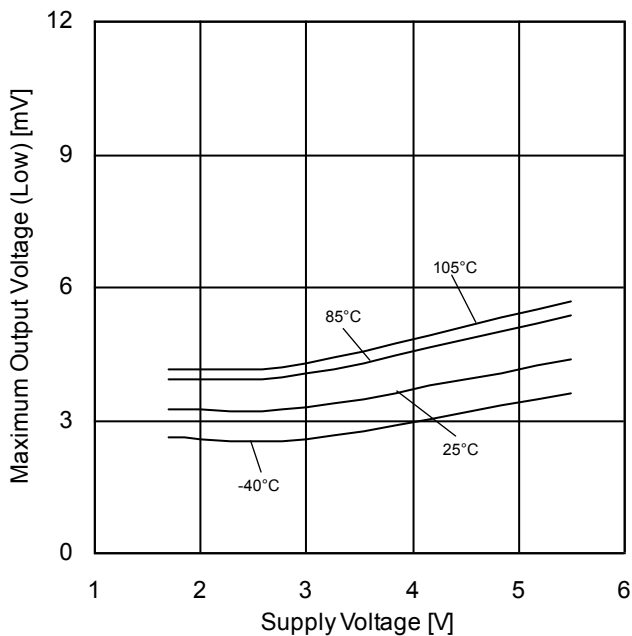

Figure 31.
Maximum Output Voltage (Low) vs Supply Voltage
($R_L=10k\Omega$)

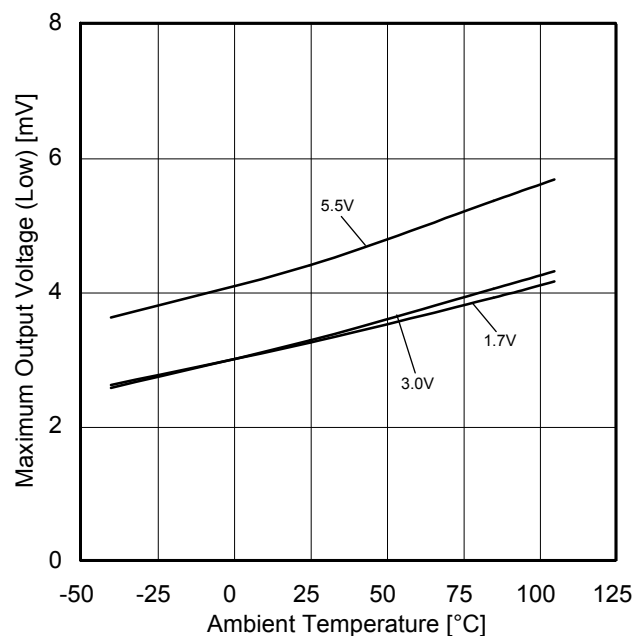

Figure 32.
Maximum Output Voltage (Low) vs Ambient Temperature
($R_L=10k\Omega$)

(*)The above characteristics are measurements of typical sample, they are not guaranteed.
BU7462xxx: -40°C to +85°C BU7462Sxxx: -40°C to +105°C

Typical Performance Curves – continued

OBU7462xxx, BU7462Sxxx

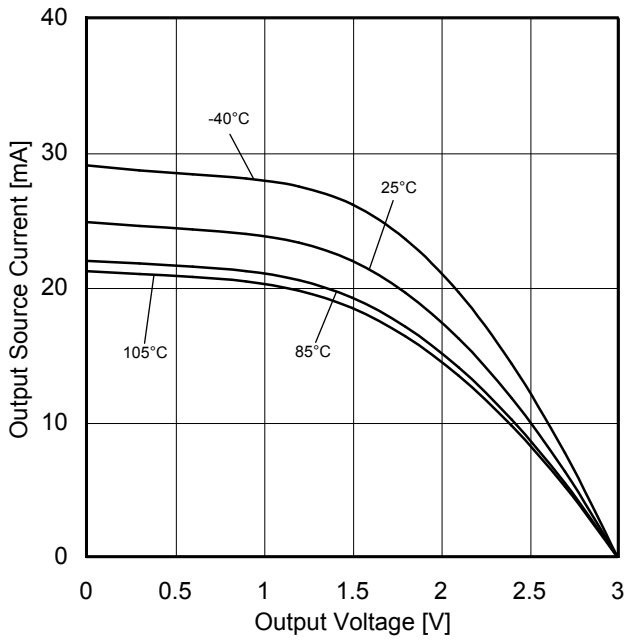

Figure 33.
Output Source Current vs Output Voltage
(VDD=3V)

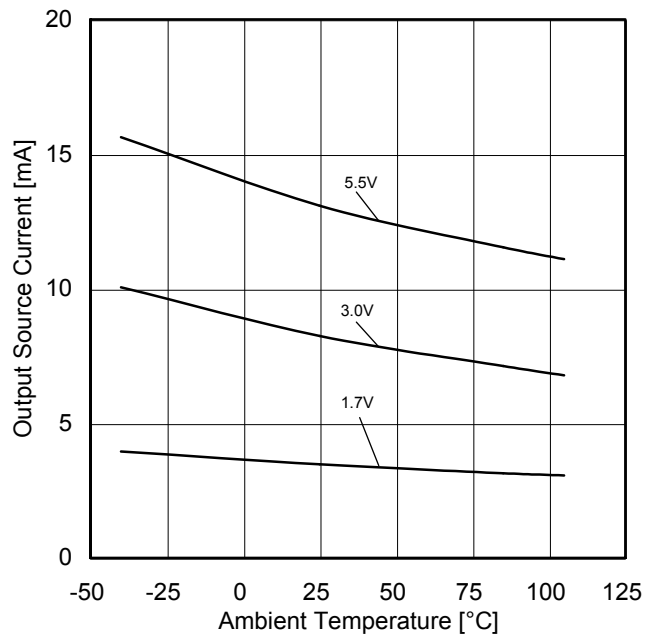

Figure 34.
Output Source Current vs Ambient Temperature
(OUT=VDD-0.4V)

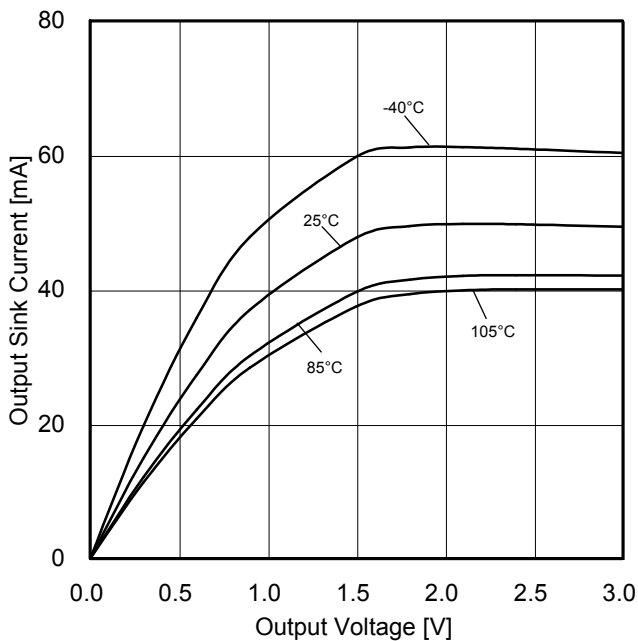

Figure 35.
Output Sink Current vs Output Voltage
(VDD=3V)

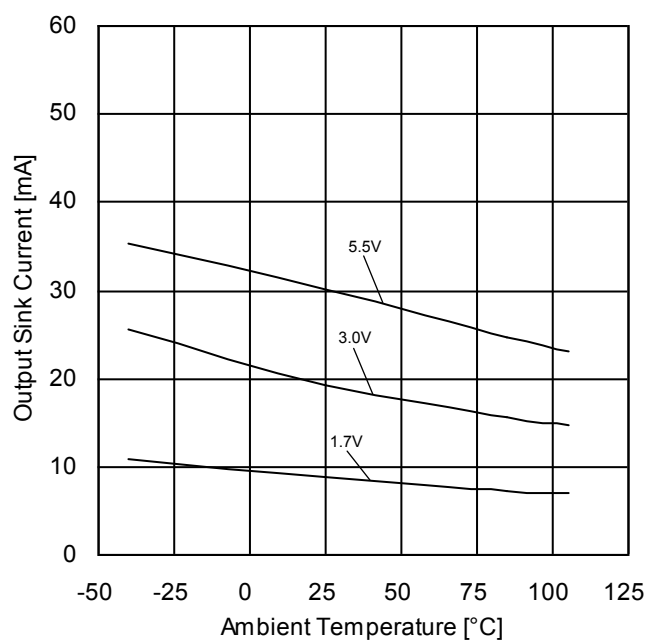

Figure 36.
Output Sink Current vs Ambient Temperature
(OUT=VSS+0.4V)

(*)The above characteristics are measurements of typical sample, they are not guaranteed.
BU7462xxx: -40°C to +85°C BU7462Sxxx: -40°C to +105°C

Typical Performance Curves – continued

OBU7462xxx, BU7462Sxxx

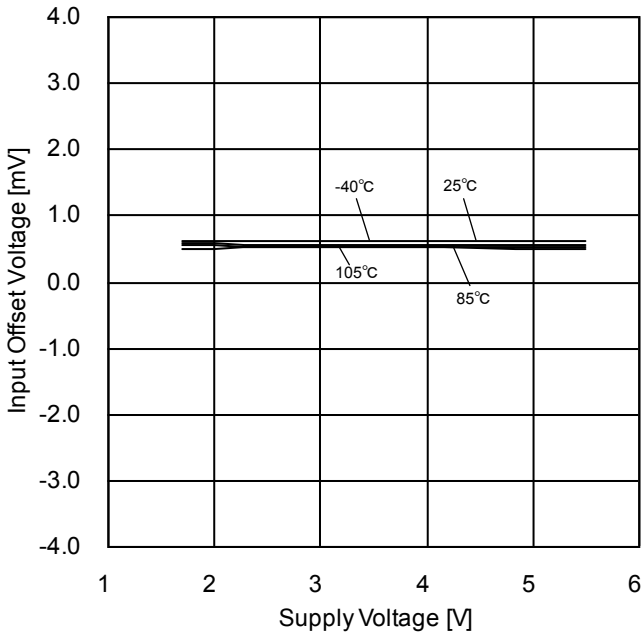

Figure 37.
Input Offset Voltage vs Supply Voltage
($V_{ICM}=V_{DD}-1.2V$, $E_k=-V_{DD}/2$)

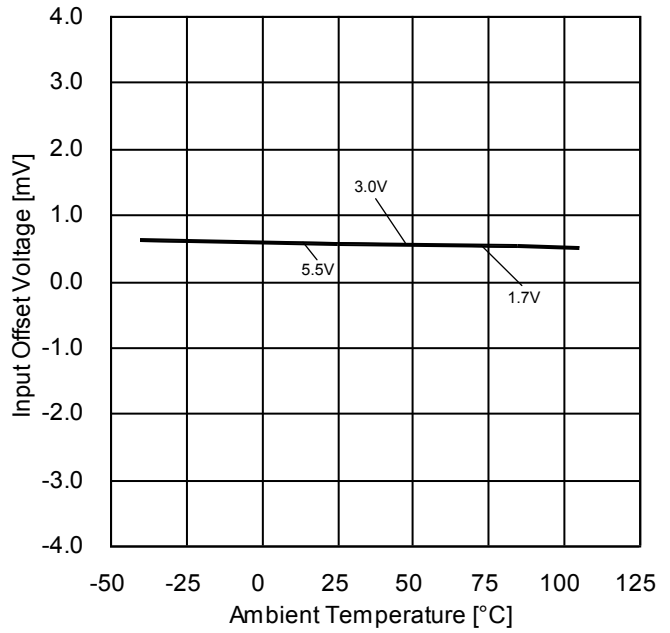

Figure 38.
Input Offset Voltage vs Ambient Temperature
($V_{ICM}=V_{DD}-1.2V$, $E_k=-V_{DD}/2$)

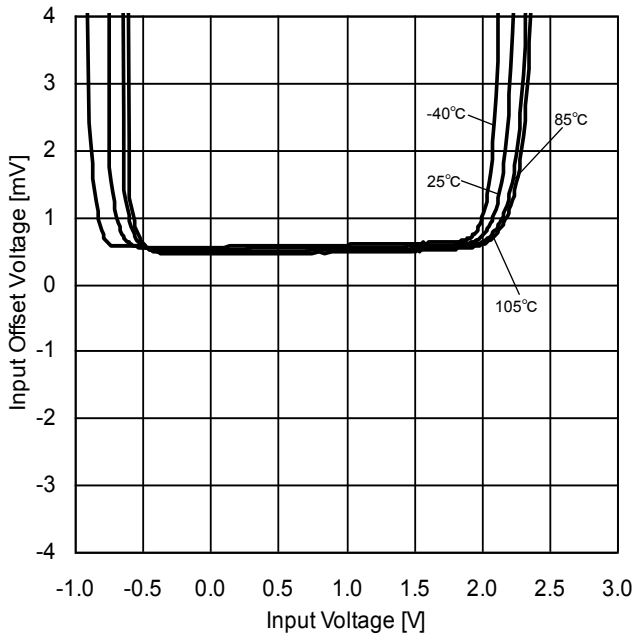

Figure 39.
Input Offset Voltage vs Input Voltage
($V_{DD}=3V$)

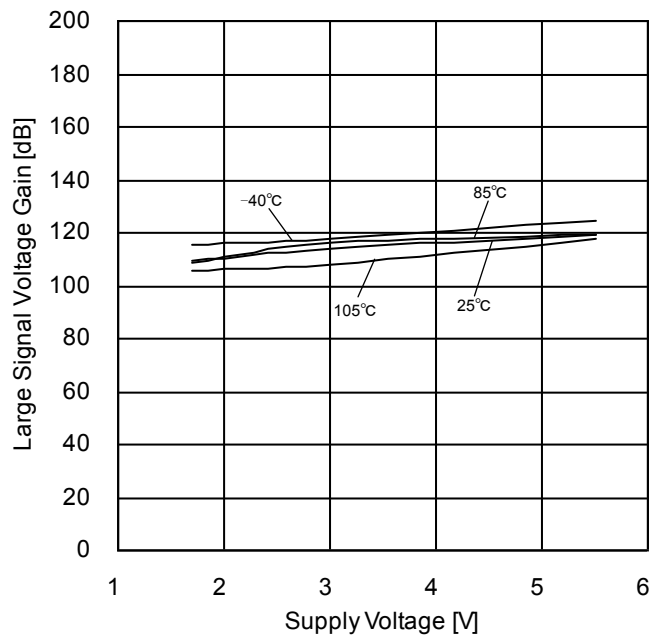

Figure 40.
Large Signal Voltage Gain vs Supply Voltage

(*)The above characteristics are measurements of typical sample, they are not guaranteed.
BU7462xxx: -40°C to +85°C BU7462Sxxx: -40°C to +105°C

Typical Performance Curves – continued

OBU7462xxx, BU7462Sxxx

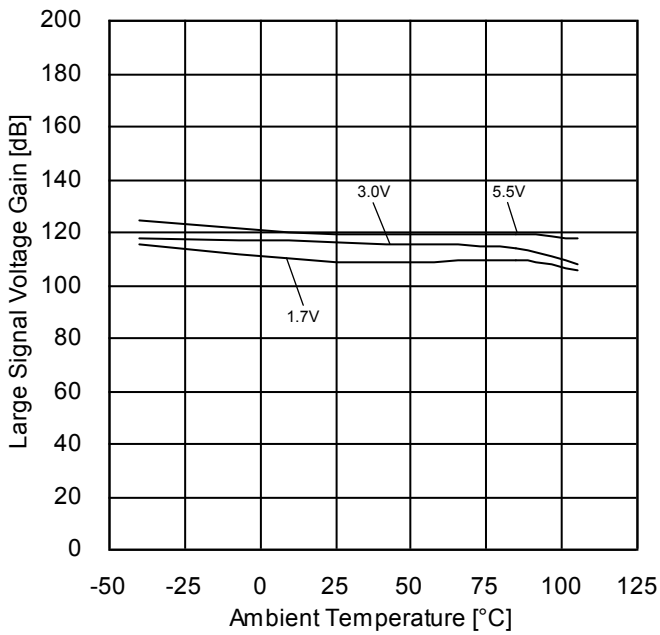

Figure 41. Large Signal Voltage Gain vs Ambient Temperature

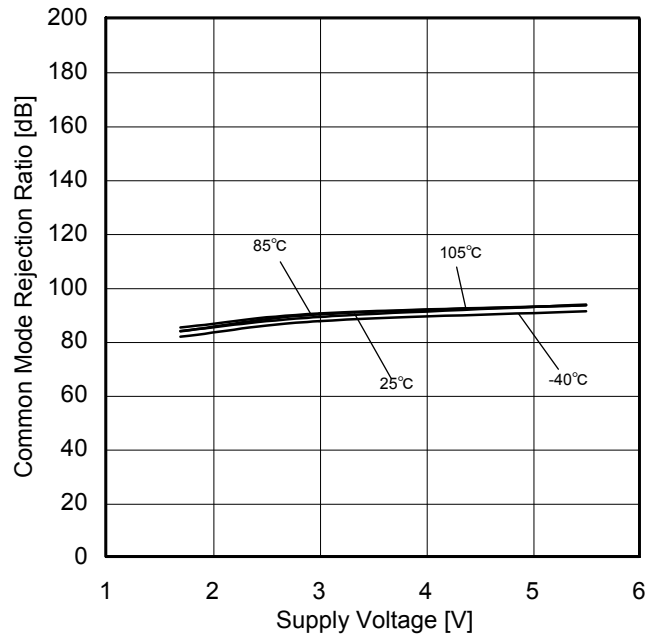

Figure 42. Common Mode Rejection Ratio vs Supply Voltage

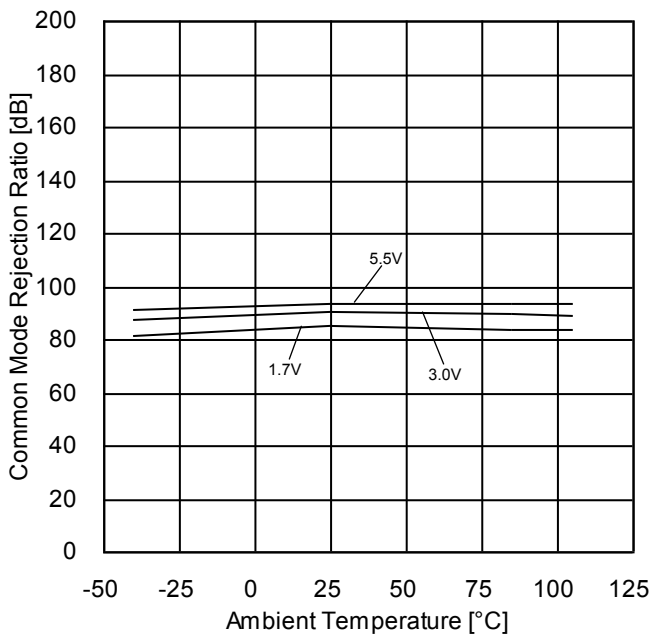

Figure 43. Common Mode Rejection Ratio vs Ambient Temperature

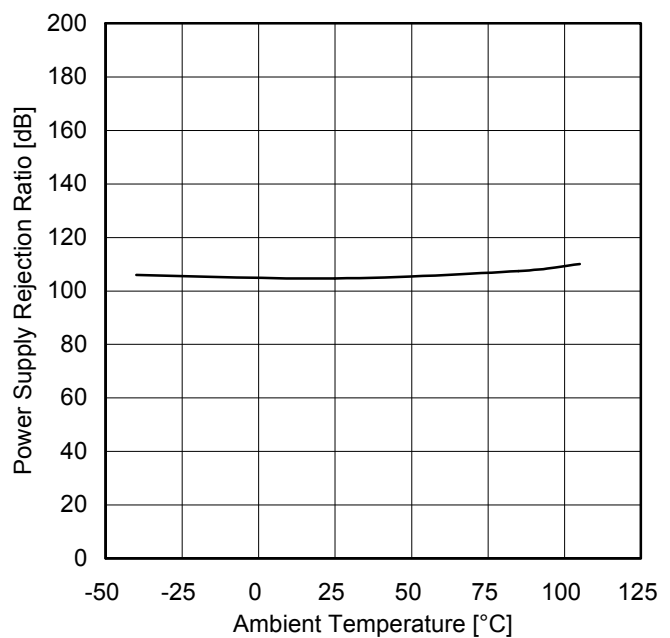

Figure 44. Power Supply Rejection Ratio vs Ambient Temperature

(*)The above characteristics are measurements of typical sample, they are not guaranteed.
 BU7462xxx: -40°C to +85°C BU7462Sxxx: -40°C to +105°C

Typical Performance Curves – continued

OBU7462xxx, BU7462Sxxx

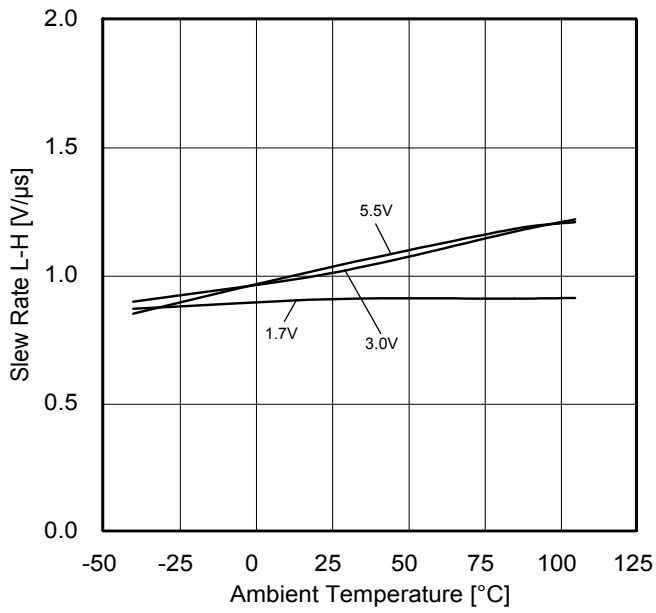

Figure 45.
Slew Rate L-H vs Ambient Temperature

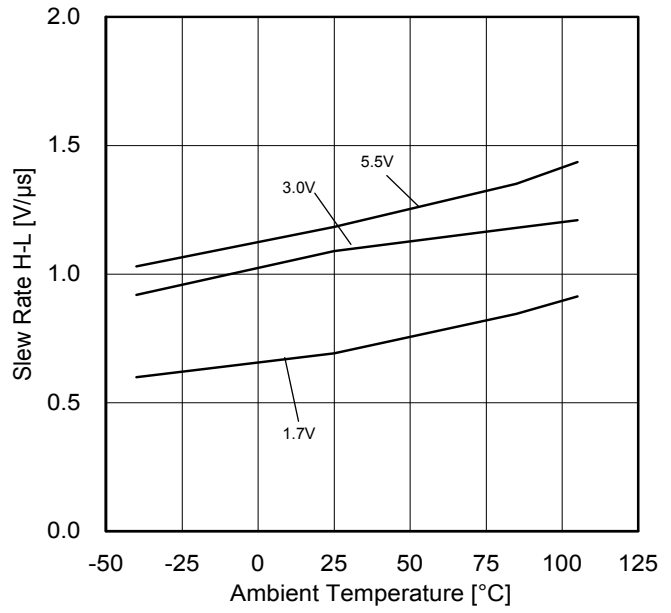

Figure 46.
Slew Rate H-L vs Ambient Temperature

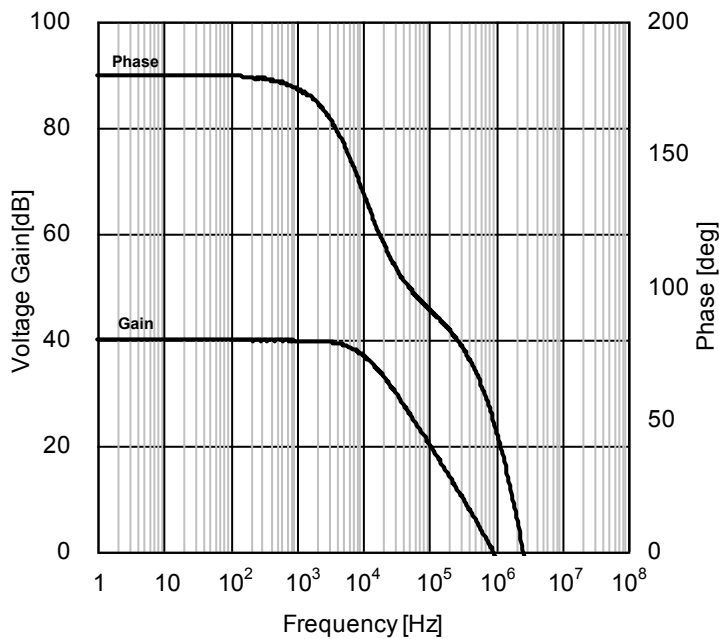

Figure 47.
Voltage Gain · Phase vs Frequency
(VDD=+3V, VSS=0V, T_A=25°C)

(*)The above characteristics are measurements of typical sample, they are not guaranteed.
BU7462xxx: -40°C to +85°C BU7462Sxxx: -40°C to +105°C

Typical Performance Curves

OBU7464F, BU7464SF

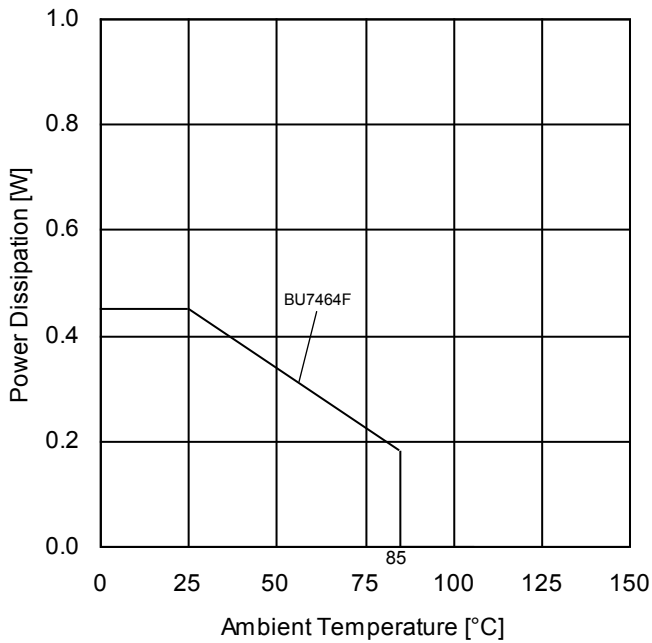

Figure 48.
Power Dissipation vs Ambient Temperature Derating Curve

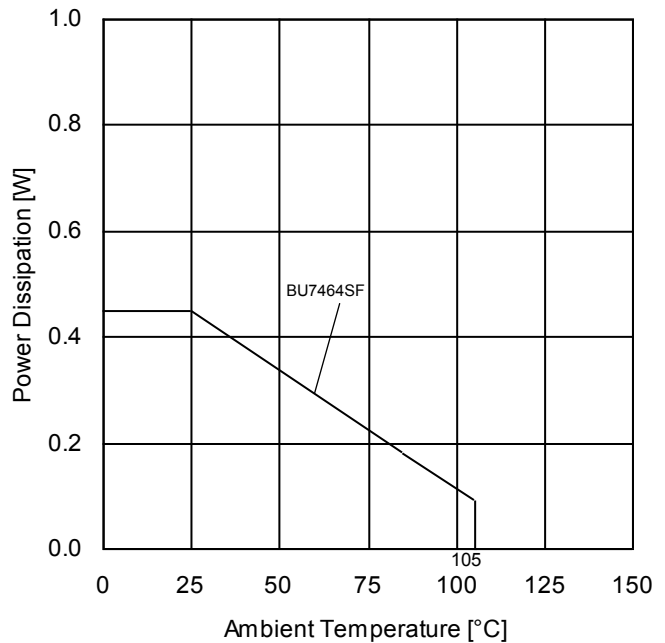

Figure 49.
Power Dissipation vs Ambient Temperature Derating Curve

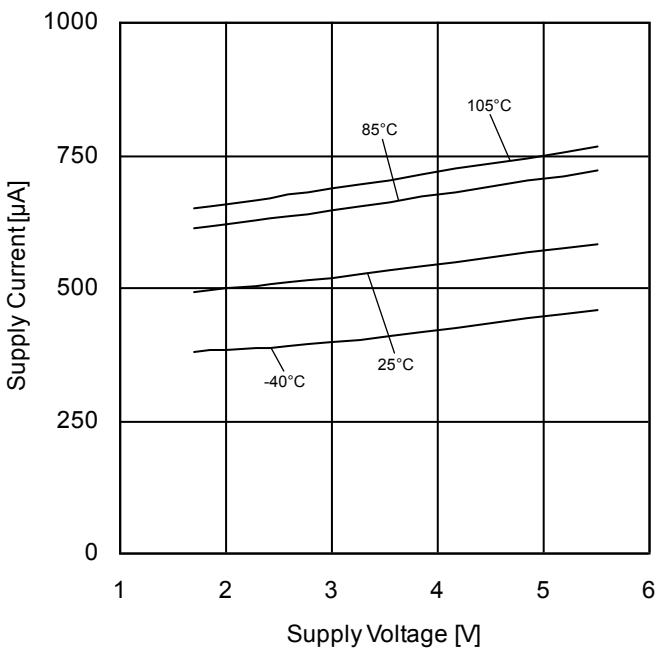

Figure 50.
Supply Current vs Supply Voltage

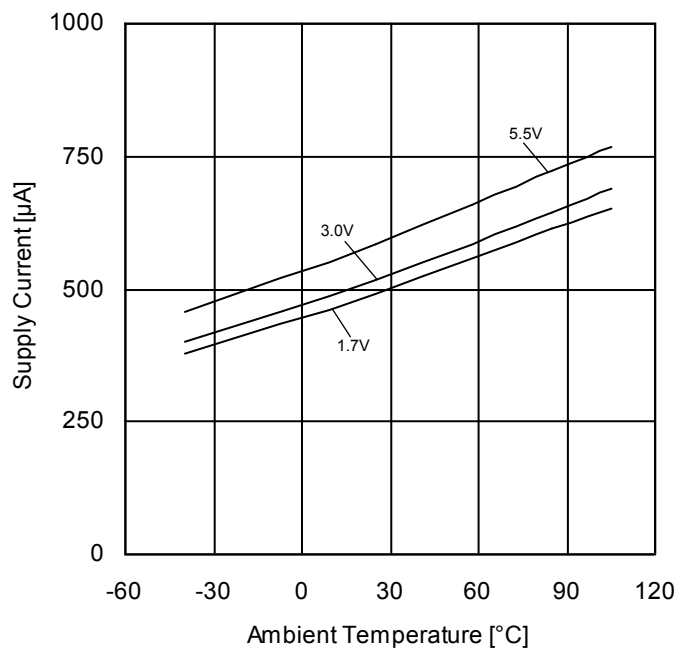

Figure 51.
Supply Current vs Ambient Temperature

(*)The above characteristics are measurements of typical sample, they are not guaranteed.
BU7464F: -40°C to +85°C BU7464SF: -40°C to +105°C

Typical Performance Curves – continued

OBU7464F, BU7464SF

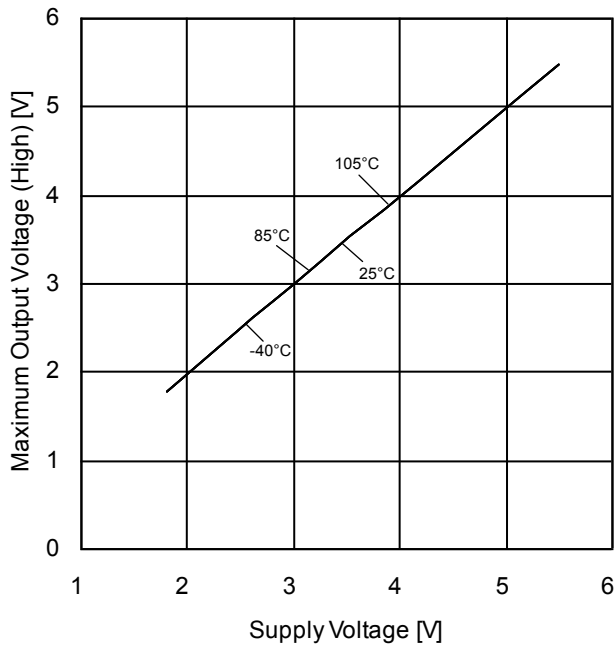

Figure 52.
Maximum Output Voltage (High) vs Supply Voltage
($R_L=10k\Omega$)

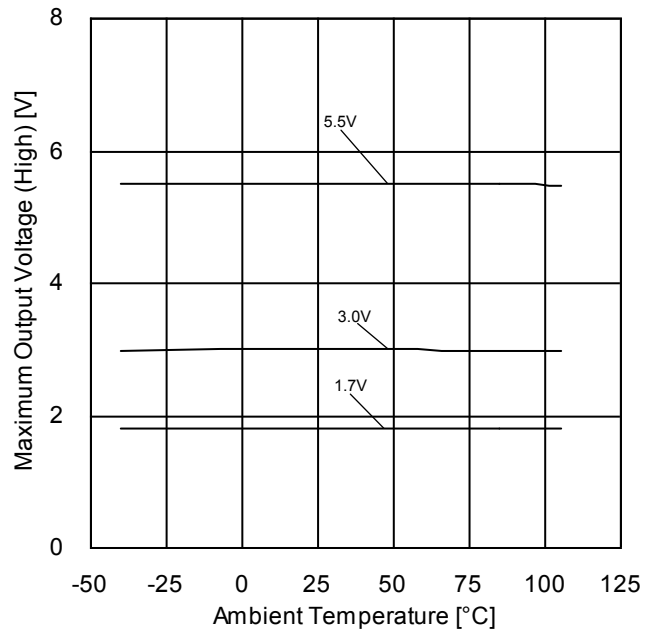

Figure 53.
Maximum Output Voltage (High) vs Ambient Temperature
($R_L=10k\Omega$)

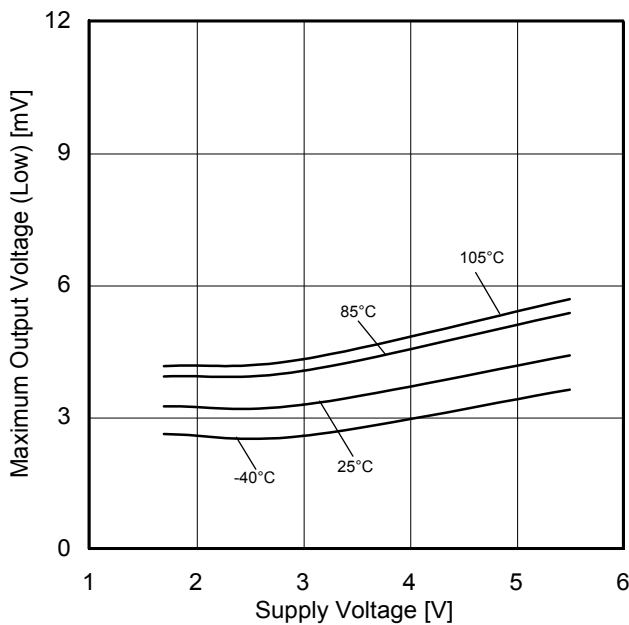

Figure 54.
Maximum Output Voltage (Low) vs Supply Voltage
($R_L=10k\Omega$)

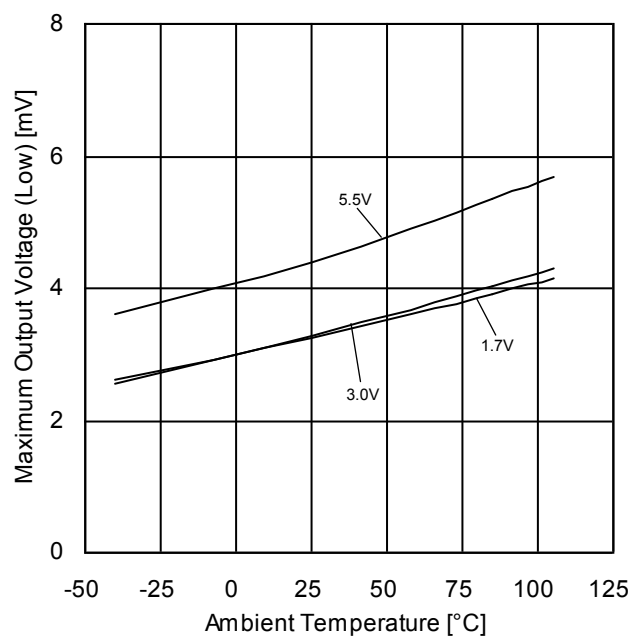

Figure 55.
Maximum Output Voltage (Low) vs Ambient Temperature
($R_L=10k\Omega$)

(*)The above characteristics are measurements of typical sample, they are not guaranteed.
BU7464F: -40°C to +85°C BU7464SF: -40°C to +105°C

Typical Performance Curves – continued

OBU7464F, BU7464SF

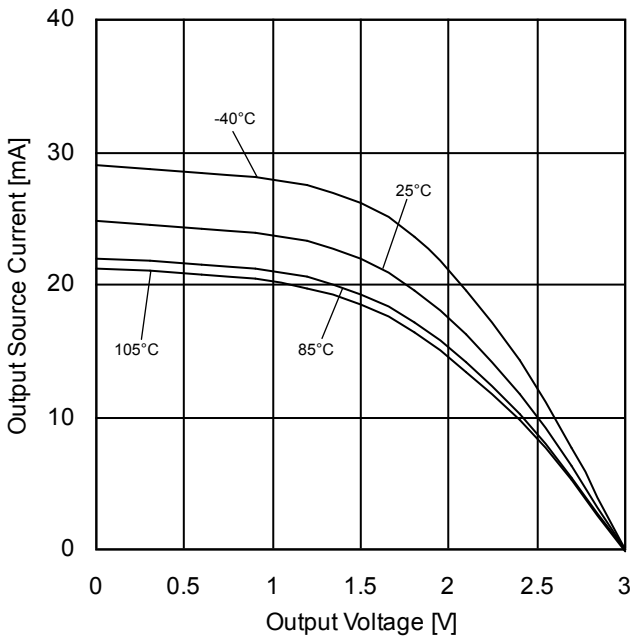

Figure 56.
Output Source Current vs Output Voltage
(VDD=3V)

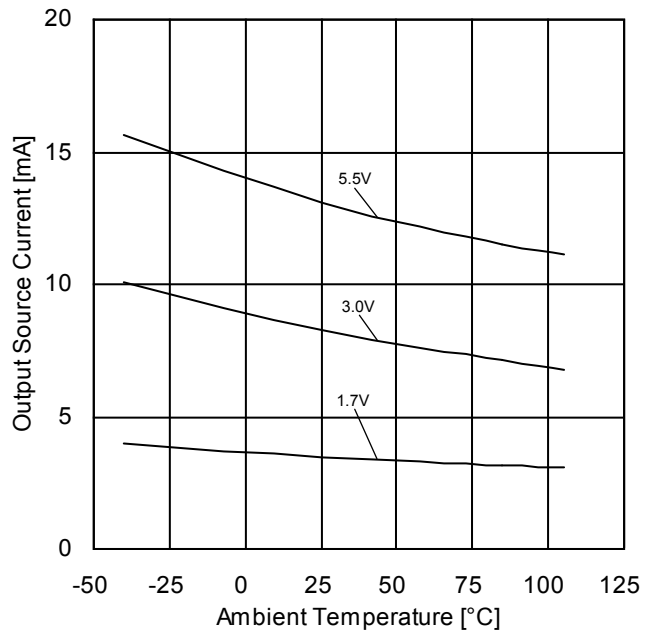

Figure 57.
Output Source Current vs Ambient Temperature
(OUT=VDD-0.4V)

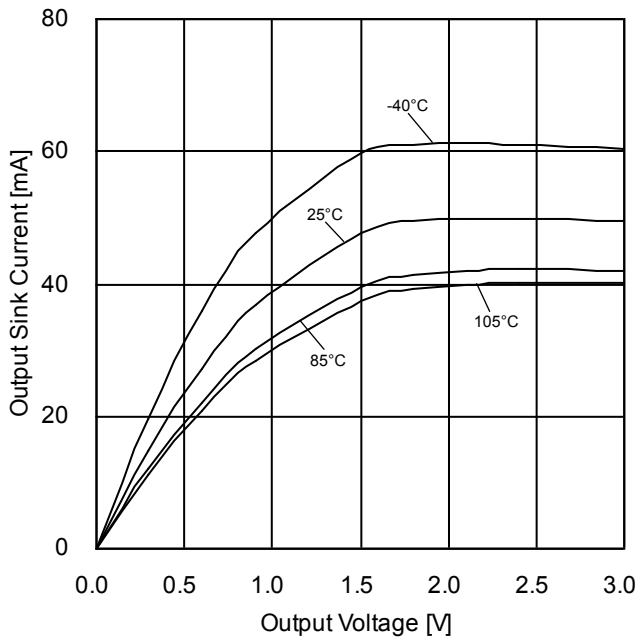

Figure 58.
Output Sink Current vs Output Voltage
(VDD=3V)

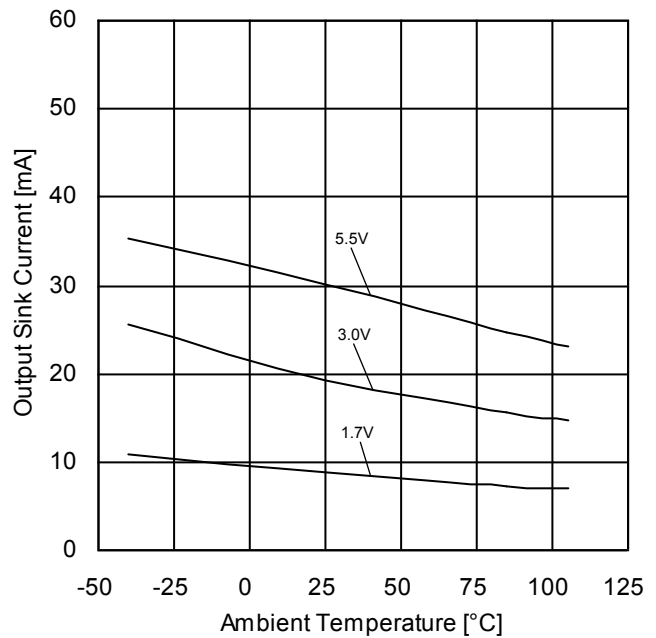

Figure 59.
Output Sink Current vs Ambient Temperature
(OUT=VSS+0.4V)

(*)The above characteristics are measurements of typical sample, they are not guaranteed.
BU7464F: -40°C to +85°C BU7464SF: -40°C to +105°C

Typical Performance Curves – continued

OBU7464F, BU7464SF

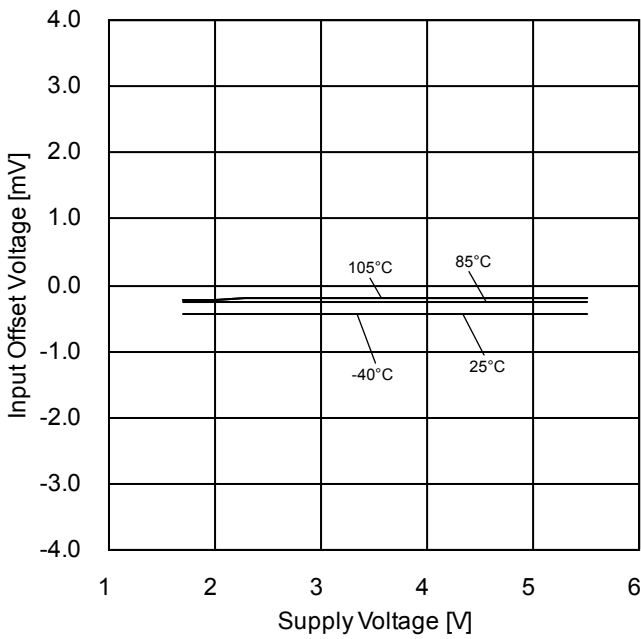

Figure 60.
Input Offset Voltage vs Supply Voltage
($V_{ICM}=V_{DD}-1.2V$, $E_k=-V_{DD}/2$)

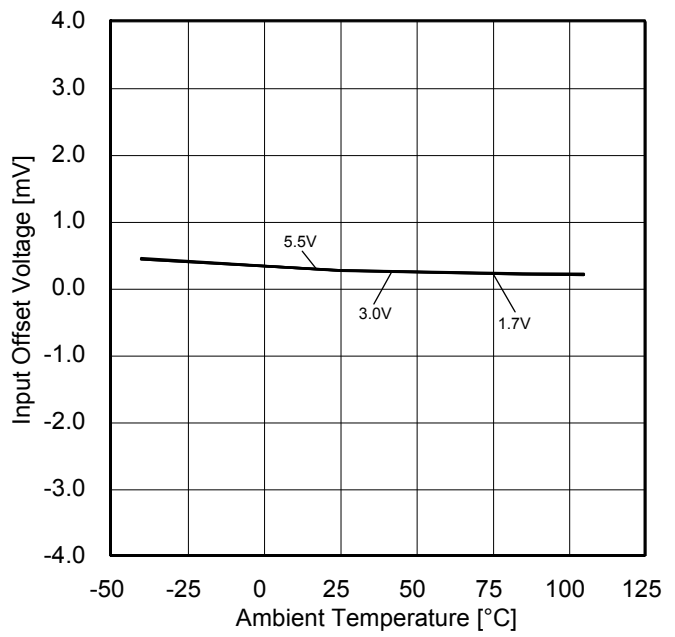

Figure 61.
Input Offset Voltage vs Ambient Temperature
($V_{ICM}=V_{DD}-1.2V$, $E_k=-V_{DD}/2$)

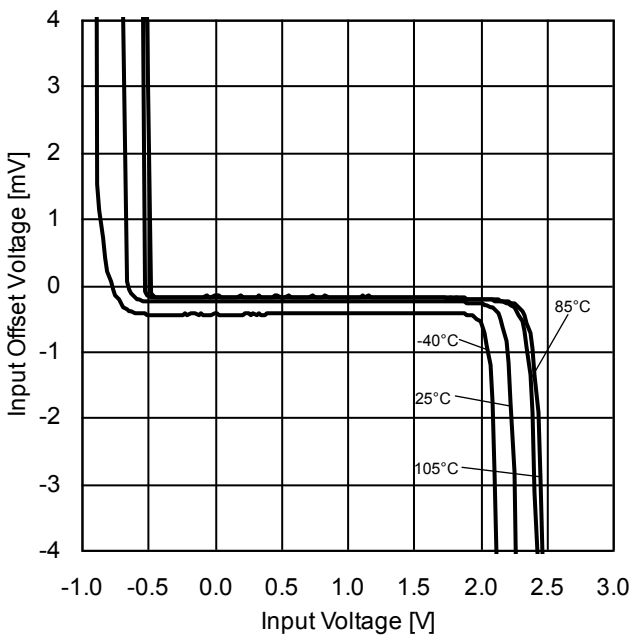

Figure 62.
Input Offset Voltage vs Input Voltage
($V_{DD}=3V$)

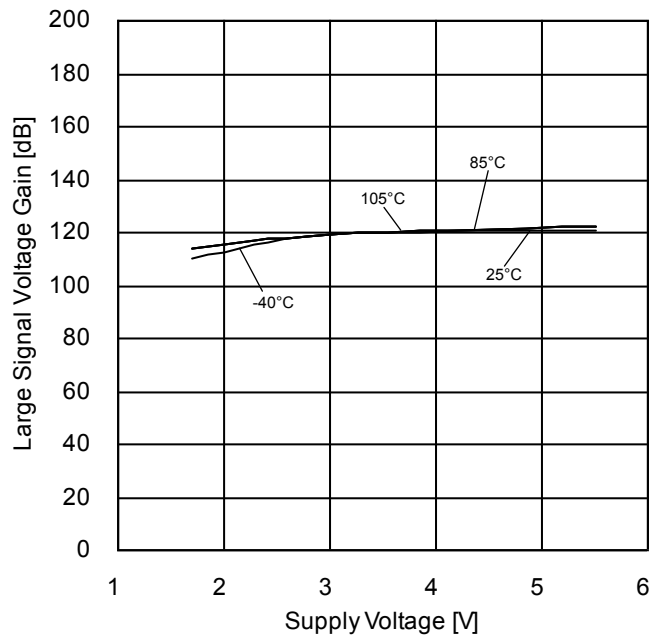

Figure 63.
Large Signal Voltage Gain vs Supply Voltage

(*)The above characteristics are measurements of typical sample, they are not guaranteed.
BU7464F: -40°C to +85°C BU7464SF: -40°C to +105°C

Typical Performance Curves – continued

OBU7464F, BU7464SF

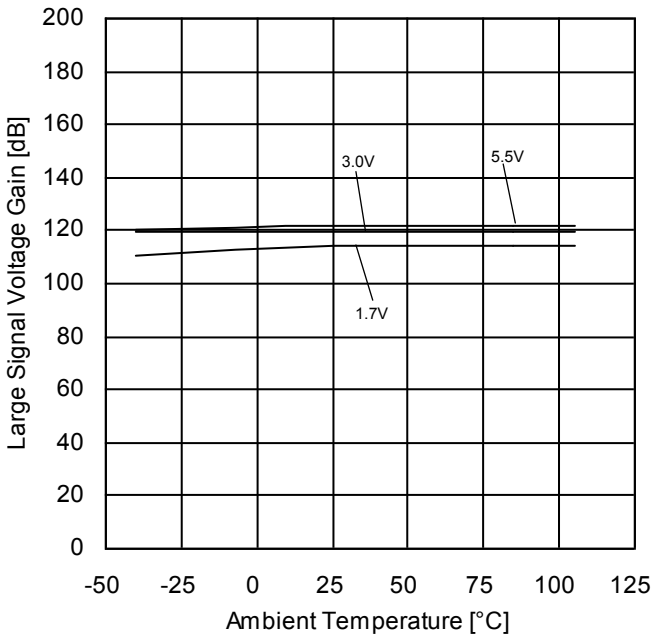

Figure 64.
Large Signal Voltage Gain vs Ambient Temperature

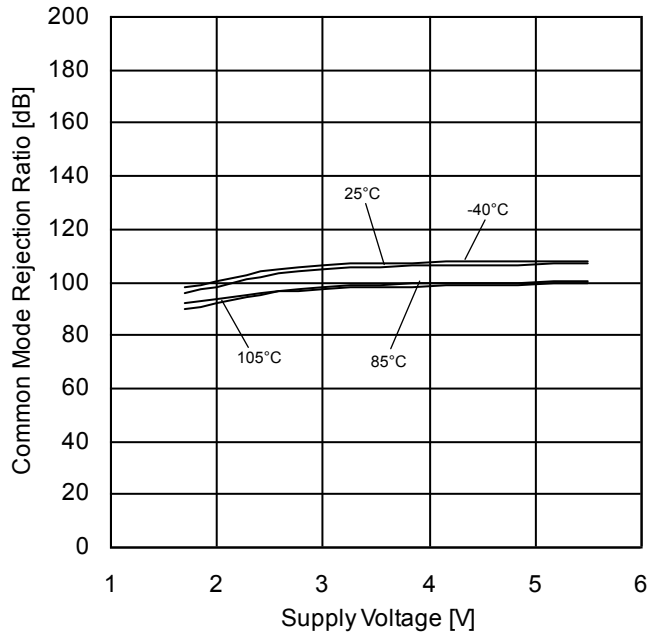

Figure 65.
Common Mode Rejection Ratio vs Supply Voltage

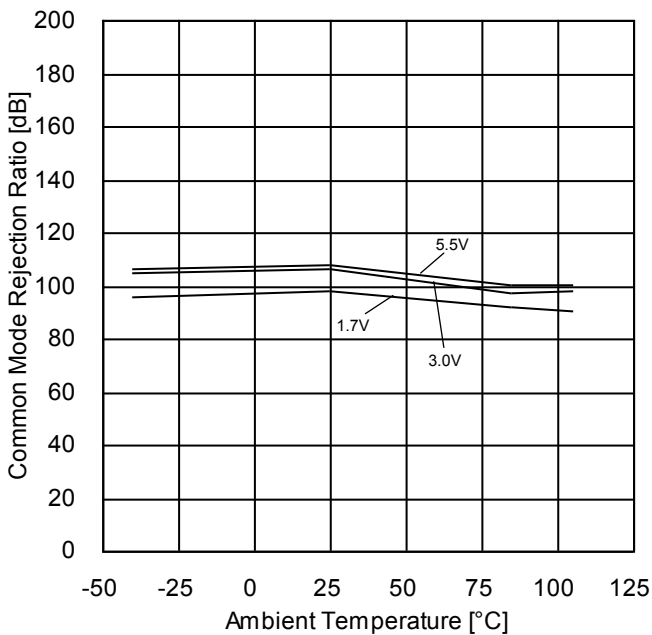

Figure 66.
Common Mode Rejection Ratio vs Ambient Temperature

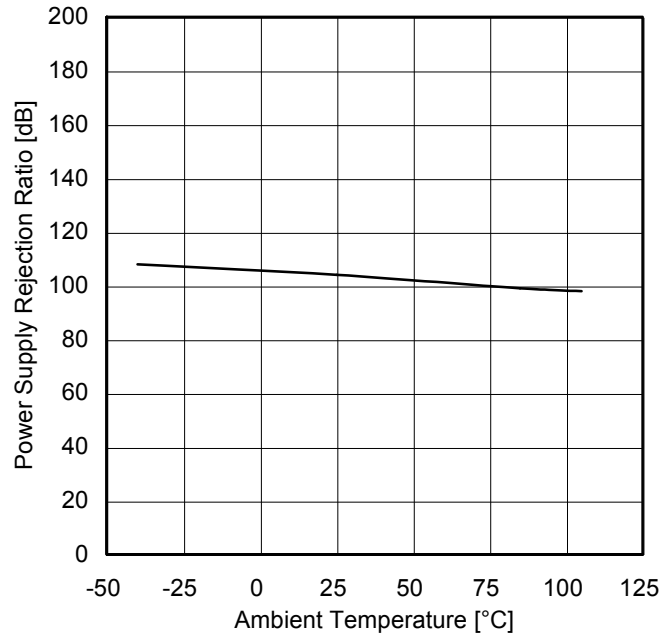

Figure 67.
Power Supply Rejection Ratio vs Ambient Temperature

(*)The above characteristics are measurements of typical sample, they are not guaranteed.
BU7464F: -40°C to +85°C BU7464SF: -40°C to +105°C