



Chipsmall Limited consists of a professional team with an average of over 10 year of expertise in the distribution of electronic components. Based in Hongkong, we have already established firm and mutual-benefit business relationships with customers from,Europe,America and south Asia,supplying obsolete and hard-to-find components to meet their specific needs.

With the principle of “Quality Parts,Customers Priority,Honest Operation,and Considerate Service”,our business mainly focus on the distribution of electronic components. Line cards we deal with include Microchip,ALPS,ROHM,Xilinx,Pulse,ON,Everlight and Freescale. Main products comprise IC,Modules,Potentiometer,IC Socket,Relay,Connector.Our parts cover such applications as commercial,industrial, and automotives areas.

We are looking forward to setting up business relationship with you and hope to provide you with the best service and solution. Let us make a better world for our industry!



Contact us

Tel: +86-755-8981 8866 Fax: +86-755-8427 6832

Email & Skype: info@chipsmall.com Web: www.chipsmall.com

Address: A1208, Overseas Decoration Building, #122 Zhenhua RD., Futian, Shenzhen, China



Bridgelux RS Array Series

Product Data Sheet DS16

BXRA – W3500, - W5700, - N4000, - N6300, - C5000, - C8000

Introduction

The Bridgelux family of LED Array products delivers high performance, compact and cost-effective solid-state lighting solutions to serve the general lighting market. These products combine the higher efficacy, lifetime, and reliability benefits of LEDs with the light output levels of many conventional lighting sources. The Bridgelux RS Array Series has been specified to enable lamp and luminaire designs with comparable performance to existing high wattage CFL and HID conventional light sources for retail, commercial, industrial and outdoor/street lighting applications. The CFL and HID light sources cannot be readily dimmed; Bridgelux Arrays are extremely well equipped for all types of light-on-demand applications, where they can be instantaneously and smoothly dimmed up or down without any effect on lifetime.

The Bridgelux RS Array series provides a high performance alternative to conventional solid state solutions, delivering between 3000 and 8500 lumens under application conditions in warm, neutral and cool white color temperatures. These compact high flux density light sources deliver uniform high quality illumination without pixilation or the multiple shadow effect caused by LED component based solutions, enabling excellent beam control for precision lighting. To simplify system design for appropriate light output, Bridgelux LED Arrays are specified to deliver performance under typical use conditions.

These integrated plug and play solutions reduce system complexity and enable miniaturized cost-effective lamp and luminaire designs. Luminaire designs incorporating these LED Arrays deliver system level performance comparable to that of 42-55 Watt CFL, 35-90 Watt low pressure sodium, 70-150 Watt high pressure sodium or 70-200 Watt metal halide based luminaires and feature increased system level and service life. Typical applications include retail lighting, commercial down lights, high bay, outdoor and street lights, and entertainment lighting.

Features

- Compact high flux density light source
- Uniform high quality illumination
- Streamlined thermal path
- Energy Star / ANSI compliant binning structure
- More energy efficient than incandescent, halogen and fluorescent lamps
- Low voltage DC operation
- Instant light with unlimited dimming
- 5-year warranty
- RoHS compliant and Pb free

Benefits

- Enhanced optical control
- Clean white light without pixilation
- Significantly reduced thermal resistance and increased operating temperatures
- Uniform consistent white light
- Lower operating costs
- Increased safety
- Easy to use with daylight and motion detectors to enable increased energy savings
- Reduced maintenance costs
- Environmentally friendly, no disposal issue



Table of Contents	Page
Product Nomenclature	3
Average Lumen Maintenance Characteristics	3
Environmental Compliance	3
UL Recognition	4
Minor Product Change Policy	4
Cautionary Statements	4
Case Temperature Measurement Point	5
Flux Characteristics	6
Optical Characteristics	7
Electrical Characteristics	8
Absolute Minimum and Maximum Ratings	9
Typical Performance at Alternative Drive Currents	10
Mechanical Dimensions	12
Typical Radiation Pattern	13
Wavelength Characteristics at Rated Test Current, $T_j=25^{\circ}\text{C}$	14
Typical Relative Luminous Flux vs. Current, $T_j=25^{\circ}\text{C}$	16
Typical Light Output Characteristics vs. Temperature	17
Typical Chromaticity Characteristics vs. Temperature	18
Typical Forward Current Characteristics at $T_j = 25^{\circ}\text{C}$	19
Current Derating Curves	20
Product Binning	21
Color Binning Information	22
Mechanical Assembly and Handling	25
Product Packaging and Labeling	27
Packaging Tube Design	30
Design Resources	31

Product Nomenclature

The part number designation for Bridgelux LED Arrays is explained as follows:

B X R A – A B C D E – R R R R R

Where:

B X R A – designates product family

A – designates color, C for Cool White, N for Neutral White and W for Warm White

B C D – designates LED Array product flux, 300 for a 3000 lumen array, etc

E – designates product family

R R R R R – used to designate product options, 00000 by default

The base product part number (BXRA-ABCDE) is indicated on each individual unit, printed on the bottom of the LED Array.

Average Lumen Maintenance Characteristics

Bridgelux projects that its family of LED Array products will deliver, on average, greater than 70% lumen maintenance after 50,000 hours of operation at the rated forward test current. This performance assumes constant current operation with case temperature maintained at or below 70°C. For use beyond these typical operating conditions please consult your Bridgelux sales representative for further assistance.

These projections are based on a combination of package test data, semiconductor chip reliability data, a fundamental understanding of package related degradation mechanisms, and performance observed from products installed in the field using Bridgelux die technology. Bridgelux conducts lumen maintenance tests per LM80. Observation of design limits is required in order to achieve this projected lumen maintenance.

Environmental Compliance

Bridgelux is committed to providing environmentally friendly products to the solid-state lighting market. Bridgelux LED Arrays are compliant to the European Union directives on the restriction of hazardous substances in electronic equipment, namely the RoHS directive. Bridgelux will not intentionally add the following restricted materials to LED Array products: lead, mercury, cadmium, hexavalent chromium, polybrominated biphenyls (PBB) or polybrominated diphenyl ethers (PBDE).

UL Recognition

Bridgelux has UL Recognition for all the LED Array products listed in this data sheet. Please refer to the UL file E333389 for the latest list of UL Recognized Arrays. Bridgelux uses UL Recognized materials with suitable flammability ratings in the LED Array to streamline the process for customers to secure UL listing of the final luminaire product. Bridgelux recommends that luminaires are designed with a Class 2 Driver to facilitate the UL listing process.

Minor Product Change Policy

The rigorous qualification testing on products offered by Bridgelux provides performance assurance. Slight cosmetic changes that do not affect form, fit, or function may occur as Bridgelux continues product optimization.

Cautionary Statements

CAUTION: CONTACT WITH OPTICAL AREA

Contact with the resin area should be avoided. Applying stress to the resin area can result in damage to the product.

CAUTION: EYE SAFETY

Eye safety classification for the use of Bridgelux LED Arrays is in accordance with IEC specification EN62471; Photobiological Safety of Lamps and Lamp Systems. Bridgelux LED Arrays are classified as Risk Group 1 (Low Risk) when operated at or below their rated test current. Please use appropriate precautions. It is important that employees working with LEDs are trained to use them safely.

CAUTION: RISK OF BURN

Do not touch the LED Array or resin area during operation. Allow the LED Array to cool for a sufficient period of time before handling. The LED Array may reach elevated temperatures such that it can burn skin when touched.

Case Temperature Measurement Point

A case temperature measurement point location is included on the top surface of the Bridgelux LED Arrays. The location of this measurement point is indicated in the mechanical dimensions section of this data sheet.

The purpose of this measurement point is to allow the user access to a measurement point closely linked to the true case temperature on the back surface of the LED Array. Once the LED Array is installed, it is challenging to measure the back surface of the array, or true case temperature. Measuring the top surface of the product can lead to inaccurate results due to the poor thermal conductivity of the top layers of the array such as the solder mask and other materials.

Bridgelux has provided the case temperature measurement location in a manner which closely ties it to the true case temperature of the LED Array under steady state operation. Deviations between thermal measurements taken at the point indicated and the back of the LED Array differ by less than 1°C, providing a robust method to testing thermal operation once the product is installed.

Flux Characteristics

Table 1: Flux Characteristics

Color	ANSI CCT (K)	Part Number	CRI	Typical Luminous Flux ϕ_v (lm), $T_{case}=60^{\circ}C$ _[3]	Minimum Luminous Flux ϕ_v (lm), $T_j=25^{\circ}C$ ^[1]	Typical Luminous Flux ϕ_v (lm), $T_j=25^{\circ}C$	Test Current (mA) ^[2]
Warm White	2700K	BXRA-W3500-00S0E	80	3300	3300	3700	2100
	2700K	BXRA-W3500-00S0G	90	3000	3000	3300	2100
	2700K	BXRA-W5700-00S0E	80	5200	5200	5800	2800
	2700K	BXRA-W5700-00S0G	90	4700	4700	5200	2800
	3000K	BXRA-W3500-00Q0E	80	3600	3600	4000	2100
	3000K	BXRA-W3500-00Q0G	90	3250	3250	3600	2100
	3000K	BXRA-W5700-00Q0E	80	5700	5700	6300	2800
	3000K	BXRA-W5700-00Q0G	90	5100	5100	5650	2800
Neutral White	4000K	BXRA-N4000-00L0E	80	4000	4000	4400	2100
	4000K	BXRA-N6300-00L0E	80	6300	6300	7000	2800
Cool White	5600K	BXRA-C5000-00E0C	70	5000	5000	5600	2100
	5600K	BXRA-C8000-00E0C	70	7900	7900	8800	2800

Notes for Table 1:

1. Bridgelux maintains a $\pm 7\%$ tolerance of flux measurements.
2. Parts are tested in pulsed conditions, $T_j = 25^{\circ}C$. Pulse width is 10 ms at rated test current.
3. Typical performance when driven with direct current using Bridgelux test set-up. Please contact a Bridgelux sales representative for additional details

Optical Characteristics

Table 2: Optical Characteristics

Color	ANSI CCT (K)	Part Number	Color Temperature (CCT) ^{[1],[2],[3]}			Minimum Color Rendering Index ^[4]	Typical Viewing Angle (Degrees) 2 θ½ ^[6]	Typical Center Beam Candle Power ^[5] (cd)
			Min	Typ	Max			
Warm White	2700K	BXRA-W3500-00S0E	2580 K	2725 K	2870 K	80	120	1175
	2700K	BXRA-W3500-00S0G	2580 K	2725 K	2870 K	90	120	1050
	2700K	BXRA-W5700-00S0E	2580 K	2725 K	2870 K	80	120	1850
	2700K	BXRA-W5700-00S0G	2580 K	2725 K	2870 K	90	120	1660
	3000K	BXRA-W3500-00Q0E	2870 K	3045 K	3220 K	80	120	1275
	3000K	BXRA-W3500-00Q0G	2870 K	3045 K	3220 K	90	120	1150
	3000K	BXRA-W5700-00Q0E	2870 K	3045 K	3220 K	80	120	2000
	3000K	BXRA-W5700-00Q0G	2870 K	3045 K	3220 K	90	120	1800
Neutral White	4000K	BXRA-N4000-00L0E	3700 K	4000 K	4250 K	80	120	1400
	4000K	BXRA-N6300-00L0E	3700 K	4000 K	4250 K	80	120	2200
Cool White	5600K	BXRA-C5000-00E0C	5310 K	5665 K	6020 K	70	120	1780
	5600K	BXRA-C8000-00E0C	5310 K	5665 K	6020 K	70	120	2800

Notes for Table 2:

1. Parts are tested in pulsed conditions, T_j = 25°C. Pulse width is 10 ms at rated test current.
2. Refer to Flux Characteristic Table for test current data.
3. Product is binned for color in x y coordinates.
4. Higher CRI options available upon request.
5. Center beam candle power is a calculated value based on lambertian radiation pattern at nominal test current.
6. Viewing angle is the off axis angle from the centerline where I_v is ½ of the peak value.

Electrical Characteristics

Table 3: Electrical Characteristics

Color	Base Part Number ^[1]	Forward Voltage V _f (V) ^[2]			Test Current (mA) ^[3]	Typical Temperature Coefficient of Forward Voltage (mV/°C) ΔV _f /ΔT _j	Typical Thermal Resistance Junction to Case (°C/W) R _{θ j-c}
		Min	Typ	Max			
Warm White	BXRA-W3500-XXXXX	21.9	24.6	27.1	2100	-8 to -24	0.2
	BXRA-W5700-XXXXX	27.8	30.9	34.0	2800	-10 to -30	0.2
Neutral White	BXRA-N4000-XXXXX	21.9	24.6	27.1	2100	-8 to -24	0.2
	BXRA-N6300-XXXXX	27.8	30.9	34.0	2800	-10 to -30	0.2
Cool White	BXRA-C5000-XXXXX	21.9	24.6	27.1	2100	-8 to -24	0.2
	BXRA-C8000-XXXXX	27.8	30.9	34.0	2800	-10 to -30	0.2

Notes for Table 3:

1. XXXXX indicates specification applies to all versions with base number.
2. Parts are tested in pulsed conditions, T_j = 25°C. Pulse width is 10 ms at rated test current.
3. Bridgelux maintains a tester tolerance of ± 0.10 V on forward voltage measurements.

Absolute Minimum and Maximum Ratings

Table 4: Minimum and Maximum Current and Reverse Voltage Ratings

Part Number	Maximum DC Forward Current (mA)	Minimum DC Forward Current (mA) ^[2]	Maximum Peak Pulsed Current (mA) ^[3]	Maximum Reverse Voltage (Vr) ^[1]
BXRA-W3500-XXXXX	3000	1200	4000	-40 Volts
BXRA-W5700-XXXXX	3750	1500	5000	-50 Volts
BXRA-N4000-XXXXX	3000	1200	4000	-40 Volts
BXRA-N6300-XXXXX	3750	1500	5000	-50 Volts
BXRA-C5000-XXXXX	3000	1200	4000	-40 Volts
BXRA-C8000-XXXXX	3750	1500	5000	-50 Volts

Notes for Table 4:

1. Light emitting diodes are not designed to be driven in reverse voltage.
2. Driving these high current devices at low currents can result in variations in performance. For low current operation pulse width modulation is recommended.
3. Bridgelux recommends a maximum duty cycle of 10% when operating LED Arrays at the maximum peak pulsed current specified.

Table 5: Maximum Ratings

Parameter	Maximum Rating
LED Junction Temperature	150°C
Storage Temperature	-40°C to +105°C
Operating Case Temperature	105°C
Soldering Temperature	3.5 seconds, 350°C or lower

Typical Performance at Alternative Drive Currents

The Bridgelux LED Arrays are tested and binned against the specifications shown in Tables 1, 2 and 3. Customers also have options to drive the LED Arrays at alternative drive currents dependent on the specific application. The typical performance at any drive current can be derived from the flux vs. current characteristics shown in Figure 6 and from the current vs. voltage characteristics shown in Figure 10. The typical performance at common drive currents is also summarized in Table 6.

Table 6: Typical Product Performance at Alternative Drive Currents

Color	CCT (K)	Part Number	Typical Luminous Flux ϕ_v (lm), $T_{case}=60^{\circ}C$	Typical Luminous Flux ϕ_v (lm), $T_j=25^{\circ}C$	Typical Forward Voltage V_f (V)	Forward Current (mA) ^[2]
Warm White	2700K	BXRA-W3500-00S0E	2325	2575	23.7	1400
			2750	3050	24.1	1750
			3300	3700	24.6	2100 ^[1]
	2700K	BXRA-W3500-00S0G	2075	2300	23.7	1400
			2550	2825	24.1	1750
			3000	3300	24.6	2100 ^[1]
	3000K	BXRA-W3500-00Q0E	2525	2800	23.7	1400
			3100	3425	24.1	1750
			3600	4000	24.6	2100 ^[1]
	3000K	BXRA-W3500-00Q0G	2275	2525	23.7	1400
			2775	3075	24.1	1750
			3250	3600	24.6	2100 ^[1]
	2700K	BXRA-W5700-00S0E	3450	3825	29.6	1750
			4050	4500	30.1	2100
			5200	5800	30.9	2800 ^[1]
	2700K	BXRA-W5700-00S0G	3100	3450	29.6	1750
			3650	4050	30.1	2100
			4700	5200	30.9	2800 ^[1]
	3000K	BXRA-W5700-00Q0E	3725	4150	29.6	1750
			4400	4900	30.1	2100
			5700	6300	30.9	2800 ^[1]
	3000K	BXRA-W5700-00Q0G	3375	3750	29.6	1750
			4000	4400	30.1	2100
			5100	5675	30.9	2800 ^[1]

Notes for Table 6, 7 and 8:

1. Product is tested and binned at the specified drive current.
2. Operating these LED Arrays at or below the drive currents listed in Table 6, with a case temperature maintained at or below 70°C, will enable the average lumen maintenance projection outlined earlier in this Product Data Sheet.

Typical Performance at Alternative Drive Currents (continued)

Table 7: Typical Product Performance at Alternative Drive Currents

Color	CCT (K)	Part Number	Typical Luminous Flux ϕ_v (lm), $T_{case}=60^{\circ}C$	Typical Luminous Flux ϕ_v (lm), $T_j=25^{\circ}C$	Typical Forward Voltage V_f (V)	Forward Current (mA) ^[2]
Neutral White	4000K	BXRA-N4000-00L0E	2775	3075	23.7	1400
			3375	3750	24.1	1750
			4000	4400	24.6	2100 ^[1]
	4000K	BXRA-N6300-00L0E	4150	4625	29.6	1750
			4900	5450	30.1	2100
			6300	7000	30.9	2800 ^[1]

Table 8: Typical Product Performance at Alternative Drive Currents

Color	Color	Part Number	Typical Luminous Flux ϕ_v (lm), $T_{case}=60^{\circ}C$	Typical Luminous Flux ϕ_v (lm), $T_j=25^{\circ}C$	Typical Forward Voltage V_f (V)	Forward Current (mA) ^[2]
Cool White	5600K	BXRA-C5000-00E0C	3525	3925	23.7	1400
			4325	4800	24.1	1750
			5100	5600	24.6	2100 ^[1]
	5600K	BXRA-C8000-00E0C	5225	5800	29.6	1750
			6175	6850	30.1	2100
			7900	8800	30.9	2800 ^[1]

Notes for Table 6, 7 and 8:

3. Product is tested and binned at the specified drive current.
4. Operating these LED Arrays at or below the drive currents listed in Table 6, with a case temperature maintained at or below 70°C, will enable the average lumen maintenance projection outlined earlier in this Product Data Sheet.

Mechanical Dimensions

Figure 1: Drawing for all RS Array part numbers.

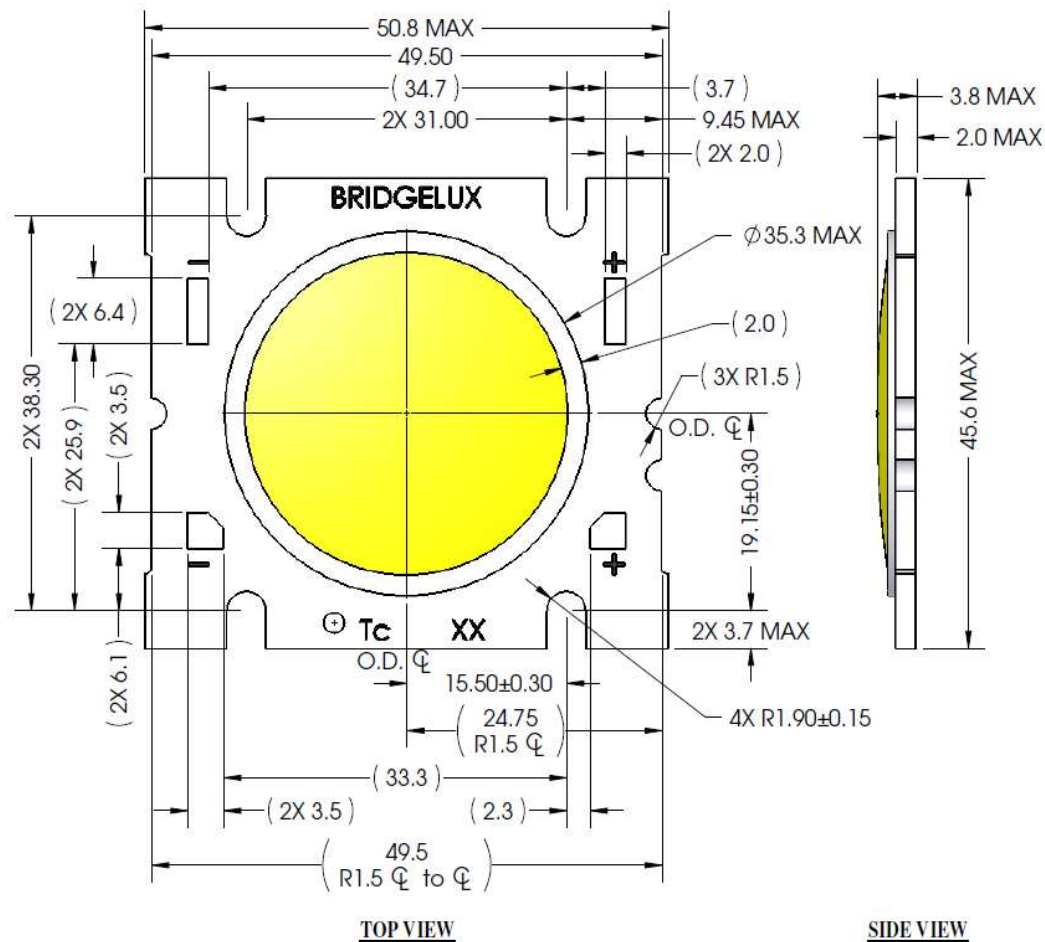

Notes for Figure 1:

1. Slots are for M2.5, M3 or #4 screws.
2. Solder pads are labeled "+" and "-" to denote positive and negative, respectively.
3. It is not necessary to provide electrical connections to both sets of solder pads. Either set of solder pads (6.35 x 2.03 mm rectangular pads or 3.50 mm tapered square pads) may be used depending on application specific design requirements.
4. Drawings are not to scale.
5. Drawing dimensions are in millimeters.
6. Bridgelux recommends four tapped holes for mounting screws – refer to figure 15 (Mechanical Assembly and Handling) for recommended spacing of holes.
7. Unless otherwise specified, tolerances are $\pm 0.10\text{mm}$.
8. Dimensions with parenthesis '()' are for reference only.
9. Refer to product Application Notes AN10 and AN11 for product handling, mounting and heat sink recommendations.
10. The optical center of the LED Array is defined by the mechanical center of the array.

Typical Radiation Pattern

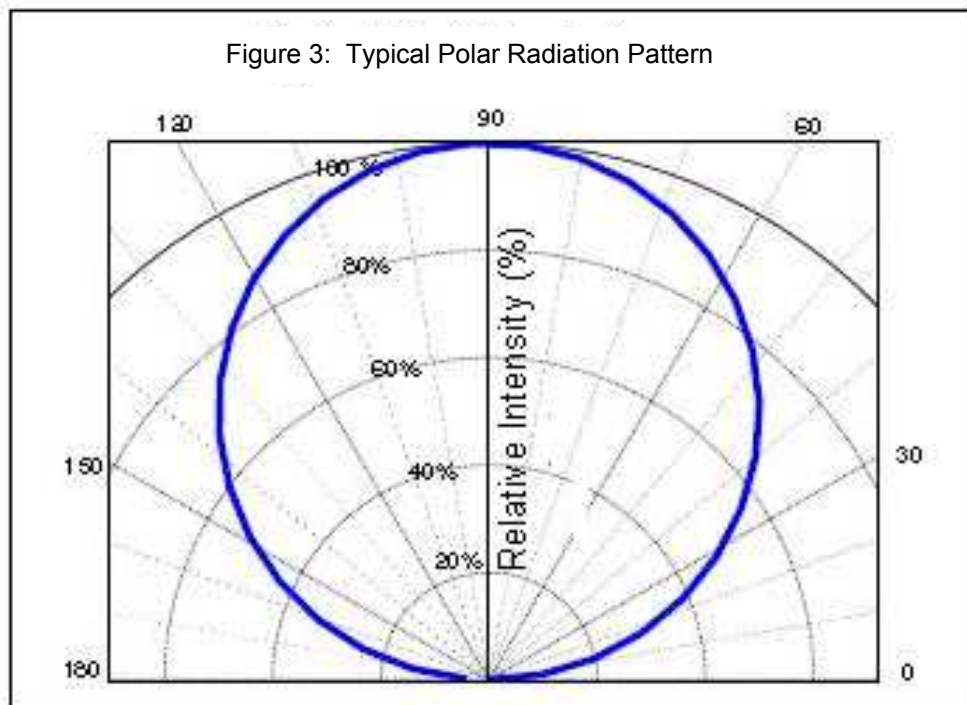
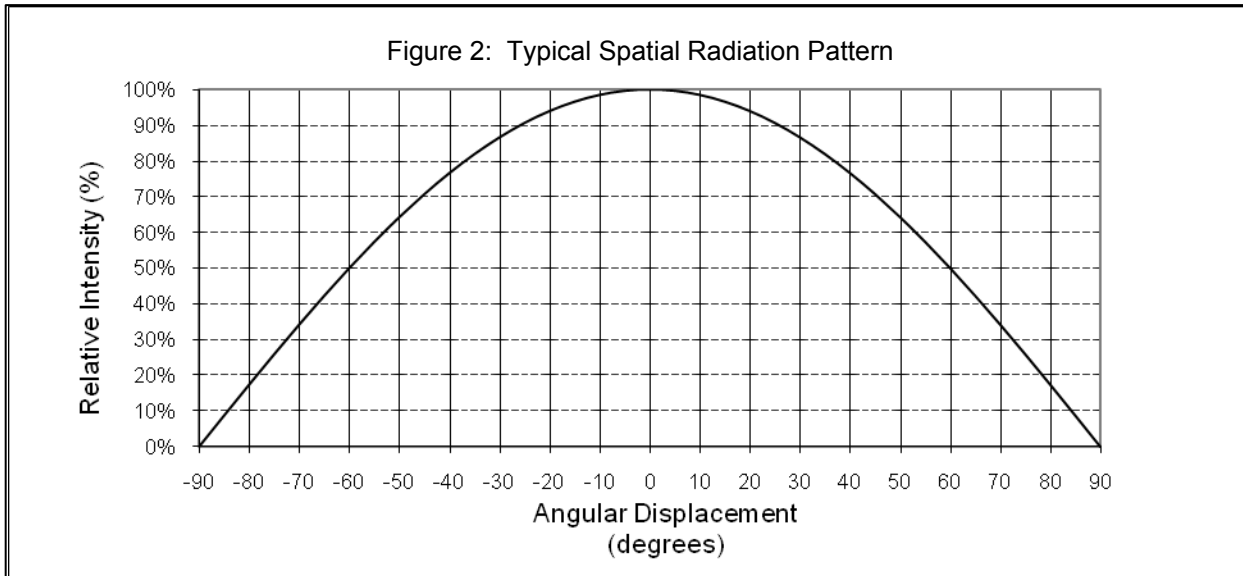

Wavelength Characteristics at Rated Test Current, $T_j=25^\circ\text{C}$

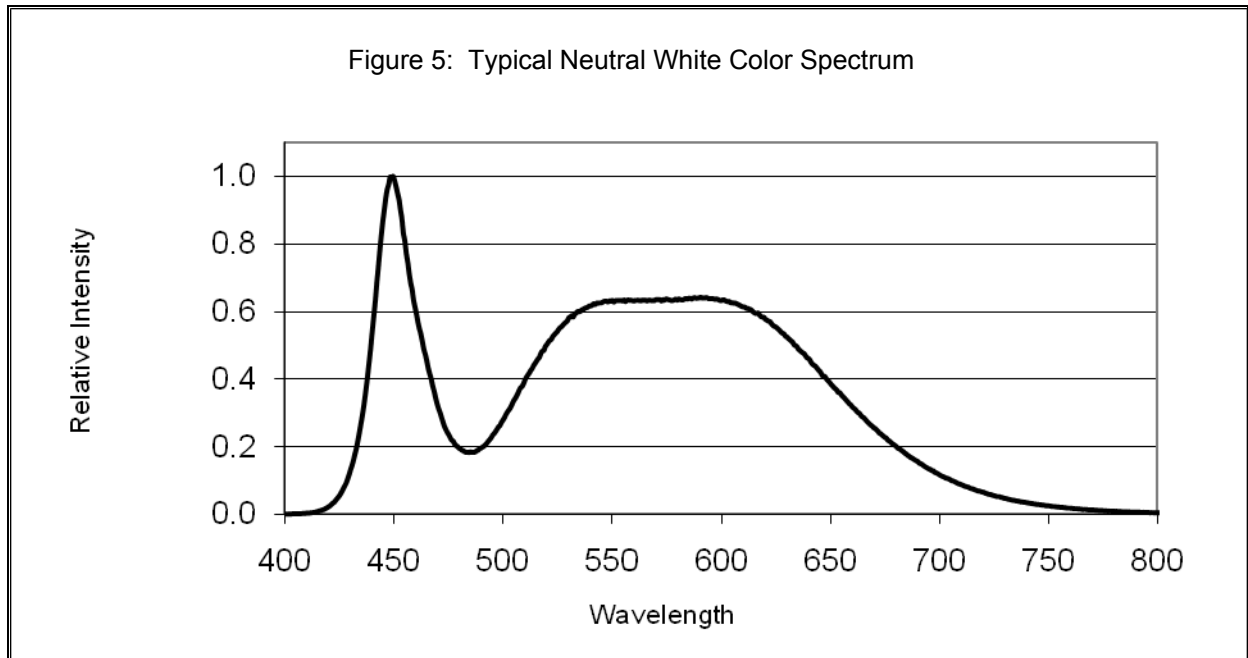
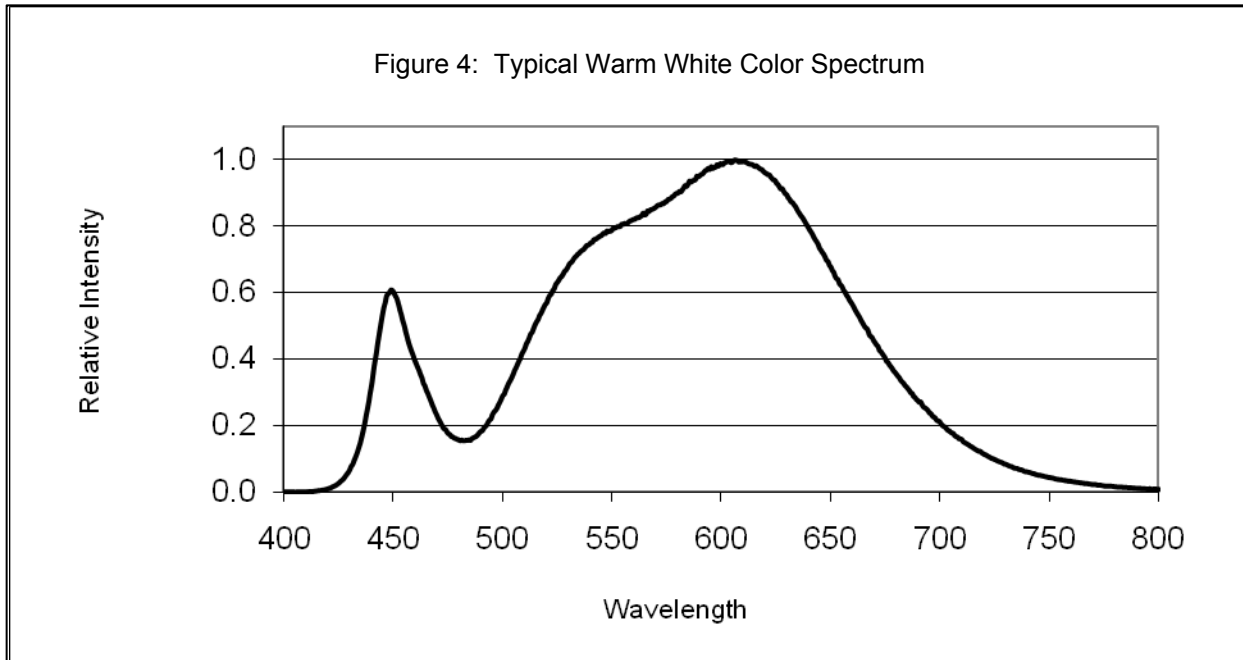

Wavelength Characteristics at Rated Test Current, $T_j=25^\circ\text{C}$ (Continued)

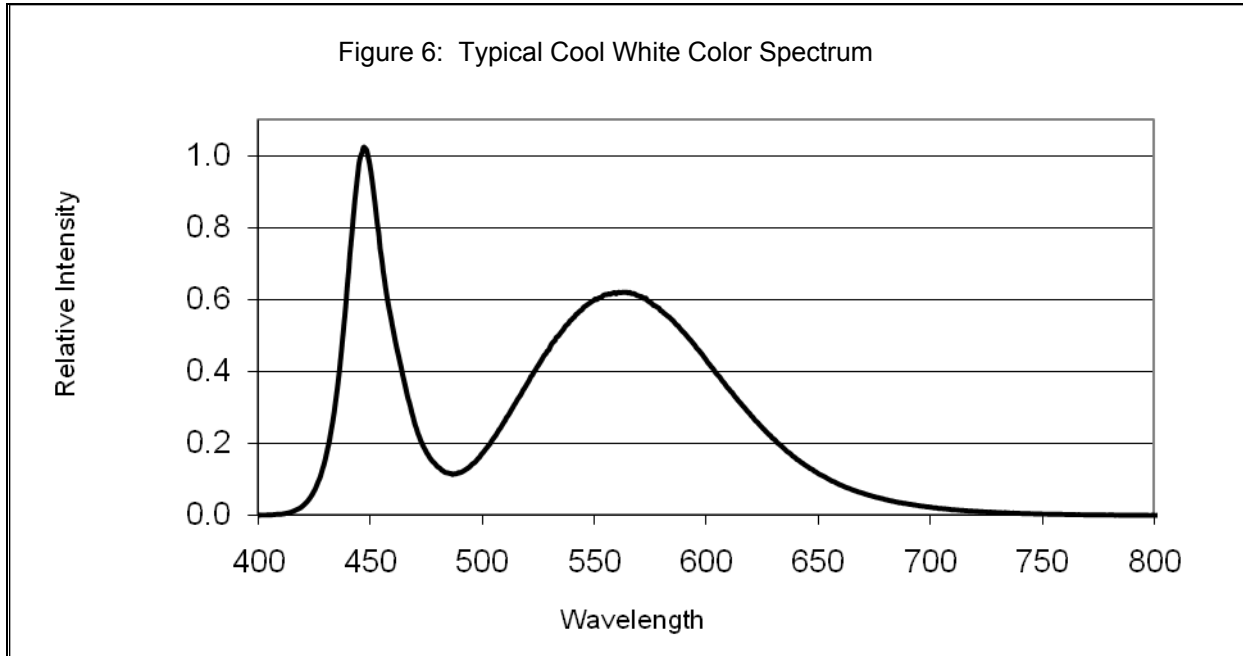

Typical Relative Luminous Flux vs. Current, T_j=25° C

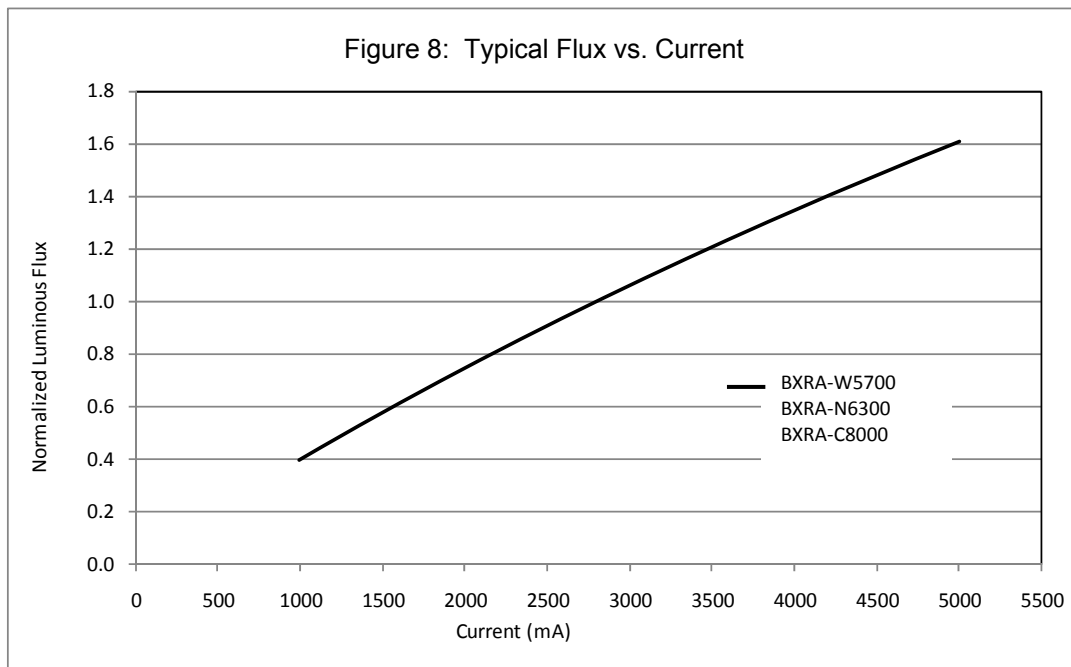
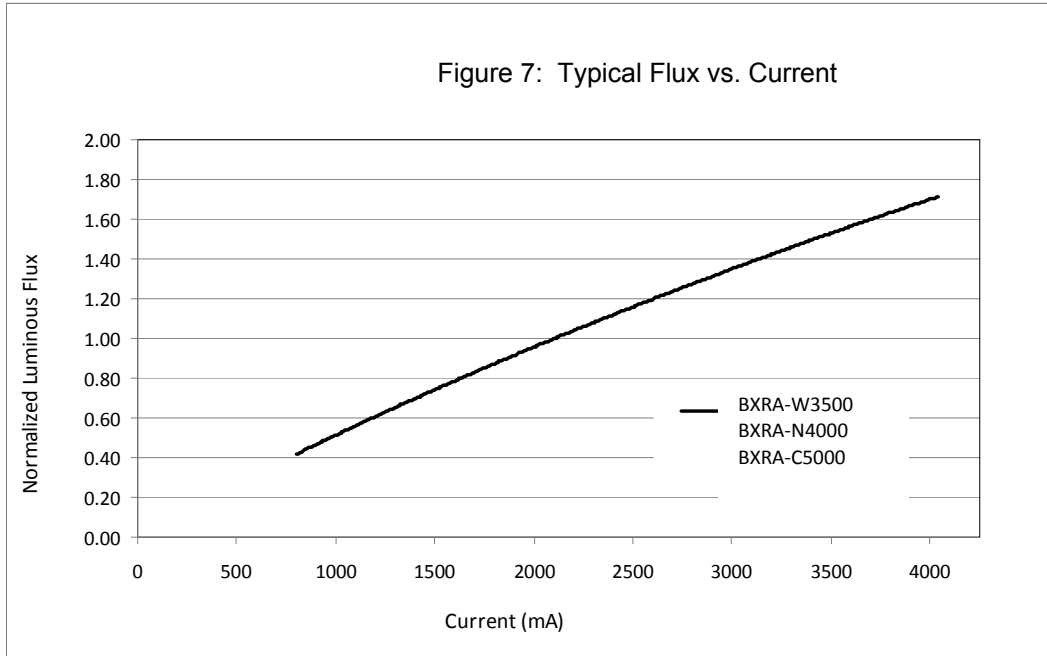

Note for Figure 7 and 8: Bridgelux does not recommend driving high power LED Arrays at low currents. Doing so may produce unpredictable results. Pulse width modulation (PWM) is recommended for dimming effects.

Typical Light Output Characteristics vs. Temperature

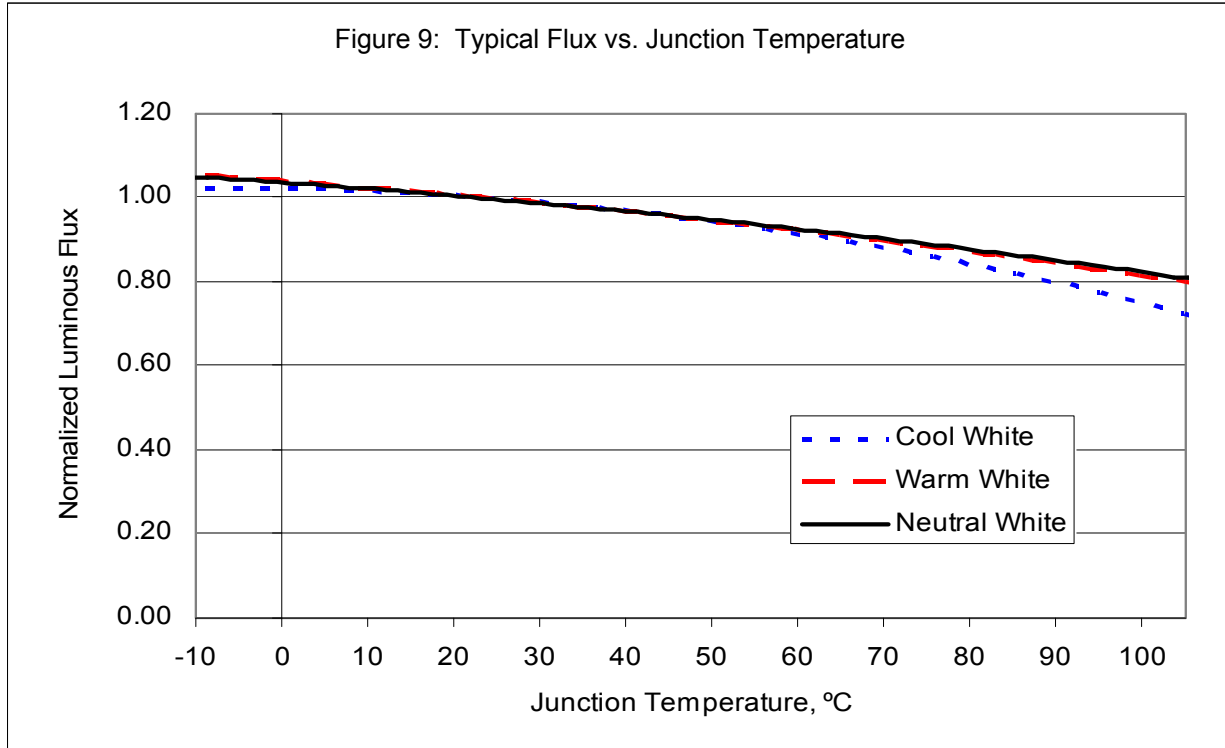

Typical Chromaticity Characteristics vs. Temperature

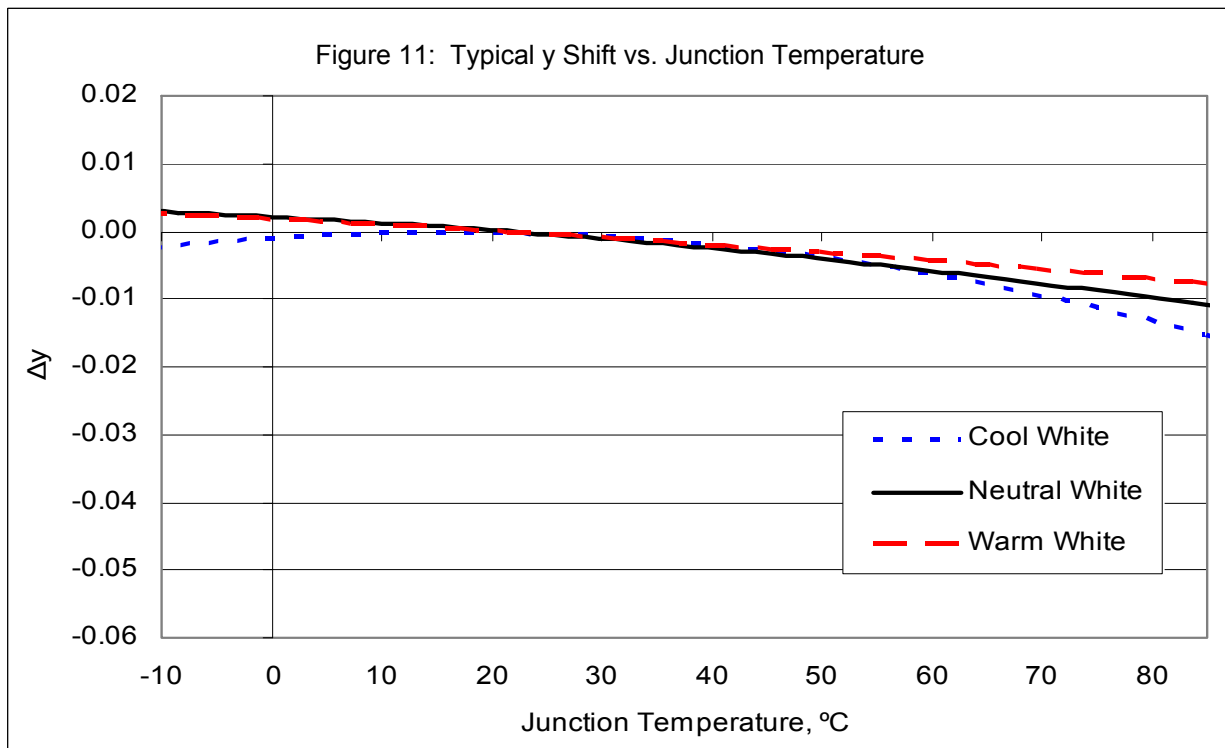
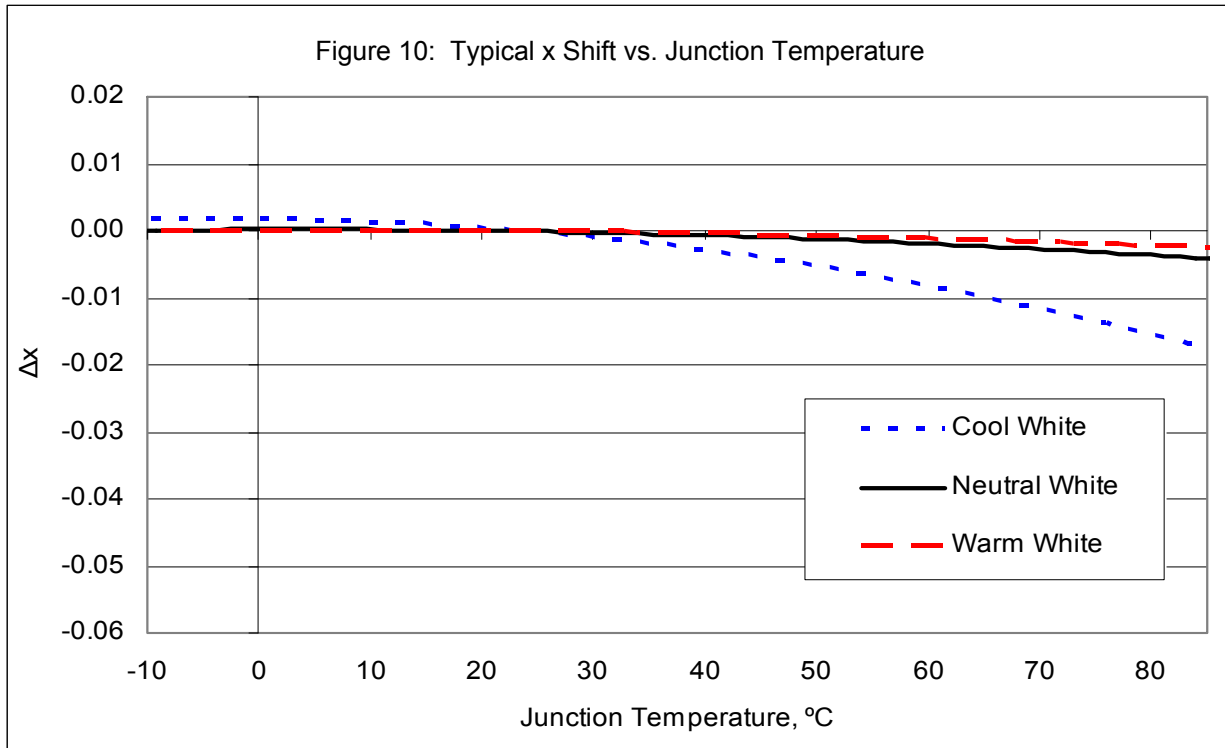

Forward Current Characteristics

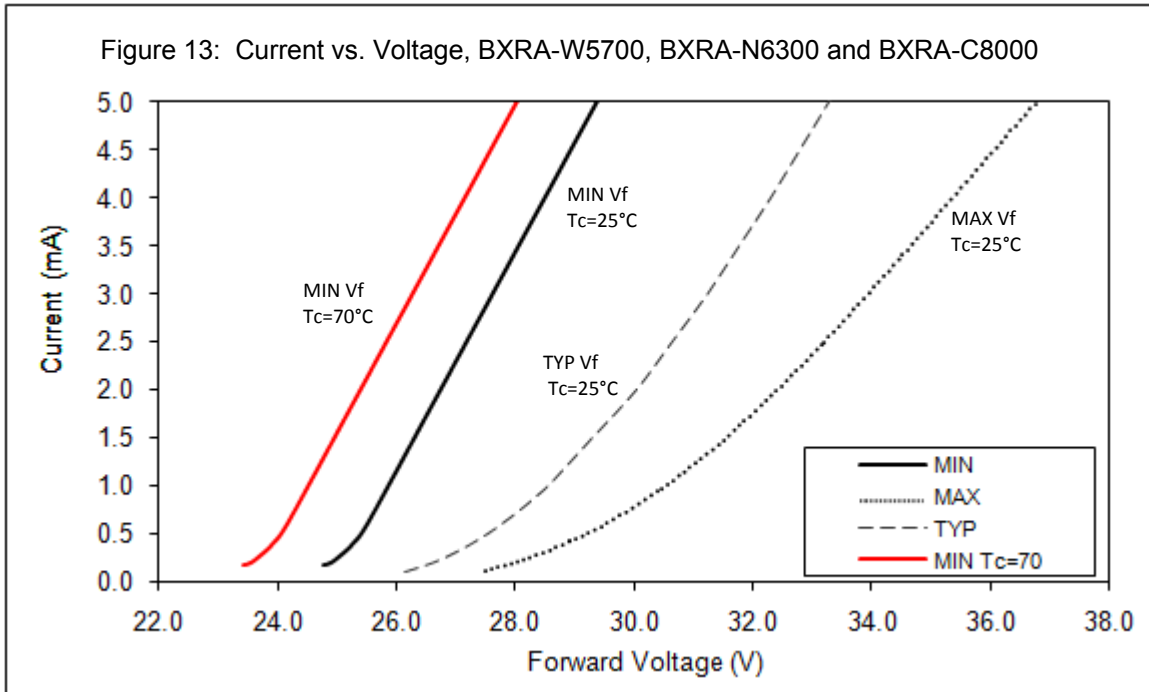
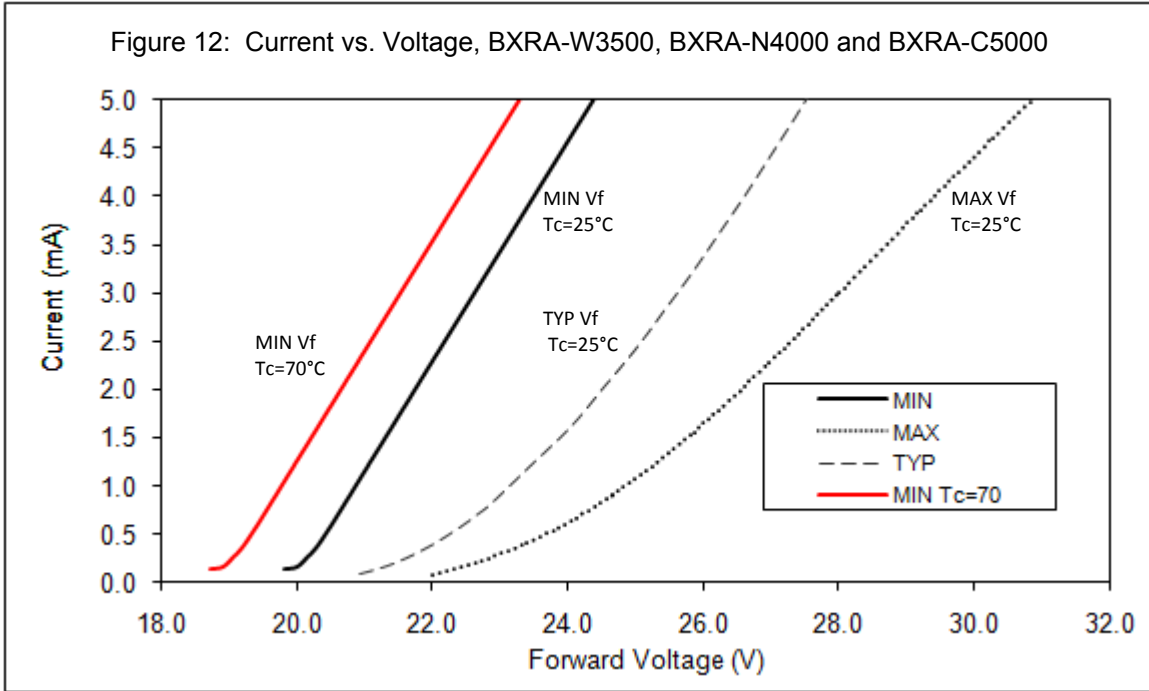

Current Derating Curves

The graph below illustrates the relationship between the system thermal resistance, drive current, and ambient temperature. Please note that absolute maximum ratings requirements, including that of maximum case temperature, must be adhered to in the system design. The thermal resistance values indicated in Figure 14 and 15 are total system values (junction to ambient) including the thermal resistance of the LED Array. Individual LED Array thermal resistance values are listed in Table 3.

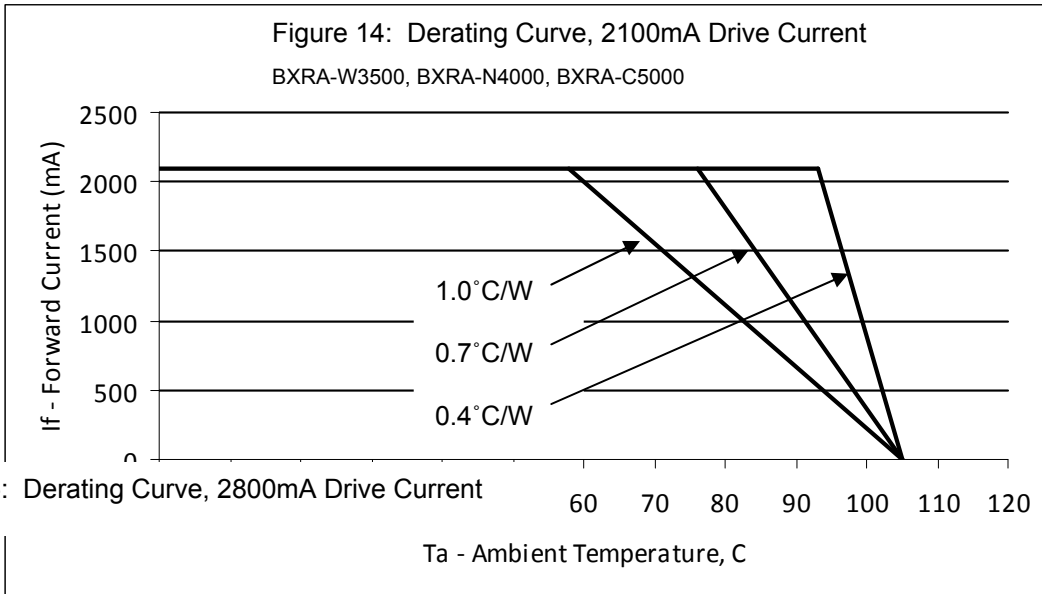
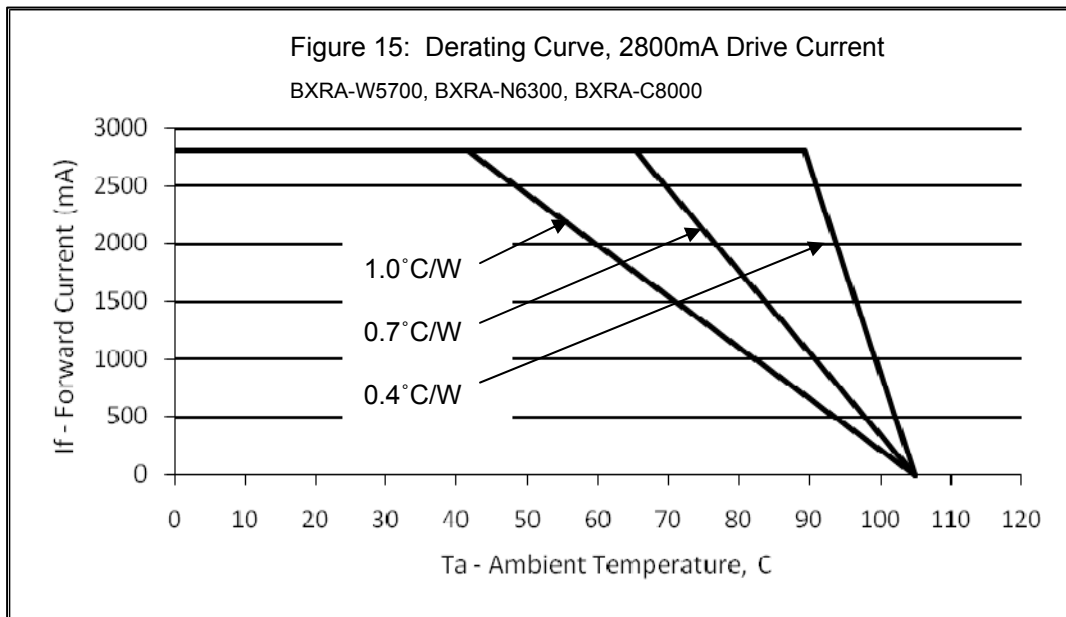

Figure 15: Derating Curve, 2800mA Drive Current



Product Binning

Typical manufacturing processes of semiconductor products result in a variation in performance surrounding the typical data sheet values. In order to minimize variation in the end product or application, Bridgelux bins its LED Arrays for color.

Bridgelux LED Arrays are labeled using a 3-digit alphanumeric bin code. This bin code is printed on the back of each LED Array in the following format:

B C D

Where:

B C – designates color bin (P3, P4, Q3, etc.)

D – designates color rendering index (0, A, B, C, etc)

All product packaged within a single tube are of the same color bin combination (or bin code). Using these codes it is possible to determine the best product utilization to deliver the consistency required in a given application.

Color Binning Information

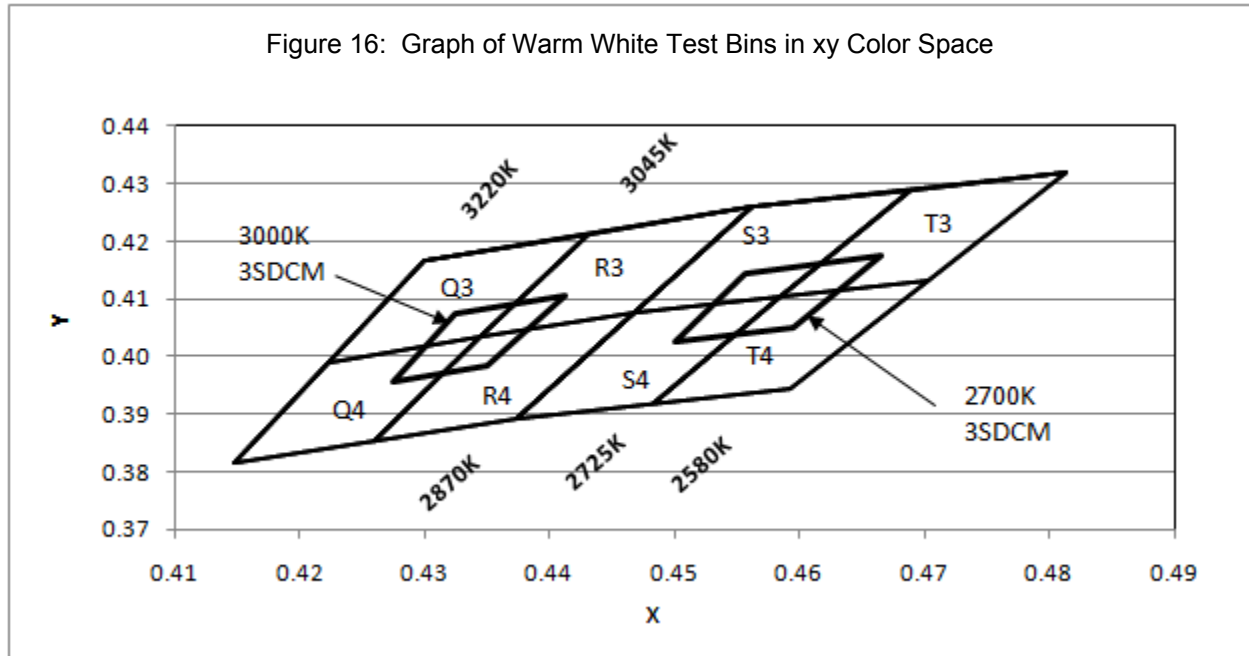

Table 9: Warm White xy Bin Coordinates and Associated Typical CCT

Bin Code	X	Y	ANSI CCT (K)
Q3	0.4223	0.3990	3000
	0.4299	0.4165	
	0.4431	0.4213	
	0.4345	0.4033	
Q4	0.4147	0.3814	3000
	0.4223	0.3990	
	0.4345	0.4033	
	0.4260	0.3854	
R3	0.4345	0.4033	3000
	0.4431	0.4213	
	0.4562	0.4260	
	0.4468	0.4077	
R4	0.4260	0.3854	3000
	0.4345	0.4033	
	0.4468	0.4077	
	0.4373	0.3893	
3SDCM	0.4413	0.4107	3000
	0.4325	0.4075	
	0.4274	0.3958	
	0.4350	0.3984	
S3	0.4468	0.4077	2700
	0.4562	0.4260	
	0.4688	0.4290	
	0.4585	0.4104	
S4	0.4373	0.3893	2700
	0.4468	0.4077	
	0.4585	0.4104	
	0.4483	0.3919	
T4	0.4585	0.4104	2700
	0.4688	0.4290	
	0.4813	0.4319	
	0.4703	0.4132	
T3	0.4483	0.3919	2700
	0.4585	0.4104	
	0.4703	0.4132	
	0.4593	0.3944	
3SDCM	0.4665	0.4175	2700
	0.4557	0.4145	
	0.4500	0.4026	
	0.4595	0.4050	

Color Binning Information (continued)

Figure 17: Graph of Neutral White Test Bins in xy Color Space

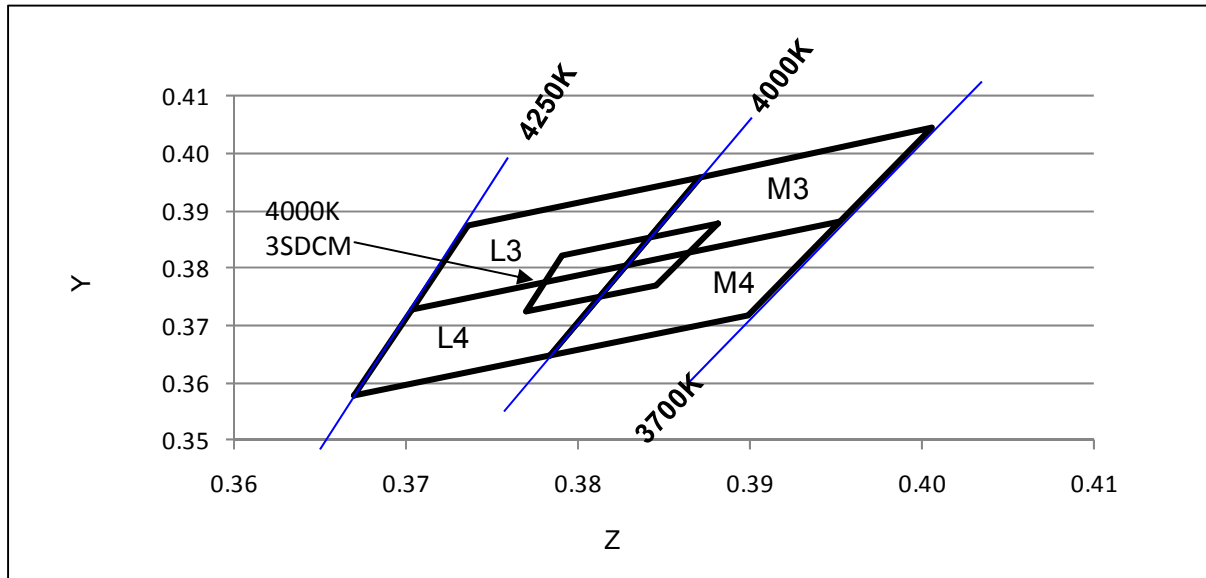

Table 10: Neutral White xy Bin Coordinates and Associated Typical CCT

Bin Code	X	Y	ANSI CCT (K)
L3	0.3703	0.3726	4000
	0.3736	0.3874	
	0.3871	0.3959	
	0.3828	0.3803	
L4	0.3670	0.3578	4000
	0.3703	0.3726	
	0.3828	0.3803	
	0.3784	0.3647	
M3	0.3828	0.3803	4000
	0.3871	0.3959	
	0.4006	0.4044	
	0.3952	0.3880	
M4	0.3784	0.3647	4000
	0.3828	0.3803	
	0.3952	0.3880	
	0.3898	0.3716	
3SDCM	0.3881	0.3879	4000
	0.3791	0.3823	
	0.3769	0.3724	
	0.3845	0.377	

Color Binning Information (continued)

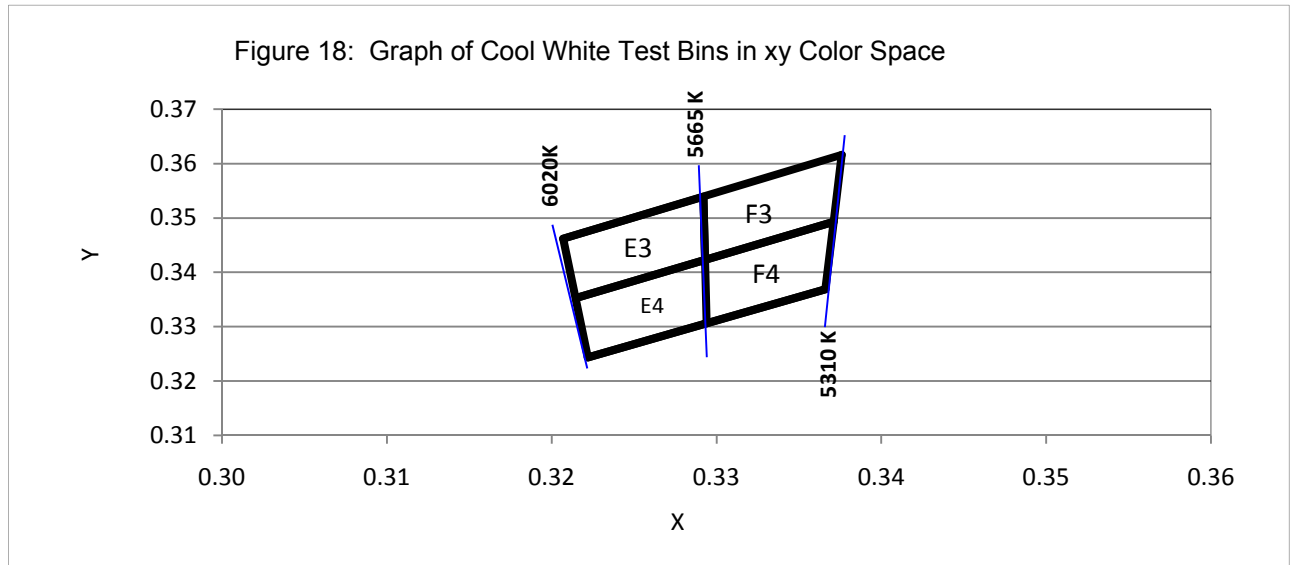

Table 11: Cool White xy Bin Coordinates and Associated Typical CCT

Bin Code	X	Y	ANSI CCT (K)
E4	0.3222	0.3243	5600
	0.3294	0.3306	
	0.3293	0.3423	
	0.3215	0.3353	
E3	0.3215	0.3353	5600
	0.3293	0.3423	
	0.3292	0.3539	
	0.3207	0.3462	
F3	0.3292	0.3539	5600
	0.3293	0.3423	
	0.3371	0.3493	
	0.3376	0.3616	
F4	0.3294	0.3306	5600
	0.3366	0.3369	
	0.3371	0.3493	
	0.3293	0.3423	

Mechanical Assembly and Handling

Recommended assembly is illustrated below.

When handling parts, please avoid contacting and do not apply stress to the resin area (see Figure 1, resin area is indicated in yellow).

Product should be firmly secured onto appropriate heat sink by fastening M2.5, M3 or #4 screws on both sides of the product as illustrated in Figure 19. To ensure proper thermal contact it is important to mount the LED Array to the heat sink using 4 mounting screws. Bridgelux recommends the use of hard non-electrically conductive flat washers with lock washers. The recommended center to center spacing for the four tapped holes for mounting the Bridgelux RS Series Array is shown in Figure 20. Refer to Application Note AN11 – Handling and Assembly of Bridgelux LED Arrays, for more details.

A thin layer of thermal grease should be applied to the bottom surface of the LED Array, between the bottom of the LED Array and the heat sink. All air gaps and voids between the heat sink and array should be eliminated. Ensure that sufficient thermal grease is used to cover the entire bottom surface of the array, but not so much that the thermal grease creeps up to the top of the array.

