



Chipsmall Limited consists of a professional team with an average of over 10 year of expertise in the distribution of electronic components. Based in Hongkong, we have already established firm and mutual-benefit business relationships with customers from,Europe,America and south Asia,supplying obsolete and hard-to-find components to meet their specific needs.

With the principle of “Quality Parts,Customers Priority,Honest Operation,and Considerate Service”,our business mainly focus on the distribution of electronic components. Line cards we deal with include Microchip,ALPS,ROHM,Xilinx,Pulse,ON,Everlight and Freescale. Main products comprise IC,Modules,Potentiometer,IC Socket,Relay,Connector.Our parts cover such applications as commercial,industrial, and automotives areas.

We are looking forward to setting up business relationship with you and hope to provide you with the best service and solution. Let us make a better world for our industry!



Contact us

Tel: +86-755-8981 8866 Fax: +86-755-8427 6832

Email & Skype: info@chipsmall.com Web: www.chipsmall.com

Address: A1208, Overseas Decoration Building, #122 Zhenhua RD., Futian, Shenzhen, China



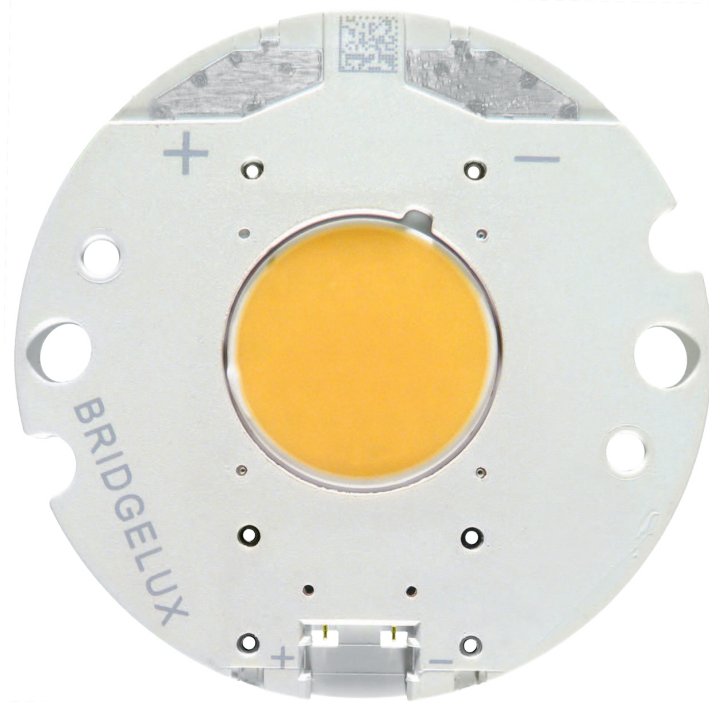

Bridgelux® Vero® 13 Array Series

Product Data Sheet DS31



BXRC-27X2000

30X2000

35X2000

40X2000

50X2000

Introduction

Vero



Vero represents a revolutionary advancement in chip on board (COB) light source technology and innovation. Vero LED light sources simplify luminaire design and manufacturing processes, improve light quality, and define a platform for future functionality integration.

Vero is available in four different light emitting surface (LES) configurations and has been engineered to reliably operate over a broad current range, enabling new degrees of flexibility in luminaire design optimization. Vero arrays deliver increased lumen density to enable improved beam control and precision lighting with 2 and 3 SDCM color control standard for clean and consistent uniform lighting.

Vero includes an on board connector port to enable solder free electrical interconnect and simple easy to use mounting features to enable plug-and-play installation.

Features

- Efficacy of 130 lm/W typical
- Vero 13 lumen output performance ranges from 600 to 4,301 lumens
- Broad range of CCT options from 2700K to 5000K
- CRI options include; minimum 70, 80, and 90
- 2 and 3 SDCM color control for 2700K-4000K CCT
- Reliable operation at up to 2X nominal drive current
- Radial die pattern and improved lumen density
- Thermally isolated solder pads
- Onboard connector port
- Top side part number markings

Benefits

- Broad application coverage for interior and exterior lighting
- Flexibility for application driven lighting design requirements
- High quality true color reproduction
- Uniform consistent white light
- Flexibility in design optimization
- Improved optical control
- Enhanced ease of use and manufacturability
- Solderless connectivity enables plug & play installation and field upgradability
- Improved inventory management and quality control

Contents

Product Feature Map	2
Product Nomenclature	2
Product Selection Guide	3
Performance at Commonly Used Drive Currents	4
Electrical Characteristics	6
Absolute Maximum Ratings	7
Performance Curves	8
Typical Radiation Pattern	11
Typical Color Spectrum	12
Mechanical Dimensions	13
Color Binning Information	14
Packaging	15
Design Resources	17
Precautions	17
Disclaimers	17
About Bridgelux	18

Product Feature Map

Vero 13 is the second smallest form factor in the Vero family of the next generation solid state light sources. In addition to delivering the performance and light quality required for many lighting applications, Vero incorporates

several features to simplify the design integration and manufacturing process, accelerate time to market and reduce system costs. Please visit www.bridgelux.com for more information on the Vero family of products.

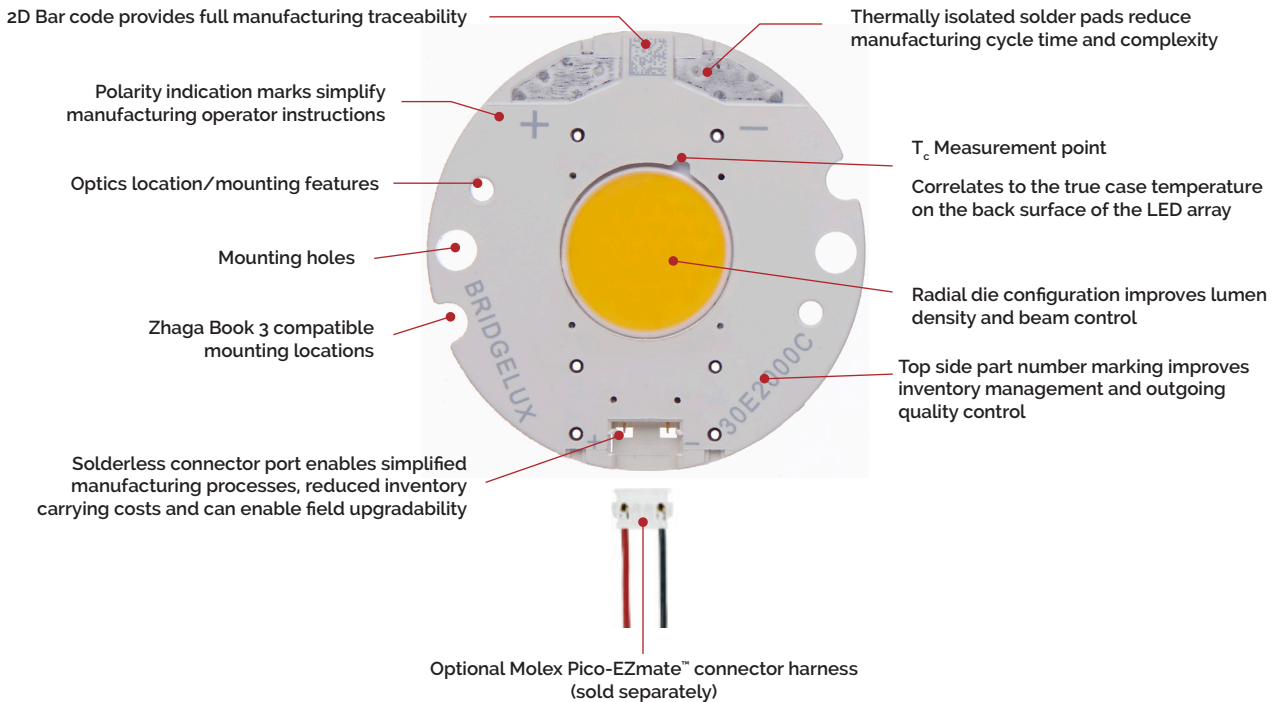

Product Nomenclature

The part number designation for Bridgelux Vero LED arrays is explained as follows:

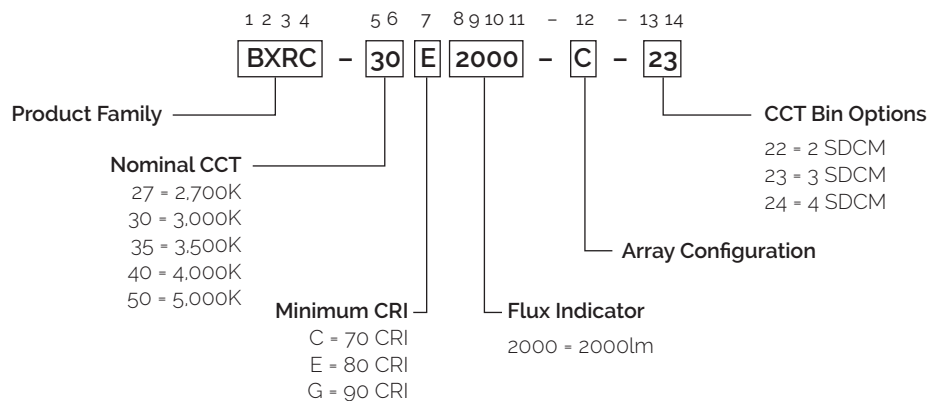

Product Selection Guide

The following product configurations are available:

Table 1: Selection Guide, Pulsed Measurement Data ($T_j = T_c = 25^\circ\text{C}$)

Part Number	Nominal CCT ¹ (K)	CRI ²	Nominal Drive Current ³ (mA)	Typical Pulsed Flux ^{4,5,6} $T_c = 25^\circ\text{C}$ (lm)	Minimum Pulsed Flux ^{6,7} $T_c = 25^\circ\text{C}$ (lm)	Typical V_f (V)	Typical Power (W)	Typical Efficacy (lm/W)
BXRC-27E2000-C-2X	2700	80	500	2039	1935	32.3	16.2	126
BXRC-27G2000-C-2X	2700	90	500	1696	1576	32.3	16.2	105
BXRC-30E2000-C-2X	3000	80	500	2133	1947	32.3	16.2	132
BXRC-30G2000-C-2X	3000	90	500	1785	1605	32.3	16.2	111
BXRC-35E2000-C-2X	3500	80	500	2187	2000	32.3	16.2	135
BXRC-35G2000-C-2X	3500	90	500	1868	1776	32.3	16.2	116
BXRC-40E2000-C-2X	4000	80	500	2262	2114	32.3	16.2	140
BXRC-40G2000-C-2X	4000	90	500	1928	1786	32.3	16.2	119
BXRC-50C2000-C-24	5000	70	500	2394	2245	32.3	16.2	148
BXRC-50E2000-C-24	5000	80	500	2252	2114	32.3	16.2	139
BXRC-50G2000-C-24	5000	90	500	2015	1809	32.3	16.2	125

Table 2: Selection Guide, Stabilized DC Performance ($T_c = 85^\circ\text{C}$)^{8,9}

Part Number	Nominal CCT ¹ (K)	CRI ²	Nominal Drive Current ³ (mA)	Typical DC Flux $T_c = 85^\circ\text{C}$ (lm)	Minimum DC Flux ¹⁰ $T_c = 85^\circ\text{C}$ (lm)	Typical V_f (V)	Typical Power (W)	Typical Efficacy (lm/W)
BXRC-27E2000-C-2X	2700	80	500	1867	1772	31.3	15.6	119
BXRC-27G2000-C-2X	2700	90	500	1492	1387	31.3	15.6	95
BXRC-30E2000-C-2X	3000	80	500	1921	1754	31.3	15.6	123
BXRC-30G2000-C-2X	3000	90	500	1571	1412	31.3	15.6	100
BXRC-35E2000-C-2X	3500	80	500	1981	1811	31.3	15.6	127
BXRC-35G2000-C-2X	3500	90	500	1644	1563	31.3	15.6	105
BXRC-40E2000-C-2X	4000	80	500	2040	1907	31.3	15.6	130
BXRC-40G2000-C-2X	4000	90	500	1697	1572	31.3	15.6	108
BXRC-50C2000-C-24	5000	70	500	2107	1976	31.3	15.6	135
BXRC-50E2000-C-24	5000	80	500	1982	1860	31.3	15.6	127
BXRC-50G2000-C-24	5000	90	500	1773	1592	31.3	15.6	113

Notes for Tables 1 & 2:

- Nominal CCT as defined by ANSI C78.377-2011.
- CRI Values are minimums. Minimum Rg value for 80 CRI products is 0, the minimum Rg values for 90 CRI products is 50.
- Drive current is referred to as nominal drive current.
- Products tested under pulsed condition (10ms pulse width) at nominal test current where T_j (junction temperature) = T_c (case temperature) = 25°C .
- Typical performance values are provided as a reference only and are not a guarantee of performance.
- Bridgelux maintains a $\pm 7\%$ tolerance on flux measurements.
- Minimum flux values at the nominal test current are guaranteed by 100% test.
- Typical stabilized DC performance values are provided as reference only and are not a guarantee of performance.
- Typical performance is estimated based on operation under DC (direct current) with LED array mounted onto a heat sink with thermal interface material and the case temperature maintained at 85°C . Based on Bridgelux test setup, values may vary depending on the thermal design of the luminaire and/or the exposed environment to which the product is subjected.
- Minimum flux values at elevated temperatures are provided for reference only and are not guaranteed by 100% production testing. Based on Bridgelux test setup, values may vary depending on the thermal design of the luminaire and/or the exposed environment to which the product is subjected.

Performance at Commonly Used Drive Currents

Vero LED arrays are tested to the specifications shown using the nominal drive currents in Table 1. Vero may also be driven at other drive currents dependent on specific application design requirements. The performance at any drive current can be derived from the current vs. voltage characteristics shown in Figure 1 and the flux vs. current characteristics shown in Figure 2. The performance at commonly used drive currents is summarized in Table 3.

Table 3: Product Performance at Commonly Used Drive Currents

Part Number	CRI	Drive Current ¹ (mA)	Typical V_f $T_c = 25^\circ\text{C}$ (V)	Typical Power $T_c = 25^\circ\text{C}$ (W)	Typical Flux ² $T_c = 25^\circ\text{C}$ (lm)	Typical DC Flux ³ $T_c = 85^\circ\text{C}$ (lm)	Typical Efficacy $T_c = 25^\circ\text{C}$ (lm/W)
BXRC-27E2000-C-2x	80	175	30.2	5.3	781	715	148
		350	31.4	11.0	1488	1361	135
		500	32.3	16.2	2039	1867	126
		700	33.4	23.4	2705	2484	116
		1050	35.1	36.9	3663	3382	99
BXRC-27G2000-C-2x	90	175	30.2	5.3	650	572	123
		350	31.4	11.0	1237	1088	113
		500	32.3	16.2	1696	1492	105
		700	33.4	23.4	2250	1985	96
		1050	35.1	36.9	3047	2703	83
BXRC-30E2000-C-2x	80	175	30.2	5.3	817	736	155
		350	31.4	11.0	1556	1400	142
		500	32.3	16.2	2133	1921	132
		700	33.4	23.4	2830	2556	121
		1050	35.1	36.9	3832	3480	104
BXRC-30G2000-C-2x	90	175	30.2	5.3	684	602	129
		350	31.4	11.0	1302	1145	119
		500	32.3	16.2	1785	1571	111
		700	33.4	23.4	2368	2090	101
		1050	35.1	36.9	3207	2845	87
BXRC-35E2000-C-2x	80	175	30.2	5.3	838	759	159
		350	31.4	11.0	1596	1444	145
		500	32.3	16.2	2187	1981	135
		700	33.4	23.4	2902	2635	124
		1050	35.1	36.9	3929	3587	107
BXRC-35G2000-C-2x	90	175	30.2	5.3	716	630	135
		350	31.4	11.0	1363	1198	124
		500	32.3	16.2	1868	1644	116
		700	33.4	23.4	2479	2187	106
		1050	35.1	36.9	3356	2977	91

Notes for Table 3:

1. Alternate drive currents in Table 3 are provided for reference only and are not a guarantee of performance.
2. Bridgelux maintains a $\pm 7\%$ tolerance on flux measurements.
3. Typical stabilized DC performance values are provided as reference only and are not a guarantee of performance.

Performance at Commonly Used Drive Currents

Table 3: Product Performance at Commonly Used Drive Currents (Continued)

Part Number	CRI	Drive Current ¹ (mA)	Typical V_f $T_c = 25^\circ\text{C}$ (V)	Typical Power $T_c = 25^\circ\text{C}$ (W)	Typical Flux ² $T_c = 25^\circ\text{C}$ (lm)	Typical DC Flux ³ $T_c = 85^\circ\text{C}$ (lm)	Typical Efficacy $T_c = 25^\circ\text{C}$ (lm/W)
BXRC-40E2000-C-2x	80	175	30.2	5.3	867	781	164
		350	31.4	11.0	1650	1487	150
		500	32.3	16.2	2262	2040	140
		700	33.4	23.4	3001	2714	128
		1050	35.1	36.9	4064	3695	110
BXRC-40G2000-C-2x	90	175	30.2	5.3	739	650	140
		350	31.4	11.0	1407	1237	128
		500	32.3	16.2	1928	1697	119
		700	33.4	23.4	2558	2257	109
		1050	35.1	36.9	3464	3073	94
BXRC-50C2000-C-24	70	175	30.2	5.3	917	807	174
		350	31.4	11.0	1747	1536	159
		500	32.3	16.2	2394	2107	148
		700	33.4	23.4	3176	2803	136
		1050	35.1	36.9	4301	3816	117
BXRC-50E2000-C-24	80	175	30.2	5.3	863	759	163
		350	31.4	11.0	1643	1444	150
		500	32.3	16.2	2252	1982	139
		700	33.4	23.4	2988	2636	128
		1050	35.1	36.9	4046	3589	110
BXRC-50G2000-C-24	90	175	30.2	5.3	772	679	146
		350	31.4	11.0	1470	1292	134
		500	32.3	16.2	2015	1773	125
		700	33.4	23.4	2674	2359	114
		1050	35.1	36.9	3620	3212	98

Notes for Table 3:

1. Alternate drive currents in Table 3 are provided for reference only and are not a guarantee of performance.
2. Bridgelux maintains a $\pm 7\%$ tolerance on flux measurements.
3. Typical stabilized DC performance values are provided as reference only and are not a guarantee of performance.

Electrical Characteristics

Table 4: Electrical Characteristics

Part Number	Drive Current (mA)	Forward Voltage Pulsed, $T_c = 25^\circ\text{C}$ (V) ^{1, 2, 3}			Typical Coefficient of Forward Voltage ⁴ $\Delta V_f / \Delta T_c$ (mV/ $^\circ\text{C}$)	Typical Thermal Resistance Junction to Case ^{5,6} R_{j-c} ($^\circ\text{C}/\text{W}$)	Driver Selection Voltages ⁷ (V)	
		Minimum	Typical	Maximum			V_f Min. Hot $T_c = 105^\circ\text{C}$ (V)	V_f Max. Cold $T_c = -40^\circ\text{C}$ (V)
BXRC-xxx2000-C-2x	500	29.9	32.3	34.7	-17	0.22	28.5	35.8
	1050	32.0	35.1	37.9	-17	0.28	30.6	39.0

Notes for Table 4:

- Parts are tested in pulsed conditions, $T_c = 25^\circ\text{C}$. Pulse width is 10ms.
- Voltage minimum and maximum are provided for reference only and are not a guarantee of performance.
- Bridgelux maintains a tester tolerance of $\pm 0.10\text{V}$ on forward voltage measurements.
- Typical coefficient of forward voltage tolerance is $\pm 0.1\text{mV}$ for nominal current.
- Thermal resistance values are based from test data of a 3000K 80 CRI product.
- Thermal resistance value was calculated using total electrical input power; optical power was not subtracted from input power. The thermal interface material used during testing is not included in the thermal resistance value.
- V_f min hot and max cold values are provided as reference only and are not guaranteed by test. These values are provided to aid in driver design and selection over the operating range of the product.

Absolute Maximum Ratings

Table 5: Maximum Ratings

Parameter	Maximum Rating
LED Junction Temperature (T_j)	150°C
Storage Temperature	-40°C to +105°C
Operating Case Temperature ¹ (T_c)	105°C
Soldering Temperature ²	350°C or lower for a maximum of 10 seconds
Maximum Drive Current ^{3,4,5}	1050mA
Maximum Peak Pulsed Drive Current ⁶	1500mA
Maximum Reverse Voltage ⁷	-55V

Notes for Table 5:

1. For IEC 62717 requirement, please consult your Bridgelux sales representative.
2. Refer to Bridgelux Application Note AN31: Assembly Considerations for Bridgelux Vero LED Arrays.
3. DC Forward Current for LM-80 is the maximum drive current for which LM-80 data is currently available.
4. Lumen maintenance (L70) and lifetime predictions are valid for drive current and case temperature conditions used for LM-80 testing as included in the applicable LM-80 test report for these arrays. Contact your Bridgelux sales representatives for LM-80 report.
5. Arrays may be driven at higher currents however lumen maintenance may be reduced.
6. Bridgelux recommends a maximum duty cycle of 10% and pulse width of 20 ms when operating LED Arrays at maximum peak pulsed current specified. Maximum peak pulsed currents indicate values where LED Arrays can be driven without catastrophic failures.
7. Light emitting diodes are not designed to be driven in reverse voltage and will not produce light under this condition. Maximum rating provided for reference only.

Performance Curves

Figure 1: Drive Current vs. Voltage ($T_j = T_c = 25^\circ\text{C}$)

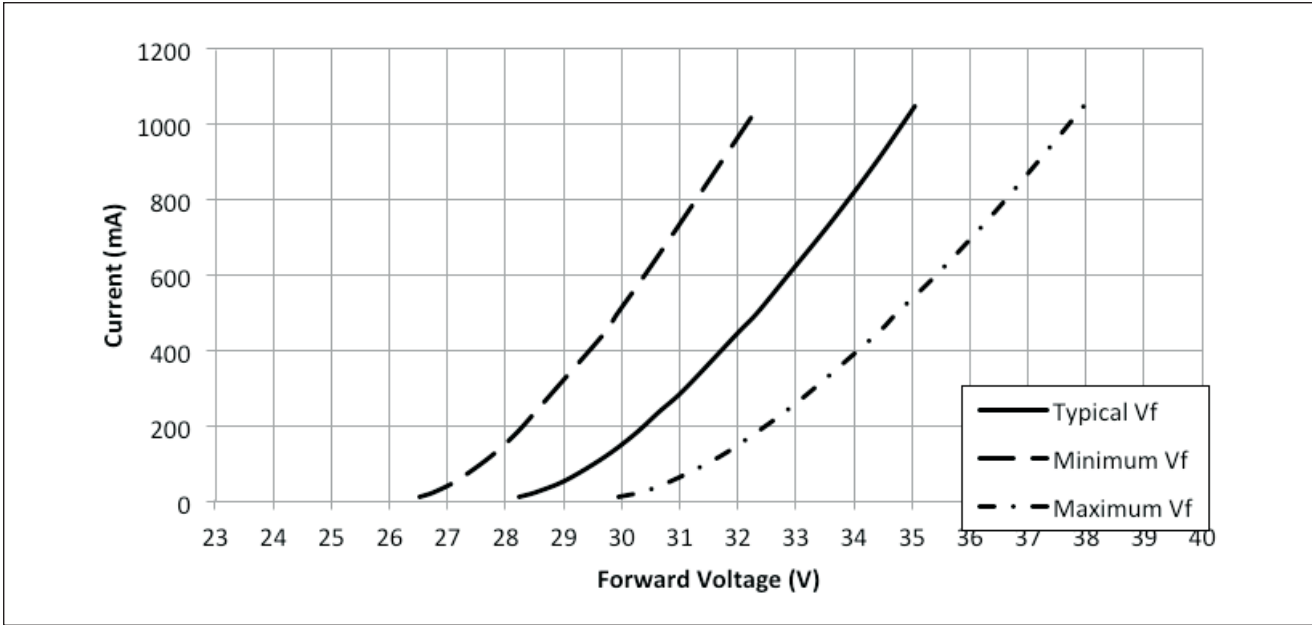
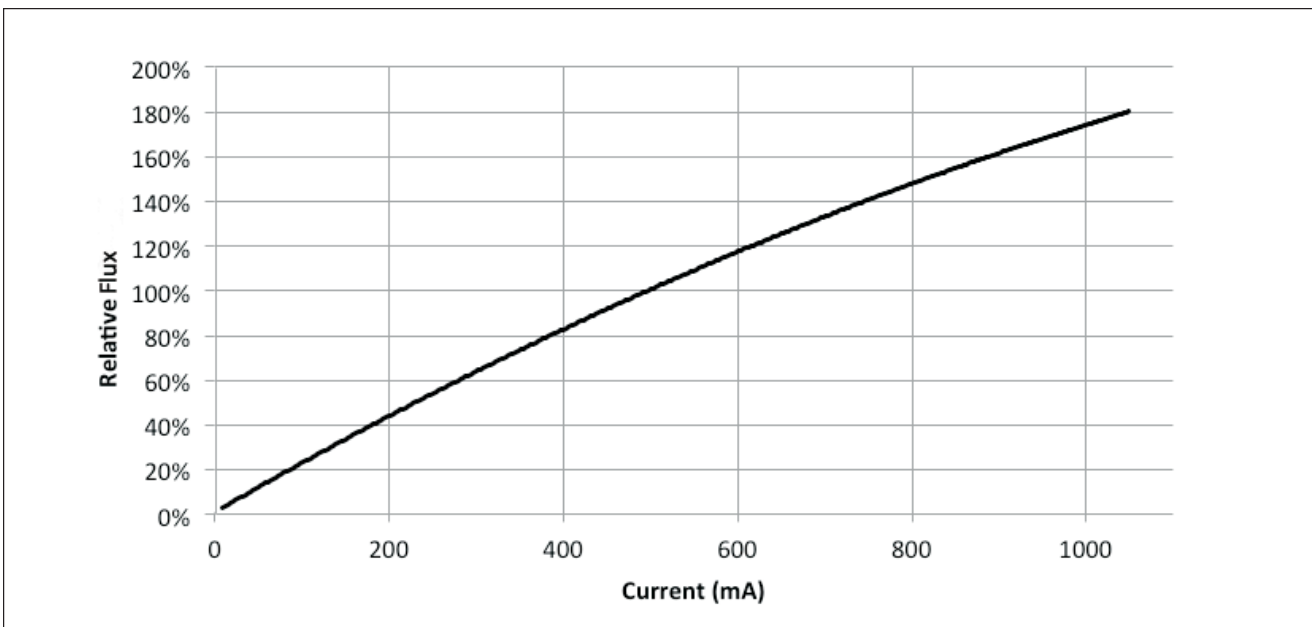

Figure 2: Typical Relative Luminous Flux vs. Current ($T_j = T_c = 25^\circ\text{C}$)



Note for Figure 2:

1. Bridgelux does not recommend driving high power LEDs at low currents. Doing so may produce unpredictable results. Pulse width modulation (PWM) is recommended for dimming effects.

Performance Curves

Figure 3: Typical DC Flux vs. Case Temperature

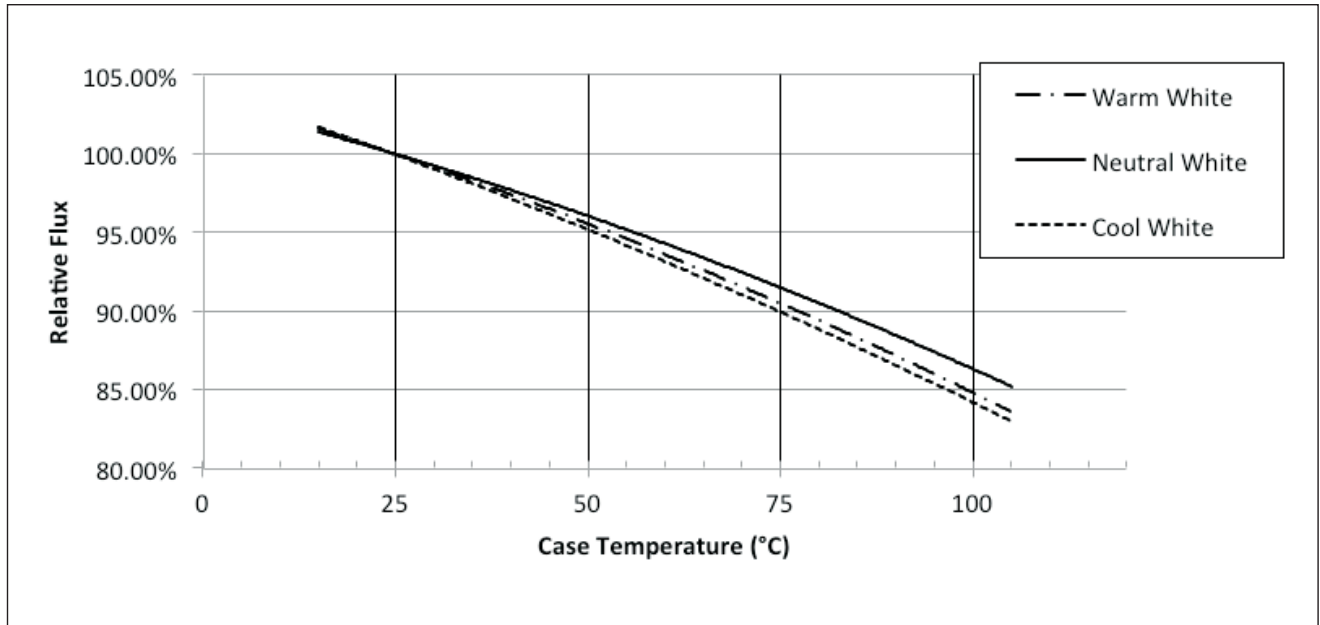
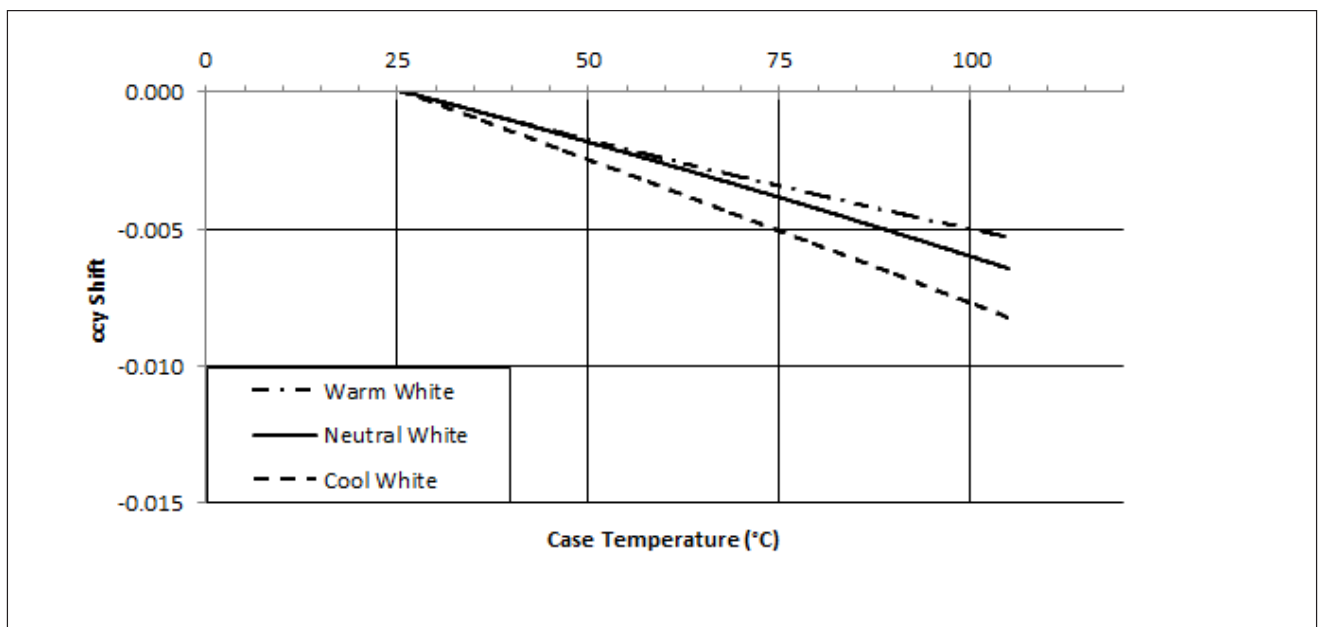

Figure 4: Typical DC ccy Shift vs. Case Temperature



Notes for Figures 3-4:

1. Characteristics shown for warm white based on 3000K and 80 CRI.
2. Characteristics shown for neutral white based on 4000K and 80 CRI.
3. Characteristics shown for cool white based on 5000K and 70 CRI.
4. For other color SKUs, the shift in color will vary. Please contact your Bridgelux Sales Representative for more information.

Performance Curves

Figure 5: Typical DC ccx Shift vs. Case Temperature

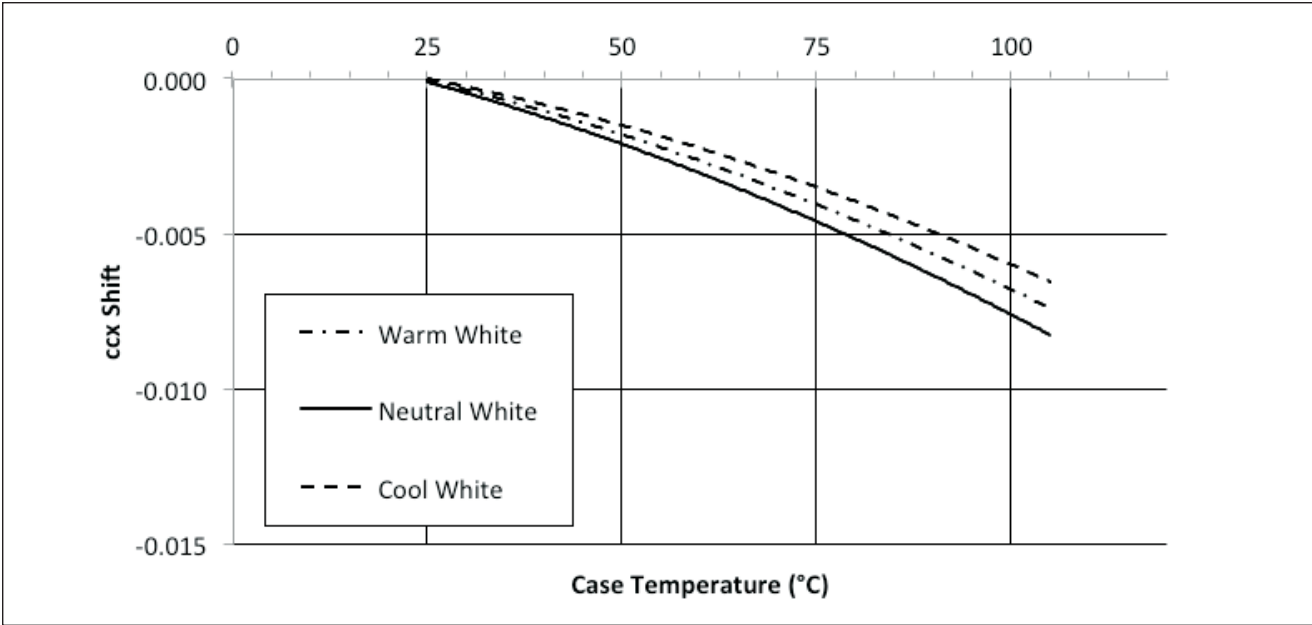

Notes for Figure 5:

- 1. Characteristics shown for warm white based on 3000K and 80 CRI.
- 2. Characteristics shown for neutral white based on 4000K and 80 CRI.
- 3. Characteristics shown for cool white based on 5000K and 70 CRI.
- 4. For other color SKUs, the shift in color will vary. Please contact your Bridgelux Sales Representative for more information.

Typical Radiation Pattern

Figure 6: Typical Spatial Radiation Pattern

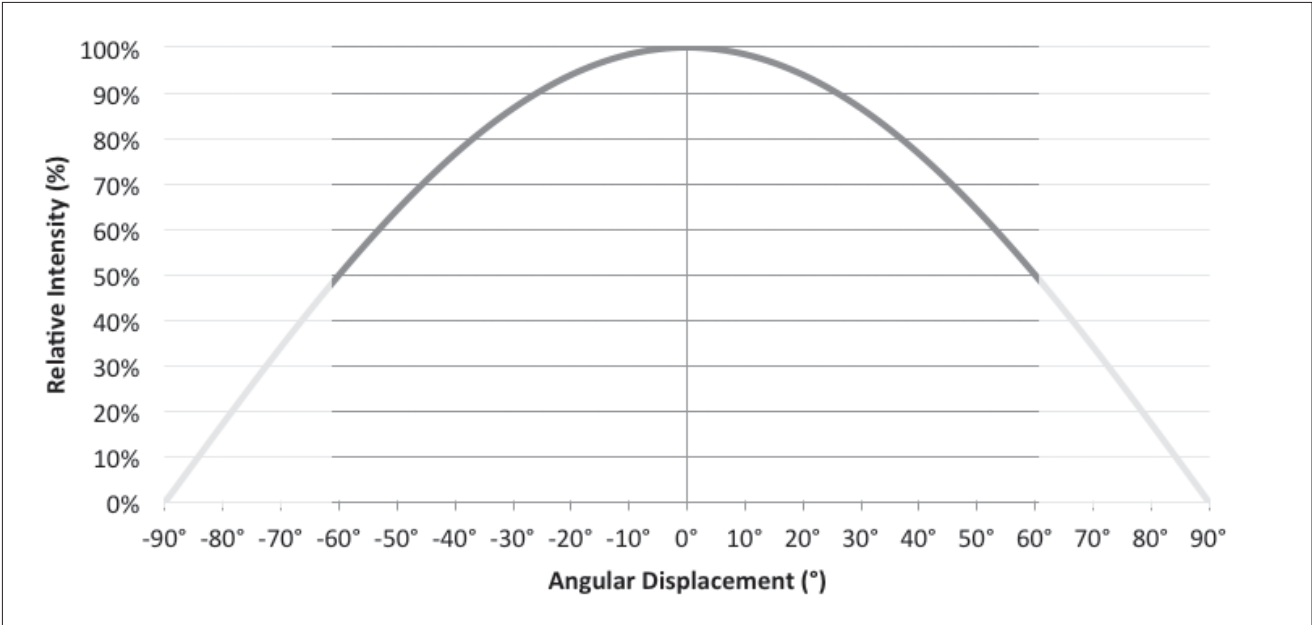

Note for Figure 6:

- 1. Typical viewing angle is 120°.
- 2. The viewing angle is defined as the off axis angle from the centerline where intensity is 1/2 of the peak value.

Figure 7: Typical Polar Radiation Pattern

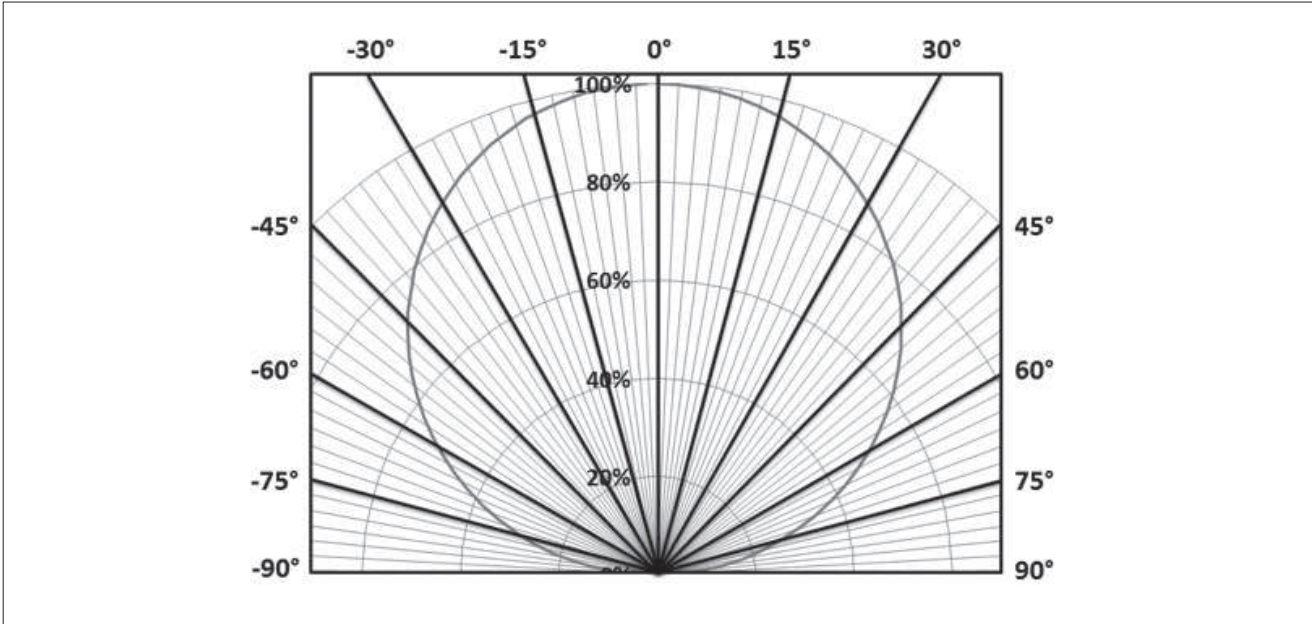

Typical Color Spectrum

Figure 8: Typical Color Spectrum

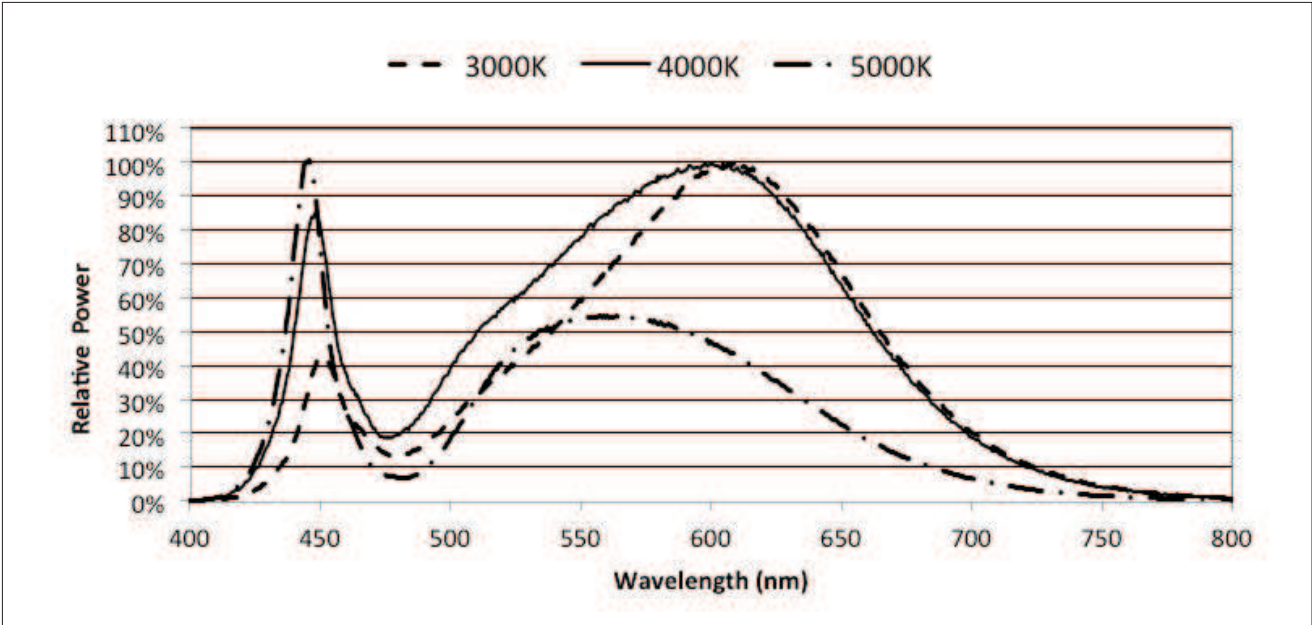

- Note for Figure 8:
1. Color spectra measured at nominal current for $T_j = T_c = 25^\circ\text{C}$.
 2. Color spectra shown is 3000K and 80 CRI.
 3. Color spectra shown is 4000K and 80 CRI.
 4. Color spectra shown is 5000K and 70 CRI.

Mechanical Dimensions

Figure 9: Drawing for Vero 13 LED Array

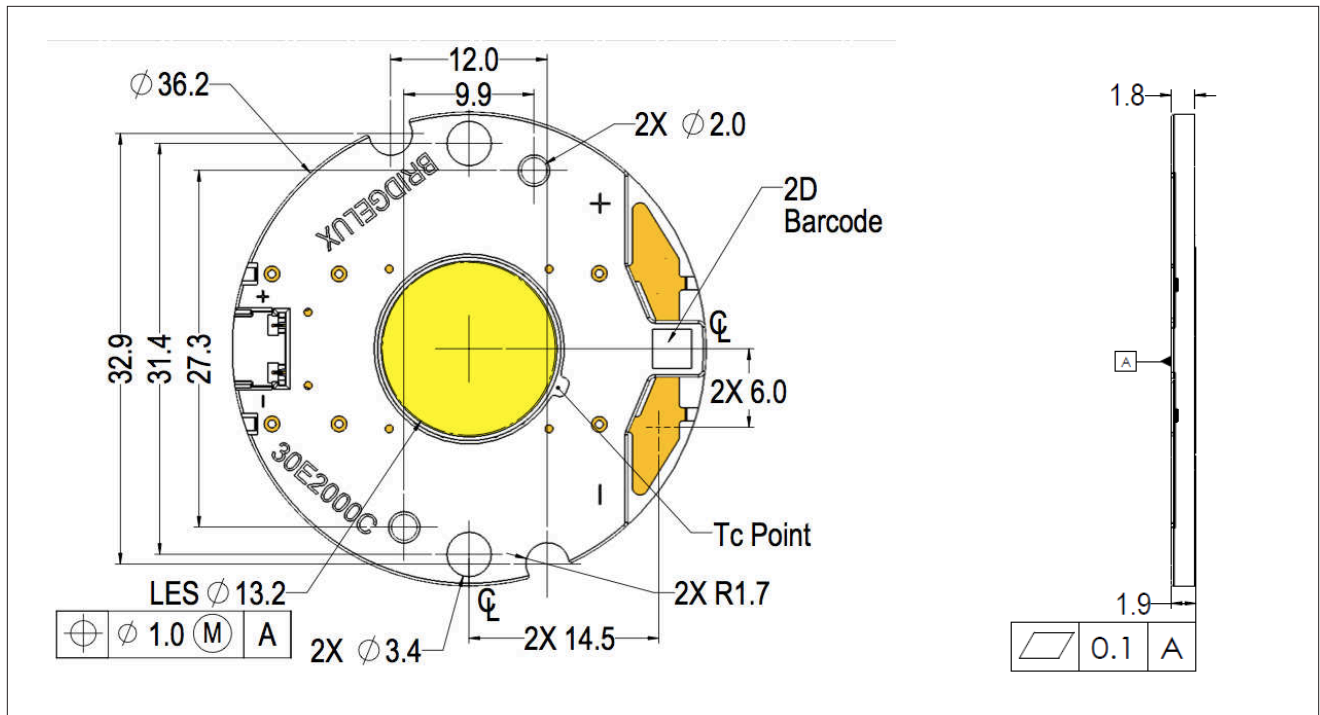

Notes for Figure 9:

1. Drawings are not to scale.
2. Drawing dimensions are in millimeters.
3. Unless otherwise specified, tolerances are ± 0.1 mm.
4. Mounting holes (2X) are for M2.5 screws.
5. Bridgelux recommends two tapped holes for mounting screws with 31.4 ± 0.10 mm center-to-center spacing.
6. Screws with flat shoulders (pan, dome, button, round, truss, mushroom) provide optimal torque control. Do NOT use flat, countersink, or raised head screws.
7. Solder pads and connector port are labeled "+" and "-" to denote positive and negative, respectively.
8. It is not necessary to provide electrical connections to both the solder pads and the connector port. Either set may be used depending on application specific design requirements.
9. Refer to Application Notes AN30 and AN31 for product handling, mounting and heat sink recommendations.
10. The optical center of the LED Array is nominally defined by the mechanical center of the array to a tolerance of ± 0.2 mm.
11. Bridgelux maintains a flatness of 0.10mm across the mounting surface of the array.

Color Binning Information

Figure 10: Graph of Warm and Neutral White Test Bins in xy Color Space

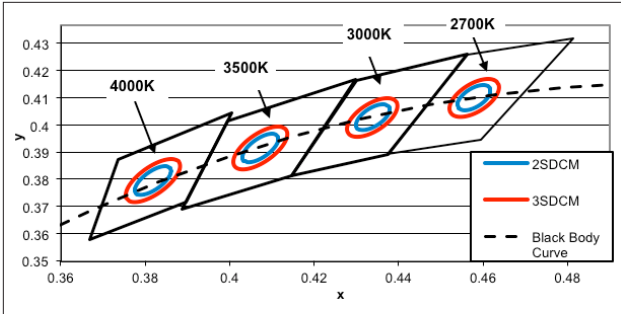

Note: Pulsed Test Conditions, $T_c = 25^\circ\text{C}$

Table 6: Warm and Neutral White xy Bin Coordinates and Associated Typical CCT

Bin Code	2700K	3000K	3500K	4000K
ANSI Bin (for reference only)	(2580K - 2870K)	(2870K - 3220K)	(3220K - 3710K)	(3710K - 4260K)
23 (3SDCM)	(2651K - 2794K)	(2968K - 3136K)	(3369K - 3586K)	(3851K - 4130K)
22 (2SDCM)	(2674K - 2769K)	(2995K - 3107K)	(3404K - 3548K)	(3895K - 4081K)
Center Point (x,y)	(0.4578, 0.4101)	(0.4338, 0.403)	(0.4073, 0.3917)	(0.3818, 0.3797)

Figure 11: Graph of Cool White Test Bins in xy Color Space

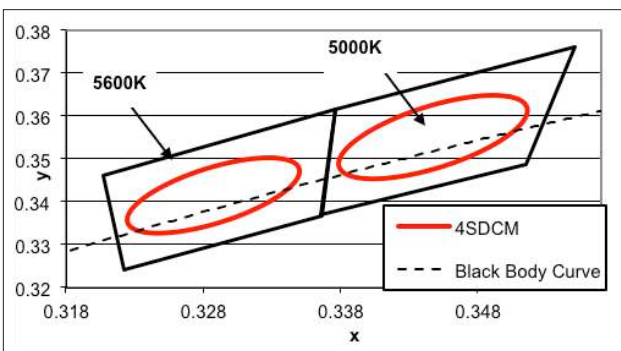

Note: Pulsed Test Conditions, $T_c = 25^\circ\text{C}$

Table 7: Cool White xy Bin Coordinates and Associated Typical CCT

Bin Code	5000K	5600K
ANSI Bin (for reference only)	(4745K - 5311K)	(5310K - 6020K)
24 (4SDCM)	(4801K - 5282K)	(5475K - 5830K)
Center Point (x,y)	(0.3447, 0.3553)	(0.3293, 0.3423)

Packaging and Labeling

Figure 12: Drawing for Vero 13 Packaging Tray

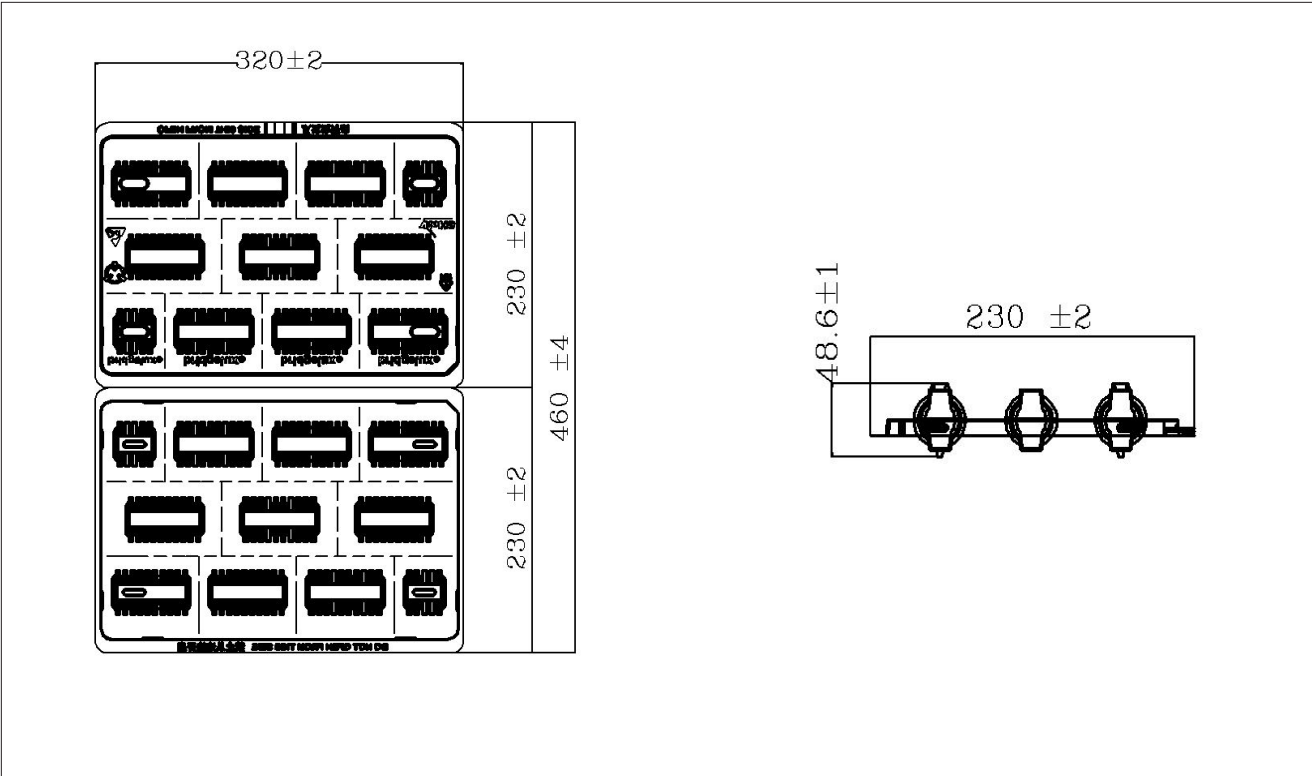

- Notes for Figure 12:
- 1. Dimensions are in millimeters.
 - 2. Drawings are not to scale.

Packaging and Labeling

Figure 13: Vero Series Packaging and Labeling

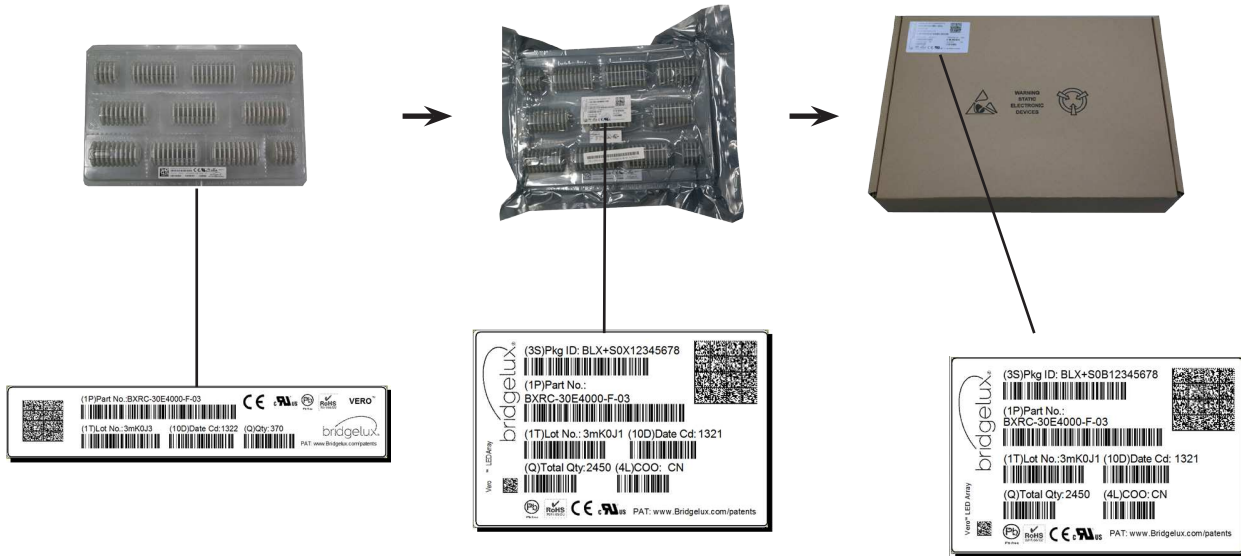

Notes for Figure 13:

1. Each tray holds 100 COBs.
2. Each tray is vacuum sealed in an anti-static bag and placed in its own box.
3. Each tray, bag and box is to be labeled as shown above.

Figure 14: Product Labeling

Bridgelux COB arrays have laser markings on the back side of the substrate to help with product identification. In addition to the product identification markings, Bridgelux COB arrays also contain markings for internal Bridgelux manufacturing use only. The image below shows which markings are for customer use and which ones are for Bridgelux internal use only. The Bridgelux internal manufacturing markings are subject to change without notice, however these will not impact the form, function or performance of the COB array.



Design Resources

Application Notes

Bridgelux has developed a comprehensive set of application notes and design resources to assist customers in successfully designing with the Vero product family of LED array products. For all available application notes visit www.bridgelux.com.

Optical Source Models

Optical source models and ray set files are available for all Bridgelux products. For a list of available formats, visit www.bridgelux.com.

3D CAD Models

Three dimensional CAD models depicting the product outline of all Bridgelux Vero LED arrays are available in both IGS and STEP formats. Please contact your Bridgelux sales representative for assistance.

Precautions

CAUTION: CHEMICAL EXPOSURE HAZARD

Exposure to some chemicals commonly used in luminaire manufacturing and assembly can cause damage to the LED array. Please consult Bridgelux Application Note AN31 for additional information.

CAUTION: EYE SAFETY

Eye safety classification for the use of Bridgelux Vero LED arrays is in accordance with IEC specification EN62471: Photobiological Safety of Lamps and Lamp Systems. Vero LED arrays are classified as Risk Group 1 (Low Risk) when operated at or below the maximum drive current. Please use appropriate precautions. It is important that employees working with LEDs are trained to use them safely.

CAUTION: RISK OF BURN

Do not touch the Vero LED array during operation. Allow the array to cool for a sufficient period of time before handling. The Vero LED array may reach elevated temperatures such that could burn skin when touched.

CAUTION

CONTACT WITH LIGHT EMITTING SURFACE (LES)

Avoid any contact with the LES. Do not touch the LES of the LED array or apply stress to the LES (yellow phosphor resin area). Contact may cause damage to the LED array.

Optics and reflectors must not be mounted in contact with the LES (yellow phosphor resin area). Optical devices may be mounted on the top surface of the plastic housing of the Vero LED array. Use the mechanical features of the LED array housing, edges and/or mounting holes to locate and secure optical devices as needed.

Disclaimers

MINOR PRODUCT CHANGE POLICY

The rigorous qualification testing on products offered by Bridgelux provides performance assurance. Slight cosmetic changes that do not affect form, fit, or function may occur as Bridgelux continues product optimization.

STANDARD TEST CONDITIONS

Unless otherwise stated, array testing is performed at the nominal drive current.

About Bridgelux: We Build Light That Transforms

At Bridgelux, we help companies, industries and people experience the power and possibility of light. Since 2002, we've designed LED solutions that are high performing, energy efficient, cost effective and easy to integrate. Our focus is on light's impact on human behavior, delivering products that create better environments, experiences and returns—both experiential and financial. And our patented technology drives new platforms for commercial and industrial luminaires.

For more information about the company, please visit
bridgelux.com
twitter.com/Bridgelux
facebook.com/Bridgelux
WeChat ID: BridgeluxInChina



101 Portola Avenue
Livermore, CA 94551
Tel (925) 583-8400
Fax (925) 583-8410
www.bridgelux.com

© 2016 Bridgelux, Inc. All rights reserved 2016. Product specifications are subject to change without notice. Bridgelux, the Bridgelux stylized logo design and Vero are registered trademarks, and Decor Series is a trademark of Bridgelux, Inc. All other trademarks are the property of their respective owners.

Bridgelux Vero 13 Array Series Product Data Sheet DS31 Rev. L (06/2016)