



Chipsmall Limited consists of a professional team with an average of over 10 year of expertise in the distribution of electronic components. Based in Hongkong, we have already established firm and mutual-benefit business relationships with customers from,Europe,America and south Asia,supplying obsolete and hard-to-find components to meet their specific needs.

With the principle of “Quality Parts,Customers Priority,Honest Operation,and Considerate Service”,our business mainly focus on the distribution of electronic components. Line cards we deal with include Microchip,ALPS,ROHM,Xilinx,Pulse,ON,Everlight and Freescale. Main products comprise IC,Modules,Potentiometer,IC Socket,Relay,Connector.Our parts cover such applications as commercial,industrial, and automotives areas.

We are looking forward to setting up business relationship with you and hope to provide you with the best service and solution. Let us make a better world for our industry!



## Contact us

Tel: +86-755-8981 8866 Fax: +86-755-8427 6832

Email & Skype: info@chipsmall.com Web: www.chipsmall.com

Address: A1208, Overseas Decoration Building, #122 Zhenhua RD., Futian, Shenzhen, China



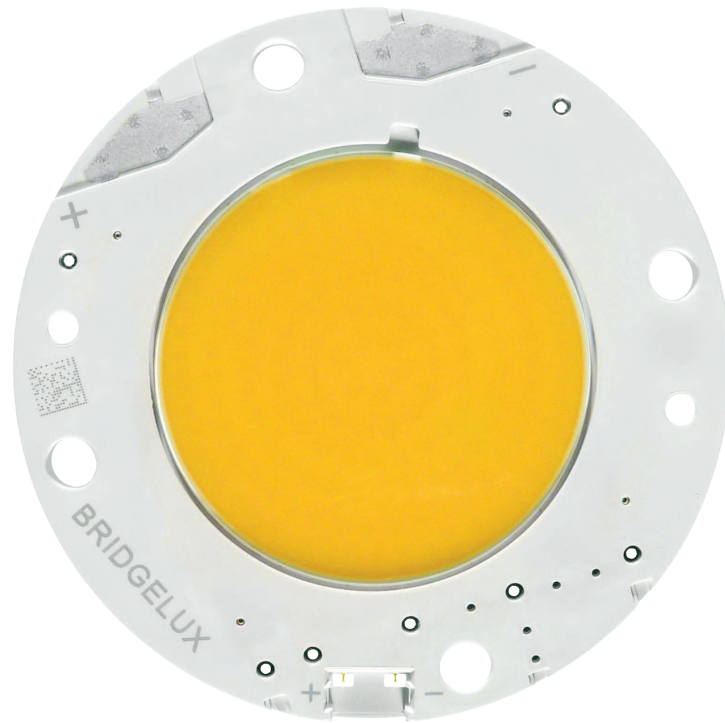

# Bridgelux® Gen 7 Vero® 29 Array Series

Product Data Sheet DS93



BXRC-27x10K0 | 30x10K0 | 35x10K0 | 40x10K0 | 50x10K1 | 57x10K1 | 65x10K1

# Introduction

Vero



Vero represents a revolutionary advancement in chip on board (COB) light source technology and innovation. Vero LED light sources simplify luminaire design and manufacturing processes, improve light quality, and define a platform for future functionality integration.

Vero is available in four different light emitting surface (LES) configurations and has been engineered to reliably operate over a broad current range, enabling new degrees of flexibility in luminaire design optimization. Vero arrays deliver increased lumen density to enable improved beam control and precision lighting with 2 and 3 SDCM color control standard for clean and consistent uniform lighting.

Vero includes an on board connector port to enable solder free electrical interconnect and simple easy to use mounting features to enable plug-and-play installation.

## Features

- Efficacy of 155 lm/W typical
- Vero 29 lumen output performance ranges from 5,244 to 37,266 lumens
- Broad range of CCT options from 2700K to 5000K
- CRI options include minimum 70, 80, and 90, 2 and 3 SDCM color control for 2700K-4000K CCT
- Reliable operation at up to 2X nominal drive current
- Radial die pattern and improved lumen density
- Thermally isolated solder pads
- Onboard connector port
- Top side part number markings

## Benefits

- Broad application coverage for interior and exterior lighting
- Flexibility for application driven lighting design requirements
- High quality true color reproduction
- Uniform consistent white light
- Flexibility in design optimization
- Improved optical control
- Enhanced ease of use and manufacturability
- Solderless connectivity enables plug & play installation and field upgradability
- Improved inventory management and quality control



Pending Standards and Classifications: ENEC

# Contents

Product Feature Map	2
Product Nomenclature	2
Product Selection Guide	3
Performance at Commonly Used Drive Currents	7
Electrical Characteristics	13
Absolute Maximum Ratings	14
Performance Curves	15
Typical Radiation Pattern	20
Typical Color Spectrum	21
Mechanical Dimensions	22
Color Binning Information	23
Packaging and Labeling	24
Design Resources	26
Precautions	26
Disclaimers	26
About Bridgelux	27

---



# Product Feature Map

Vero 29 is the largest form factor in the Vero family of next generation solid state light sources. In addition to delivering the performance and light quality required for many lighting applications, Vero incorporates several

features to simplify the design integration and manufacturing process, accelerate time to market and reduce system costs. Please consult the Bridgelux Vero Array Series Product Brief for more information on the Vero family of products.

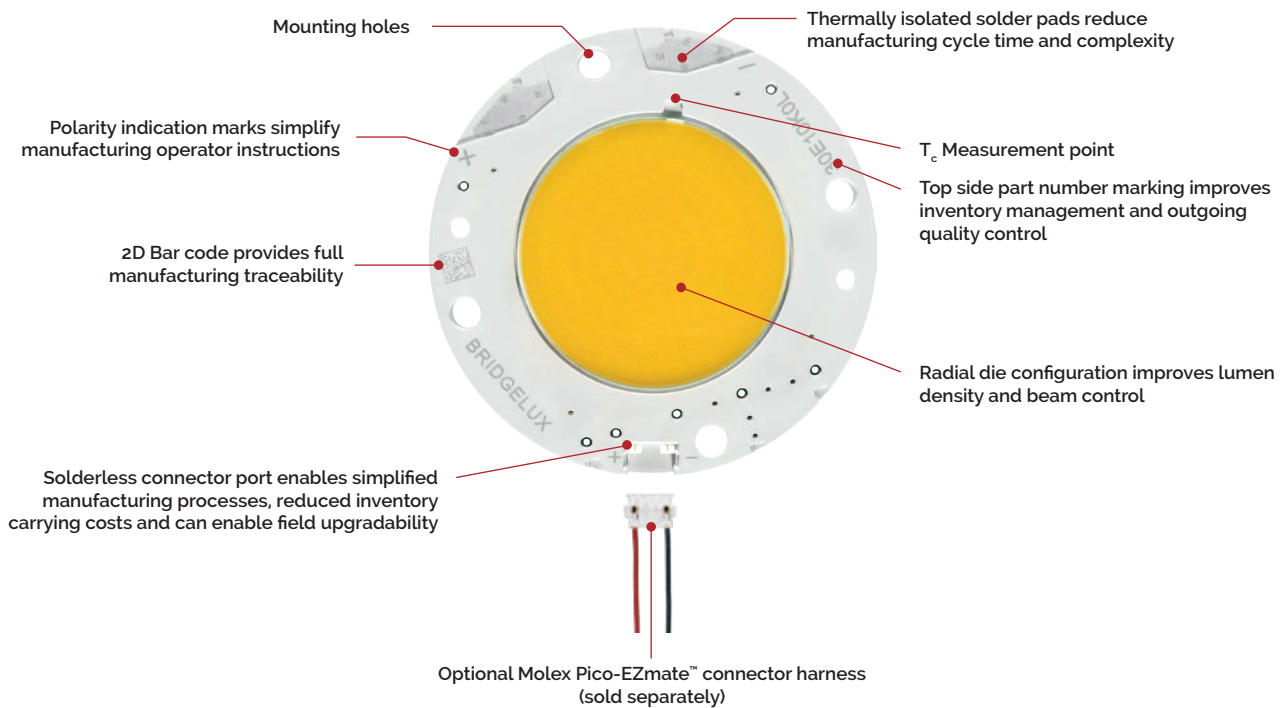

## Product Nomenclature

The part number designation for Bridgelux Vero 29 LED arrays is explained as follows:

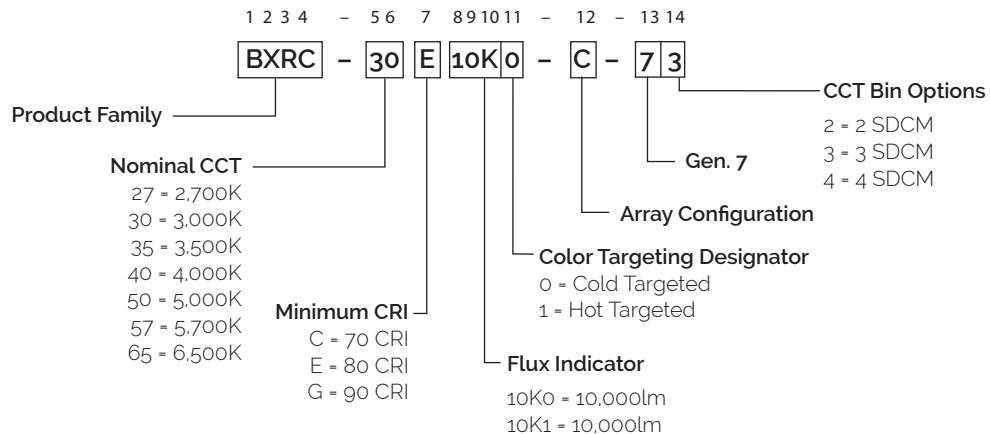

# Product Selection Guide

The following product configurations are available:

**Table 1:** Selection Guide, Pulsed Measurement Data ( $T_j = T_c = 25^\circ\text{C}$ )

Part Number	Nominal CCT <sup>1</sup> (K)	CRI <sup>2</sup>	Nominal Drive Current <sup>3</sup> (mA)	Typical Pulsed Flux <sup>4,5,6</sup> $T_c = 25^\circ\text{C}$ (lm)	Minimum Pulsed Flux <sup>6,7</sup> $T_c = 25^\circ\text{C}$ (lm)	Typical $V_f$ (V)	Typical Power (W)	Typical Efficacy (lm/W)
BXRC-27E10K0-B-7X	2700	80	1800	13934	12819	52.0	93.6	149
BXRC-27E10K0-C-7X	2700	80	1710	17649	16237	69.4	118.7	149
BXRC-27E10K0-D-7X	2700	80	2100	11740	10800	38.7	81.3	144
BXRC-27G10K0-B-7X	2700	90	1800	11611	10682	52.0	93.6	124
BXRC-27G10K0-C-7X	2700	90	1710	14708	13531	69.4	118.7	124
BXRC-27G10K0-D-7X	2700	90	2100	9784	9000	38.7	81.3	120
BXRC-30E10K0-B-7X	3000	80	1800	14514	13353	52.0	93.6	155
BXRC-30E10K0-C-7X	3000	80	1710	18385	16914	69.4	118.7	155
BXRC-30E10K0-D-7X	3000	80	2100	12597	11250	38.7	81.3	155
BXRC-30G10K0-B-7X	3000	90	1800	12047	11083	52.0	93.6	129
BXRC-30G10K0-C-7X	3000	90	1710	15259	14038	69.4	118.7	129
BXRC-30G10K0-D-7X	3000	90	2100	10150	9338	38.7	81.3	125
BXRC-35E10K0-B-7X	3500	80	1800	14950	13754	52.0	93.6	160
BXRC-35E10K0-C-7X	3500	80	1710	18936	17421	69.4	118.7	160
BXRC-35E10K0-D-7X	3500	80	2100	12596	11588	38.7	81.3	155
BXRC-35G10K0-B-7X	3500	90	1800	12482	11484	52.0	93.6	133
BXRC-35G10K0-C-7X	3500	90	1710	15811	14546	69.4	118.7	133
BXRC-35G10K0-D-7X	3500	90	2100	10517	9675	38.7	81.3	129
BXRC-40E10K0-B-7X	4000	80	1800	15095	13887	52.0	93.6	161
BXRC-40E10K0-C-7X	4000	80	1710	19120	17590	69.4	118.7	161
BXRC-40E10K0-D-7X	4000	80	2100	12719	11700	38.7	81.3	156
BXRC-40G10K0-B-7X	4000	90	1800	12918	11884	52.0	93.6	138
BXRC-40G10K0-C-7X	4000	90	1710	16362	15053	69.4	118.7	138
BXRC-40G10K0-D-7X	4000	90	2100	10884	10013	38.7	81.3	134
BXRC-50C10K1-B-74	5000	70	1800	16546	15222	52.0	93.6	177
BXRC-50C10K1-C-74	5000	70	1710	20958	19282	69.4	118.7	177
BXRC-50C10K1-D-74	5000	70	2100	13942	12825	38.7	81.3	172
BXRC-50E10K1-B-74	5000	80	1800	15553	14309	52.0	93.6	166
BXRC-50E10K1-C-74	5000	80	1710	19701	18125	69.4	118.7	166
BXRC-50E10K1-D-74	5000	80	2100	13105	12056	38.7	81.3	161

Notes for Tables 1:

1. Nominal CCT as defined by ANSI C78.377-2011. Products with CCTs 5000K-6500K are hot targeted to 85°C.
2. CRI values are minimums. Minimum R<sub>g</sub> value for 80 CRI products is 0, the minimum R<sub>g</sub> values for 90 CRI products is 50.
3. Drive current is referred to as nominal drive current.
4. Products tested under pulsed condition (10ms pulse width) at nominal test current where  $T_j$  (junction temperature) =  $T_c$  (case temperature) = 25°C.
5. Typical performance values are provided as a reference only and are not a guarantee of performance.
6. Bridgelux maintains a ±7% tolerance on flux measurements.
7. Minimum flux values at the nominal test current are guaranteed by 100% test.

# Product Selection Guide

The following product configurations are available:

**Table 1:** Selection Guide, Pulsed Measurement Data ( $T_j = T_c = 25^\circ\text{C}$ ) (continued)

Part Number	Nominal CCT <sup>1</sup> (K)	CRI <sup>2</sup>	Nominal Drive Current <sup>3</sup> (mA)	Typical Pulsed Flux <sup>4,5,6</sup> $T_c = 25^\circ\text{C}$ (lm)	Minimum Pulsed Flux <sup>6,7</sup> $T_c = 25^\circ\text{C}$ (lm)	Typical $V_f$ (V)	Typical Power (W)	Typical Efficacy (lm/W)
BXRC-50G10K1-B-74	5000	90	1800	13237	12178	52.0	93.6	141
BXRC-50G10K1-C-74	5000	90	1710	16767	15425	69.4	118.7	141
BXRC-50G10K1-D-74	5000	90	2100	11153	10260	38.7	81.3	137
BXRC-57C10K1-B-74	5700	70	1800	15966	14688	52.0	93.6	171
BXRC-57C10K1-C-74	5700	70	1710	20223	18605	69.4	118.7	170
BXRC-57C10K1-D-74	5700	70	2100	13452	12375	38.7	81.3	166
BXRC-57E10K1-B-74	5700	80	1800	15820	14555	52.0	93.6	169
BXRC-57E10K1-C-74	5700	80	1710	20039	18436	69.4	118.7	169
BXRC-57E10K1-D-74	5700	80	2100	13330	12263	38.7	81.3	164
BXRC-65C10K1-B-74	6500	70	1800	16256	14955	52.0	93.6	174
BXRC-65C10K1-C-74	6500	70	1710	20591	18943	69.4	118.7	174
BXRC-65C10K1-D-74	6500	70	2100	13697	12600	38.7	81.3	169
BXRC-65E10K1-B-74	6500	80	1800	16111	14822	52.0	93.6	172
BXRC-65E10K1-C-74	6500	80	1710	20407	18774	69.4	118.7	172
BXRC-65E10K1-D-74	6500	80	2100	13575	12488	38.7	81.3	167

Notes for Table 1:

1. Nominal CCT as defined by ANSI C78.377-2011. Products with a CCT of 5000K-6500K are hot targeted to 85°C.
2. CRI values are minimums. Minimum Rg value for 80 CRI products is 0, the minimum Rg values for 90 CRI products is 50.
3. Drive current is referred to as nominal drive current.
4. Products tested under pulsed condition (10ms pulse width) at nominal test current where  $T_j$  (junction temperature) =  $T_c$  (case temperature) = 25°C.
5. Typical performance values are provided as a reference only and are not a guarantee of performance.
6. Bridgelux maintains a ±7% tolerance on flux measurements.
7. Minimum flux values at the nominal test current are guaranteed by 100% test.

# Product Selection Guide

**Table 2:** Selection Guide, Stabilized DC Performance ( $T_c = 85^\circ\text{C}$ )<sup>4,5</sup>

Part Number	Nominal CCT <sup>1</sup> (K)	CRI <sup>2</sup>	Nominal Drive Current <sup>3</sup> (mA)	Typical DC Flux <sup>4,5</sup> $T_c = 85^\circ\text{C}$ (lm)	Minimum DC Flux <sup>6</sup> $T_c = 85^\circ\text{C}$ (lm)	Typical $V_f$ (V)	Typical Power (W)	Typical Efficacy (lm/W)
BXRC-27E10K0-B-7X	2700	80	1800	12540	11537	50.7	91.2	137
BXRC-27E10K0-C-7X	2700	80	1710	15884	14614	68.1	116.4	136
BXRC-27E10K0-D-7X	2700	80	2100	10566	9720	37.7	79.1	134
BXRC-27G10K0-B-7X	2700	90	1800	10450	9614	50.7	91.2	115
BXRC-27G10K0-C-7X	2700	90	1710	13237	12178	68.1	116.4	114
BXRC-27G10K0-D-7X	2700	90	2100	8805	8100	37.7	79.1	111
BXRC-30E10K0-B-7X	3000	80	1800	13063	12018	50.7	91.2	143
BXRC-30E10K0-C-7X	3000	80	1710	16546	15222	68.1	116.4	142
BXRC-30E10K0-D-7X	3000	80	2100	11337	10125	37.7	79.1	143
BXRC-30G10K0-B-7X	3000	90	1800	10842	9975	50.7	91.2	119
BXRC-30G10K0-C-7X	3000	90	1710	13733	12635	68.1	116.4	118
BXRC-30G10K0-D-7X	3000	90	2100	9135	8404	37.7	79.1	116
BXRC-35E10K0-B-7X	3500	80	1800	13455	12378	50.7	91.2	148
BXRC-35E10K0-C-7X	3500	80	1710	17042	15679	68.1	116.4	146
BXRC-35E10K0-D-7X	3500	80	2100	11337	10429	37.7	79.1	143
BXRC-35G10K0-B-7X	3500	90	1800	11234	10335	50.7	91.2	123
BXRC-35G10K0-C-7X	3500	90	1710	14230	13091	68.1	116.4	122
BXRC-35G10K0-D-7X	3500	90	2100	9466	8708	37.7	79.1	120
BXRC-40E10K0-B-7X	4000	80	1800	13585	12498	50.7	91.2	149
BXRC-40E10K0-C-7X	4000	80	1710	17208	15831	68.1	116.4	148
BXRC-40E10K0-D-7X	4000	80	2100	11447	10530	37.7	79.1	145
BXRC-40G10K0-B-7X	4000	90	1800	11626	10696	50.7	91.2	127
BXRC-40G10K0-C-7X	4000	90	1710	14726	13548	68.1	116.4	127
BXRC-40G10K0-D-7X	4000	90	2100	9796	9011	37.7	79.1	124
BXRC-50C10K1-B-74	5000	70	1800	14892	13700	50.7	91.2	163
BXRC-50C10K1-C-74	5000	70	1710	18863	17354	68.1	116.4	162
BXRC-50C10K1-D-74	5000	70	2100	12547	11543	37.7	79.1	159
BXRC-50E10K1-B-74	5000	80	1800	13998	12878	50.7	91.2	153
BXRC-50E10K1-C-74	5000	80	1710	17731	16312	68.1	116.4	152
BXRC-50E10K1-D-74	5000	80	2100	11795	10850	37.7	79.1	149

Notes for Tables 2:

- Nominal CCT as defined by ANSI C78.377-2011. Products with a CCT of 5000K-6500K are hot targeted to 85°C.
- CRI values are minimums. Minimum Rg value for 80 CRI products is 0, the minimum Rg values for 90 CRI products is 50.
- Drive current is referred to as nominal drive current.
- Typical stabilized DC performance values are provided as reference only and are not a guarantee of performance.
- Typical performance is estimated based on operation under DC (direct current) with LED array mounted onto a heat sink with thermal interface material and the case temperature maintained at 85°C. Based on Bridgelux test setup, values may vary depending on the thermal design of the luminaire and/or the exposed environment to which the product is subjected.
- Minimum flux values at elevated temperatures are provided for reference only and are not guaranteed by 100% production testing. Based on Bridgelux test setup, values may vary depending on the thermal design of the luminaire and/or the exposed environment to which the product is subjected.



# Product Selection Guide

**Table 2:** Selection Guide, Stabilized DC Performance ( $T_c = 85^\circ\text{C}$ )<sup>4,5</sup> (continued)

Part Number	Nominal CCT <sup>1</sup> (K)	CRI <sup>2</sup>	Nominal Drive Current <sup>3</sup> (mA)	Typical DC Flux <sup>4,5</sup> $T_c = 85^\circ\text{C}$ (lm)	Minimum DC Flux <sup>6</sup> $T_c = 85^\circ\text{C}$ (lm)	Typical $V_f$ (V)	Typical Power (W)	Typical Efficacy (lm/W)
BXRC-50G10K1-B-74	5000	90	1800	11913	10960	50.7	91.2	131
BXRC-50G10K1-C-74	5000	90	1710	15090	13883	68.1	116.4	130
BXRC-50G10K1-D-74	5000	90	2100	10038	9234	37.7	79.1	127
BXRC-57C10K1-B-74	5700	70	1800	14369	13220	50.7	91.2	158
BXRC-57C10K1-C-74	5700	70	1710	18201	16745	68.1	116.4	156
BXRC-57C10K1-D-74	5700	70	2100	12107	11138	37.7	79.1	153
BXRC-57E10K1-B-74	5700	80	1800	14238	13099	50.7	91.2	156
BXRC-57E10K1-C-74	5700	80	1710	18035	16592	68.1	116.4	155
BXRC-57E10K1-D-74	5700	80	2100	11997	11036	37.7	79.1	152
BXRC-65C10K1-B-74	6500	70	1800	14630	13460	50.7	91.2	160
BXRC-65C10K1-C-74	6500	70	1710	18532	17049	68.1	116.4	159
BXRC-65C10K1-D-74	6500	70	2100	12327	11340	37.7	79.1	156
BXRC-65E10K1-B-74	6500	80	1800	14500	13340	50.7	91.2	159
BXRC-65E10K1-C-74	6500	80	1710	18366	16897	68.1	116.4	158
BXRC-65E10K1-D-74	6500	80	2100	12217	11239	37.7	79.1	154

Notes for Tables 2:

1. Nominal CCT as defined by ANSI C78.377-2011. Products with a CCT of 5000K-6500K are hot targeted to 85°C.
2. CRI values are minimums. Minimum R9 value for 80 CRI products is 0, the minimum R9 values for 90 CRI products is 50.
3. Drive current is referred to as nominal drive current.
4. Typical stabilized DC performance values are provided as reference only and are not a guarantee of performance.
5. Typical performance is estimated based on operation under DC (direct current) with LED array mounted onto a heat sink with thermal interface material and the case temperature maintained at 85°C. Based on Bridgelux test setup, values may vary depending on the thermal design of the luminaire and/or the exposed environment to which the product is subjected.
6. Minimum flux values at elevated temperatures are provided for reference only and are not guaranteed by 100% production testing. Based on Bridgelux test setup, values may vary depending on the thermal design of the luminaire and/or the exposed environment to which the product is subjected.

# Performance at Commonly Used Drive Currents

Vero LED arrays are tested to the specifications shown using the nominal drive currents in Table 1. Vero may also be driven at other drive currents dependent on specific application design requirements. The performance at any drive current can be derived from the current vs. voltage characteristics shown in Figures 1, 2 & 3 and the flux vs. current characteristics shown in Figures 4, 5 & 6. The performance at commonly used drive currents is summarized in Table 3.

**Table 3:** Product Performance at Commonly Used Drive Currents

Part Number	CRI	Drive Current <sup>1</sup> (mA)	Typical $V_f$ $T_c = 25^\circ\text{C}$ (V)	Typical Power $T_c = 25^\circ\text{C}$ (W)	Typical Flux <sup>2</sup> $T_c = 25^\circ\text{C}$ (lm)	Typical DC Flux <sup>3</sup> $T_c = 85^\circ\text{C}$ (lm)	Typical Efficacy $T_c = 25^\circ\text{C}$ (lm/W)
BXRC-27E10K0-B-7X	80	900	49.6	44.7	7301	7311	163
		1200	50.5	60.6	9634	9138	159
		<b>1800</b>	<b>52.0</b>	<b>93.6</b>	<b>13934</b>	<b>12540</b>	<b>149</b>
		2700	54.1	146.1	20544	17143	141
		3600	55.8	201.0	26488	21043	132
BXRC-27E10K0-C-7X	80	855	66.2	56.6	10026	9541	177
		1140	67.3	76.7	12743	11755	166
		<b>1710</b>	<b>69.4</b>	<b>118.7</b>	<b>17649</b>	<b>15884</b>	<b>149</b>
		2565	72.1	185.0	25038	21534	135
		3420	74.4	254.6	31382	26370	123
BXRC-27E10K0-D-7X	80	1050	36.5	38.3	6458	6292	169
		1400	37.2	52.1	8311	7735	159
		<b>2100</b>	<b>38.7</b>	<b>81.3</b>	<b>11740</b>	<b>10566</b>	<b>144</b>
		3150	40.6	128.0	16714	14083	131
		4200	42.4	178.0	21066	17202	118
BXRC-27G10K0-B-7X	90	900	49.6	44.7	6084	6092	136
		1200	50.5	60.6	8028	7615	133
		<b>1800</b>	<b>52.0</b>	<b>93.6</b>	<b>11611</b>	<b>10450</b>	<b>124</b>
		2700	54.1	146.1	17120	14285	117
		3600	55.8	201.0	22073	17535	110
BXRC-27G10K0-C-7X	90	855	66.2	56.6	8355	7950	148
		1140	67.3	76.7	10619	9795	138
		<b>1710</b>	<b>69.4</b>	<b>118.7</b>	<b>14708</b>	<b>13237</b>	<b>124</b>
		2565	72.1	185.0	20865	17945	113
		3420	74.4	254.6	26152	21975	103
BXRC-27G10K0-D-7X	90	1050	36.5	38.3	5381	5244	141
		1400	37.2	52.1	6926	6445	133
		<b>2100</b>	<b>38.7</b>	<b>81.3</b>	<b>9784</b>	<b>8805</b>	<b>120</b>
		3150	40.6	128.0	13928	11736	109
		4200	42.4	178.0	17555	14335	99

Notes for Table 3:

1. Alternate drive currents in Table 3 are provided for reference only and are not a guarantee of performance.
2. Bridgelux maintains a  $\pm 7\%$  tolerance on flux measurements.
3. Typical stabilized DC performance values are provided as reference only and are not a guarantee of performance.

# Performance at Commonly Used Drive Currents

**Table 3:** Product Performance at Commonly Used Drive Currents (Continued)

Part Number	CRI	Drive Current <sup>1</sup> (mA)	Typical $V_f$ $T_c = 25^\circ\text{C}$ (V)	Typical Power $T_c = 25^\circ\text{C}$ (W)	Typical Flux <sup>2</sup> $T_c = 25^\circ\text{C}$ (lm)	Typical DC Flux <sup>3</sup> $T_c = 85^\circ\text{C}$ (lm)	Typical Efficacy $T_c = 25^\circ\text{C}$ (lm/W)
BXRC-30E10Ko-B-7X	80	900	49.6	44.7	7605	7616	170
		1200	50.5	60.6	10035	9518	166
		<b>1800</b>	<b>52.0</b>	<b>93.6</b>	<b>14514</b>	<b>13063</b>	<b>155</b>
		2700	54.1	146.1	21400	17857	147
		3600	55.8	201.0	27591	21919	137
BXRC-30E10Ko-C-7X	80	855	66.2	56.6	10444	9938	185
		1140	67.3	76.7	13274	12244	173
		<b>1710</b>	<b>69.4</b>	<b>118.7</b>	<b>18385</b>	<b>16546</b>	<b>155</b>
		2565	72.1	185.0	26081	22431	141
		3420	74.4	254.6	32690	27469	128
BXRC-30E10Ko-D-7X	80	1050	36.5	38.3	6929	6751	181
		1400	37.2	52.1	8917	8299	171
		<b>2100</b>	<b>38.7</b>	<b>81.3</b>	<b>12597</b>	<b>11337</b>	<b>155</b>
		3150	40.6	128.0	17934	15111	140
		4200	42.4	178.0	22603	18457	127
BXRC-30G10Ko-B-7X	90	900	49.6	44.7	6313	6321	141
		1200	50.5	60.6	8329	7900	138
		<b>1800</b>	<b>52.0</b>	<b>93.6</b>	<b>12047</b>	<b>10842</b>	<b>129</b>
		2700	54.1	146.1	17762	14821	122
		3600	55.8	201.0	22901	18193	114
BXRC-30G10Ko-C-7X	90	855	66.2	56.6	8668	8249	153
		1140	67.3	76.7	11017	10163	144
		<b>1710</b>	<b>69.4</b>	<b>118.7</b>	<b>15259</b>	<b>13733</b>	<b>129</b>
		2565	72.1	185.0	21647	18618	117
		3420	74.4	254.6	27132	22799	107
BXRC-30G10Ko-D-7X	90	1050	36.5	38.3	5583	5440	146
		1400	37.2	52.1	7186	6687	138
		<b>2100</b>	<b>38.7</b>	<b>81.3</b>	<b>10150</b>	<b>9135</b>	<b>125</b>
		3150	40.6	128.0	14451	12176	113
		4200	42.4	178.0	18213	14872	102
BXRC-35E10Ko-B-7X	80	900	49.6	44.7	7834	7844	175
		1200	50.5	60.6	10336	9804	171
		<b>1800</b>	<b>52.0</b>	<b>93.6</b>	<b>14950</b>	<b>13455</b>	<b>160</b>
		2700	54.1	146.1	22042	18393	151
		3600	55.8	201.0	28419	22577	141
BXRC-35E10Ko-C-7X	80	855	66.2	56.6	10757	10236	190
		1140	67.3	76.7	13672	12612	178
		<b>1710</b>	<b>69.4</b>	<b>118.7</b>	<b>18936</b>	<b>17042</b>	<b>160</b>
		2565	72.1	185.0	26863	23104	145
		3420	74.4	254.6	33670	28293	132
BXRC-35E10Ko-D-7X	80	1050	36.5	38.3	6929	6751	181
		1400	37.2	52.1	8917	8298	171
		<b>2100</b>	<b>38.7</b>	<b>81.3</b>	<b>12596</b>	<b>11337</b>	<b>155</b>
		3150	40.6	128.0	17933	15110	140
		4200	42.4	178.0	22602	18456	127

Notes for Table 3:

1. Alternate drive currents in Table 3 are provided for reference only and are not a guarantee of performance.
2. Bridgelux maintains a  $\pm 7\%$  tolerance on flux measurements.
3. Typical stabilized DC performance values are provided as reference only and are not a guarantee of performance.

# Performance at Commonly Used Drive Currents

**Table 3:** Product Performance at Commonly Used Drive Currents (Continued)

Part Number	CRI	Drive Current <sup>1</sup> (mA)	Typical V <sub>f</sub> T <sub>c</sub> = 25°C (V)	Typical Power T <sub>c</sub> = 25°C (W)	Typical Flux <sup>2</sup> T <sub>c</sub> = 25°C (lm)	Typical DC Flux <sup>3</sup> T <sub>c</sub> = 85°C (lm)	Typical Efficacy T <sub>c</sub> = 25°C (lm/W)
BXRC-35G10Ko-B-7X	90	900	49.6	44.7	6541	6549	146
		1200	50.5	60.6	8630	8186	143
		<b>1800</b>	<b>52.0</b>	<b>93.6</b>	<b>12482</b>	<b>11234</b>	<b>133</b>
		2700	54.1	146.1	18404	15357	126
		3600	55.8	201.0	23729	18851	118
BXRC-35G10Ko-C-7X	90	855	66.2	56.6	8982	8547	159
		1140	67.3	76.7	11416	10530	149
		<b>1710</b>	<b>69.4</b>	<b>118.7</b>	<b>15811</b>	<b>14230</b>	<b>133</b>
		2565	72.1	185.0	22429	19291	121
		3420	74.4	254.6	28113	23623	110
BXRC-35G10Ko-D-7X	90	1050	36.5	38.3	5785	5637	151
		1400	37.2	52.1	7445	6929	143
		<b>2100</b>	<b>38.7</b>	<b>81.3</b>	<b>10517</b>	<b>9466</b>	<b>129</b>
		3150	40.6	128.0	14973	12616	117
		4200	42.4	178.0	18871	15410	106
BXRC-40E10Ko-B-7X	80	900	49.6	44.7	7910	7920	177
		1200	50.5	60.6	10437	9899	172
		<b>1800</b>	<b>52.0</b>	<b>93.6</b>	<b>15095</b>	<b>13585</b>	<b>161</b>
		2700	54.1	146.1	22256	18571	152
		3600	55.8	201.0	28695	22796	143
BXRC-40E10Ko-C-7X	80	855	66.2	56.6	10861	10336	192
		1140	67.3	76.7	13805	12734	180
		<b>1710</b>	<b>69.4</b>	<b>118.7</b>	<b>19120</b>	<b>17208</b>	<b>161</b>
		2565	72.1	185.0	27124	23329	147
		3420	74.4	254.6	33997	28567	134
BXRC-40E10Ko-D-7X	80	1050	36.5	38.3	6996	6817	183
		1400	37.2	52.1	9004	8379	173
		<b>2100</b>	<b>38.7</b>	<b>81.3</b>	<b>12719</b>	<b>11447</b>	<b>156</b>
		3150	40.6	128.0	18107	15257	141
		4200	42.4	178.0	22821	18635	128
BXRC-40G10Ko-B-7X	90	900	49.6	44.7	6769	6778	152
		1200	50.5	60.6	8931	8471	147
		<b>1800</b>	<b>52.0</b>	<b>93.6</b>	<b>12918</b>	<b>11626</b>	<b>138</b>
		2700	54.1	146.1	19046	15893	130
		3600	55.8	201.0	24556	19508	122
BXRC-40G10Ko-C-7X	90	855	66.2	56.6	9295	8845	164
		1140	67.3	76.7	11814	10897	154
		<b>1710</b>	<b>69.4</b>	<b>118.7</b>	<b>16362</b>	<b>14726</b>	<b>138</b>
		2565	72.1	185.0	23212	19964	125
		3420	74.4	254.6	29094	24447	114
BXRC-40G10Ko-D-7X	90	1050	36.5	38.3	5987	5833	156
		1400	37.2	52.1	7705	7171	148
		<b>2100</b>	<b>38.7</b>	<b>81.3</b>	<b>10884</b>	<b>9796</b>	<b>134</b>
		3150	40.6	128.0	15495	13056	121
		4200	42.4	178.0	19530	15948	110

Notes for Table 3:

1. Alternate drive currents in Table 3 are provided for reference only and are not a guarantee of performance.
2. Bridgelux maintains a ± 7% tolerance on flux measurements.
3. Typical stabilized DC performance values are provided as reference only and are not a guarantee of performance.

# Performance at Commonly Used Drive Currents

**Table 3:** Product Performance at Commonly Used Drive Currents (Continued)

Part Number	CRI	Drive Current <sup>1</sup> (mA)	Typical $V_f$ $T_c = 25^\circ\text{C}$ (V)	Typical Power $T_c = 25^\circ\text{C}$ (W)	Typical Flux <sup>2</sup> $T_c = 25^\circ\text{C}$ (lm)	Typical DC Flux <sup>3</sup> $T_c = 85^\circ\text{C}$ (lm)	Typical Efficacy $T_c = 25^\circ\text{C}$ (lm/W)
BXRC-50C10K1-B-74	70	900	49.6	44.7	8670	8682	194
		1200	50.5	60.6	11440	10851	189
		<b>1800</b>	<b>52.0</b>	<b>93.6</b>	<b>16546</b>	<b>14892</b>	<b>177</b>
		2700	54.1	146.1	24396	20357	167
		3600	55.8	201.0	31454	24988	156
BXRC-50C10K1-C-74	70	855	66.2	56.6	11906	11329	210
		1140	67.3	76.7	15132	13959	197
		<b>1710</b>	<b>69.4</b>	<b>118.7</b>	<b>20958</b>	<b>18863</b>	<b>177</b>
		2565	72.1	185.0	29732	25572	161
		3420	74.4	254.6	37266	31314	146
BXRC-50C10K1-D-74	70	1050	36.5	38.3	7669	7472	200
		1400	37.2	52.1	9869	9185	189
		<b>2100</b>	<b>38.7</b>	<b>81.3</b>	<b>13942</b>	<b>12547</b>	<b>172</b>
		3150	40.6	128.0	19848	16724	155
		4200	42.4	178.0	25015	20427	141
BXRC-50E10K1-B-74	80	900	49.6	44.7	8150	8161	182
		1200	50.5	60.6	10754	10200	178
		<b>1800</b>	<b>52.0</b>	<b>93.6</b>	<b>15553</b>	<b>13998</b>	<b>166</b>
		2700	54.1	146.1	22932	19135	157
		3600	55.8	201.0	29567	23489	147
BXRC-50E10K1-C-74	80	855	66.2	56.6	11191	10650	198
		1140	67.3	76.7	14224	13121	185
		<b>1710</b>	<b>69.4</b>	<b>118.7</b>	<b>19701</b>	<b>17731</b>	<b>166</b>
		2565	72.1	185.0	27948	24038	151
		3420	74.4	254.6	35030	29435	138
BXRC-50E10K1-D-74	80	1050	36.5	38.3	7208	7024	188
		1400	37.2	52.1	9277	8634	178
		<b>2100</b>	<b>38.7</b>	<b>81.3</b>	<b>13105</b>	<b>11795</b>	<b>161</b>
		3150	40.6	128.0	18657	15720	146
		4200	42.4	178.0	23515	19202	132
BXRC-50G10K1-B-74	90	900	49.6	44.7	6936	6945	155
		1200	50.5	60.6	9152	8681	151
		<b>1800</b>	<b>52.0</b>	<b>93.6</b>	<b>13237</b>	<b>11913</b>	<b>141</b>
		2700	54.1	146.1	19517	16285	134
		3600	55.8	201.0	25163	19990	125
BXRC-50G10K1-C-74	90	855	66.2	56.6	9525	9064	168
		1140	67.3	76.7	12106	11167	158
		<b>1710</b>	<b>69.4</b>	<b>118.7</b>	<b>16767</b>	<b>15090</b>	<b>141</b>
		2565	72.1	185.0	23786	20457	129
		3420	74.4	254.6	29813	25051	117
BXRC-50G10K1-D-74	90	1050	36.5	38.3	6135	5978	160
		1400	37.2	52.1	7895	7348	151
		<b>2100</b>	<b>38.7</b>	<b>81.3</b>	<b>11153</b>	<b>10038</b>	<b>137</b>
		3150	40.6	128.0	15878	13379	124
		4200	42.4	178.0	20012	16342	112

Notes for Table 3:

1. Alternate drive currents in Table 3 are provided for reference only and are not a guarantee of performance.
2. Bridgelux maintains a  $\pm 7\%$  tolerance on flux measurements.
3. Typical stabilized DC performance values are provided as reference only and are not a guarantee of performance.



# Performance at Commonly Used Drive Currents

**Table 3:** Product Performance at Commonly Used Drive Currents (Continued)

Part Number	CRI	Drive Current <sup>1</sup> (mA)	Typical V <sub>f</sub> T <sub>c</sub> = 25°C (V)	Typical Power T <sub>c</sub> = 25°C (W)	Typical Flux <sup>2</sup> T <sub>c</sub> = 25°C (lm)	Typical DC Flux <sup>3</sup> T <sub>c</sub> = 85°C (lm)	Typical Efficacy T <sub>c</sub> = 25°C (lm/W)
BXRC-57C10K1-B-74	70	900	49.6	44.7	8366	8377	187
		1200	50.5	60.6	11039	10470	182
		<b>1800</b>	<b>52.0</b>	<b>93.6</b>	<b>15966</b>	<b>14369</b>	<b>171</b>
		2700	54.1	146.1	23540	19643	161
		3600	55.8	201.0	30351	24111	151
BXRC-57C10K1-C-74	70	855	66.2	56.6	11488	10932	203
		1140	67.3	76.7	14601	13469	190
		<b>1710</b>	<b>69.4</b>	<b>118.7</b>	<b>20223</b>	<b>18201</b>	<b>170</b>
		2565	72.1	185.0	28689	24675	155
		3420	74.4	254.6	35959	30215	141
BXRC-57C10K1-D-74	70	1050	36.5	38.3	7400	7210	193
		1400	37.2	52.1	9523	8862	183
		<b>2100</b>	<b>38.7</b>	<b>81.3</b>	<b>13452</b>	<b>12107</b>	<b>166</b>
		3150	40.6	128.0	19152	16137	150
		4200	42.4	178.0	24138	19711	136
BXRC-57E10K1-B-74	80	900	49.6	44.7	8290	8301	186
		1200	50.5	60.6	10938	10375	181
		<b>1800</b>	<b>52.0</b>	<b>93.6</b>	<b>15820</b>	<b>14238</b>	<b>169</b>
		2700	54.1	146.1	23326	19464	160
		3600	55.8	201.0	30075	23892	150
BXRC-57E10K1-C-74	80	855	66.2	56.6	11384	10833	201
		1140	67.3	76.7	14469	13346	189
		<b>1710</b>	<b>69.4</b>	<b>118.7</b>	<b>20039</b>	<b>18035</b>	<b>169</b>
		2565	72.1	185.0	28428	24450	154
		3420	74.4	254.6	35632	29941	140
BXRC-57E10K1-D-74	80	1050	36.5	38.3	7332	7144	191
		1400	37.2	52.1	9436	8782	181
		<b>2100</b>	<b>38.7</b>	<b>81.3</b>	<b>13330</b>	<b>11997</b>	<b>164</b>
		3150	40.6	128.0	18977	15990	148
		4200	42.4	178.0	23918	19531	134
BXRC-65C10K1-B-74	70	900	49.6	44.7	8518	8529	191
		1200	50.5	60.6	11239	10661	186
		<b>1800</b>	<b>52.0</b>	<b>93.6</b>	<b>16256</b>	<b>14630</b>	<b>174</b>
		2700	54.1	146.1	23968	20000	164
		3600	55.8	201.0	30902	24550	154
BXRC-65C10K1-C-74	70	855	66.2	56.6	11697	11131	207
		1140	67.3	76.7	14867	13714	194
		<b>1710</b>	<b>69.4</b>	<b>118.7</b>	<b>20591</b>	<b>18532</b>	<b>174</b>
		2565	72.1	185.0	29210	25123	158
		3420	74.4	254.6	36612	30765	144
BXRC-65C10K1-D-74	70	1050	36.5	38.3	7534	7341	197
		1400	37.2	52.1	9696	9024	186
		<b>2100</b>	<b>38.7</b>	<b>81.3</b>	<b>13697</b>	<b>12327</b>	<b>169</b>
		3150	40.6	128.0	19500	16430	152
		4200	42.4	178.0	24577	20069	138

Notes for Table 3:

1. Alternate drive currents in Table 3 are provided for reference only and are not a guarantee of performance.
2. Bridgelux maintains a ± 7% tolerance on flux measurements.
3. Typical stabilized DC performance values are provided as reference only and are not a guarantee of performance.

# Performance at Commonly Used Drive Currents

**Table 3:** Product Performance at Commonly Used Drive Currents (Continued)

Part Number	CRI	Drive Current <sup>1</sup> (mA)	Typical $V_f$ $T_c = 25^\circ\text{C}$ (V)	Typical Power $T_c = 25^\circ\text{C}$ (W)	Typical Flux <sup>2</sup> $T_c = 25^\circ\text{C}$ (lm)	Typical DC Flux <sup>3</sup> $T_c = 85^\circ\text{C}$ (lm)	Typical Efficacy $T_c = 25^\circ\text{C}$ (lm/W)
BXRC-65E10K1-B-74	80	900	49.6	44.7	8442	8453	189
		1200	50.5	60.6	11139	10565	184
		<b>1800</b>	<b>52.0</b>	<b>93.6</b>	<b>16111</b>	<b>14500</b>	<b>172</b>
		2700	54.1	146.1	23754	19821	163
BXRC-65E10K1-C-74	80	3600	55.8	201.0	30627	24330	152
		855	66.2	56.6	11593	11031	205
		1140	67.3	76.7	14734	13591	192
		<b>1710</b>	<b>69.4</b>	<b>118.7</b>	<b>20407</b>	<b>18366</b>	<b>172</b>
BXRC-65E10K1-D-74	80	2565	72.1	185.0	28950	24899	156
		3420	74.4	254.6	36286	30490	143
		1050	36.5	38.3	7467	7275	195
		1400	37.2	52.1	9610	8943	184
BXRC-65E10K1-D-74	80	<b>2100</b>	<b>38.7</b>	<b>81.3</b>	<b>13575</b>	<b>12217</b>	<b>167</b>
		3150	40.6	128.0	19326	16284	151
		4200	42.4	178.0	24357	19890	137

Notes for Table 3:

1. Alternate drive currents in Table 3 are provided for reference only and are not a guarantee of performance.
2. Bridgelux maintains a  $\pm 7\%$  tolerance on flux measurements.
3. Typical stabilized DC performance values are provided as reference only and are not a guarantee of performance.

# Electrical Characteristics

**Table 4:** Electrical Characteristics

Part Number	Drive Current (mA)	Forward Voltage Pulsed, $T_c = 25^\circ\text{C}$ (V) <sup>1,2,3</sup>			Typical Coefficient of Forward Voltage <sup>4</sup> $\Delta V_f / \Delta T_c$ (mV/ $^\circ\text{C}$ )	Typical Thermal Resistance Junction to Case <sup>5,6</sup> $R_{j-c}$ ( $^\circ\text{C}/\text{W}$ )	Driver Selection Voltages <sup>7</sup> (V)	
		Minimum	Typical	Maximum			$V_f$ Min. Hot $T_c = 105^\circ\text{C}$ (V)	$V_f$ Max. Cold $T_c = -40^\circ\text{C}$ (V)
BXRC-xxx10Kx-B-7x	1800	48.1	52.0	55.9	-22.1	0.06	46.3	57.3
	3600	51.7	55.8	60.0	-22.1	0.07	49.9	61.5
BXRC-xxx10Kx-C-7x	1710	64.2	69.4	74.6	-17.4	0.04	62.8	75.7
	3420	68.8	74.4	80.0	-22.1	0.05	67.1	81.4
BXRC-xxx10Kx-D-7x	2100	35.8	38.7	41.6	-22.1	0.06	34.0	43.0
	4200	39.2	42.4	45.6	-17.4	0.07	37.8	46.7

Notes for Table 4:

- Parts are tested in pulsed conditions,  $T_c = 25^\circ\text{C}$ . Pulse width is 10ms.
- Voltage minimum and maximum are provided for reference only and are not a guarantee of performance.
- Bridgelux maintains a tester tolerance of  $\pm 0.10\text{V}$  on forward voltage measurements.
- Typical coefficient of forward voltage tolerance is  $\pm 0.1\text{mV}$  for nominal current.
- Thermal resistance values are based from test data of a 3000K 80 CRI product.
- Thermal resistance value was calculated using total electrical input power; optical power was not subtracted from input power. The thermal interface material used during testing is not included in the thermal resistance value.
- $V_f$  min hot and max cold values are provided as reference only and are not guaranteed by test. These values are provided to aid in driver design and selection over the operating range of the product.

# Absolute Maximum Ratings

**Table 5:** Maximum Ratings

Parameter	Maximum Rating		
LED Junction Temperature (T <sub>j</sub> )	125°C		
Storage Temperature	-40°C to +105°C		
Operating Case Temperature <sup>1</sup> (T <sub>c</sub> )	105°C		
Soldering Temperature <sup>2</sup>	350°C or lower for a maximum of 10seconds		
	BXRC-xxx10Kx-B-7x	BXRC-xxx10Kx-C-7x	BXRC-xxx10Kx-D-7x
Maximum Drive Current <sup>3,4</sup>	3600mA	3420mA	4200mA
Maximum Peak Pulsed Drive Current <sup>4,5</sup>	5143mA	4886mA	6000mA
Maximum Reverse Voltage <sup>6</sup>	-90V	-120V	-65V

Notes for Table 5:

1. For IEC 62717 requirement, please consult your Bridgelux sales representative.
2. Refer to Bridgelux Application Note AN31: Assembly Considerations for Bridgelux Vero LED Arrays.
3. Arrays may be driven at higher currents however lumen maintenance may be reduced.
4. Per IEC 62031, LED Modules for General Lighting - Safety Specifications, the maximum allowable current when using the Molex Pico Connector is 3150mA.
5. Bridgelux recommends a maximum duty cycle of 10% and pulse width of 20 ms when operating LED Arrays at maximum peak pulsed current specified. Maximum peak pulsed currents indicate values where LED Arrays can be driven without catastrophic failures.
6. Light emitting diodes are not designed to be driven in reverse voltage and will not produce light under this condition. Maximum rating provided for reference only.

# Performance Curves

Figure 1: Vero 29B Drive Current vs. Voltage ( $T_j = T_c = 25^\circ\text{C}$ )

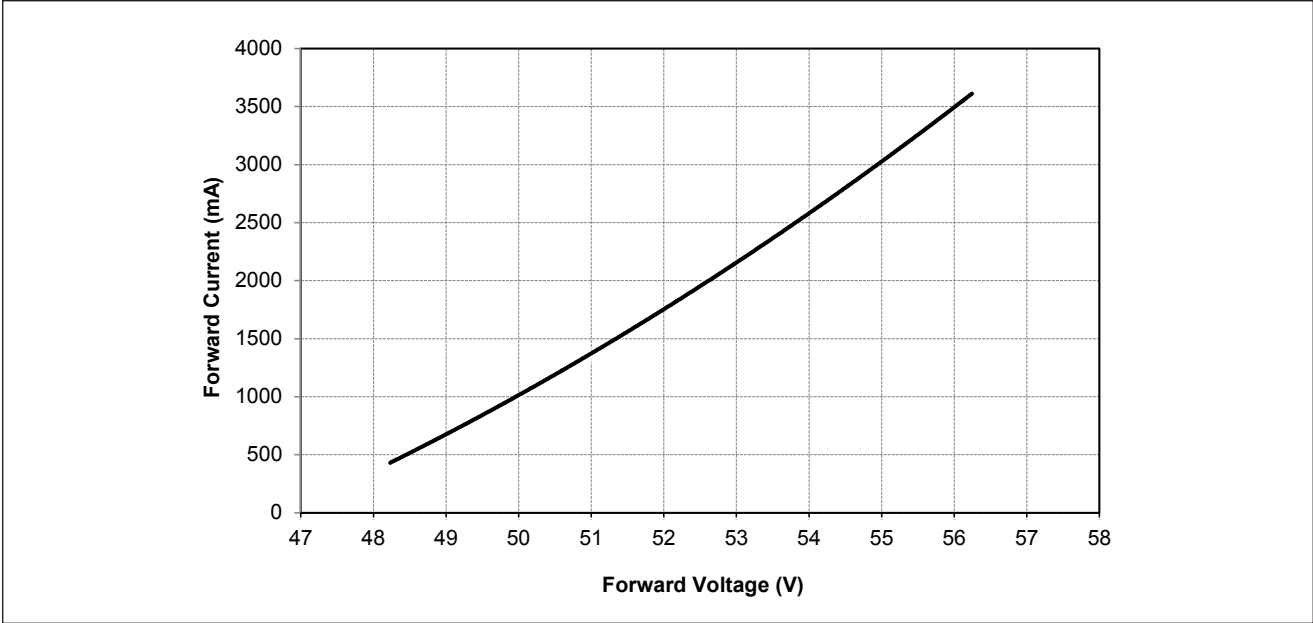
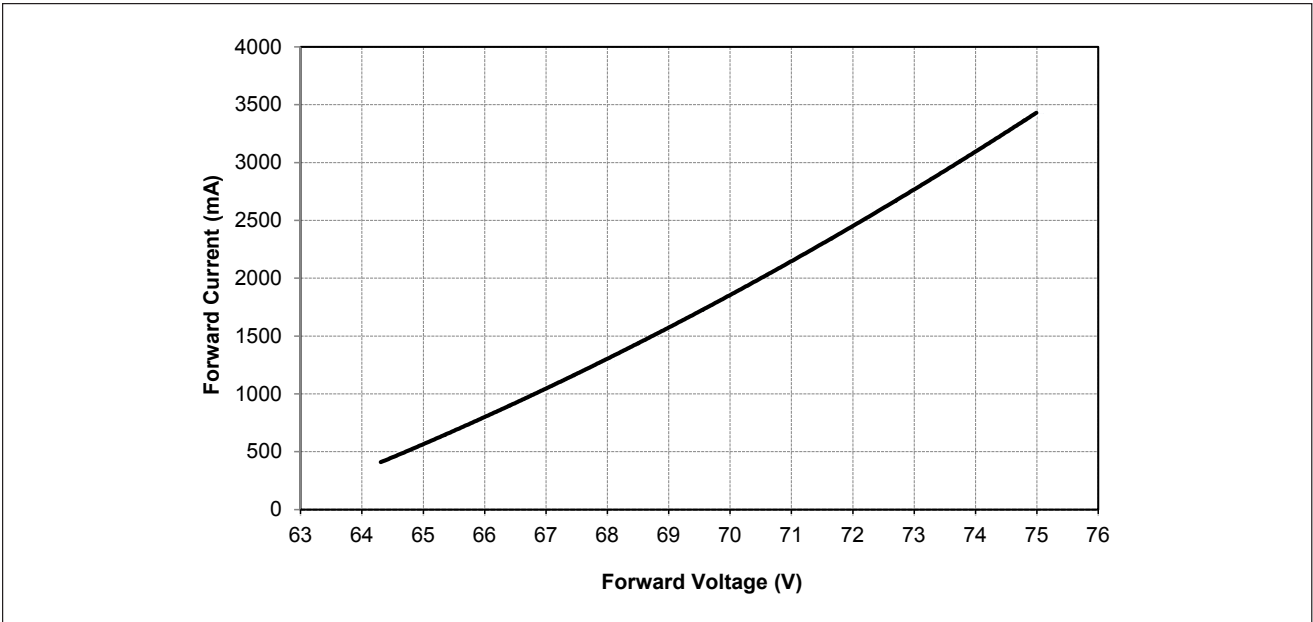

Figure 2: Vero 29C Drive Current vs. Voltage ( $T_j = T_c = 25^\circ\text{C}$ )





# Performance Curves

Figure 3: Vero 29D Drive Current vs. Voltage ( $T_j = T_c = 25^\circ\text{C}$ )

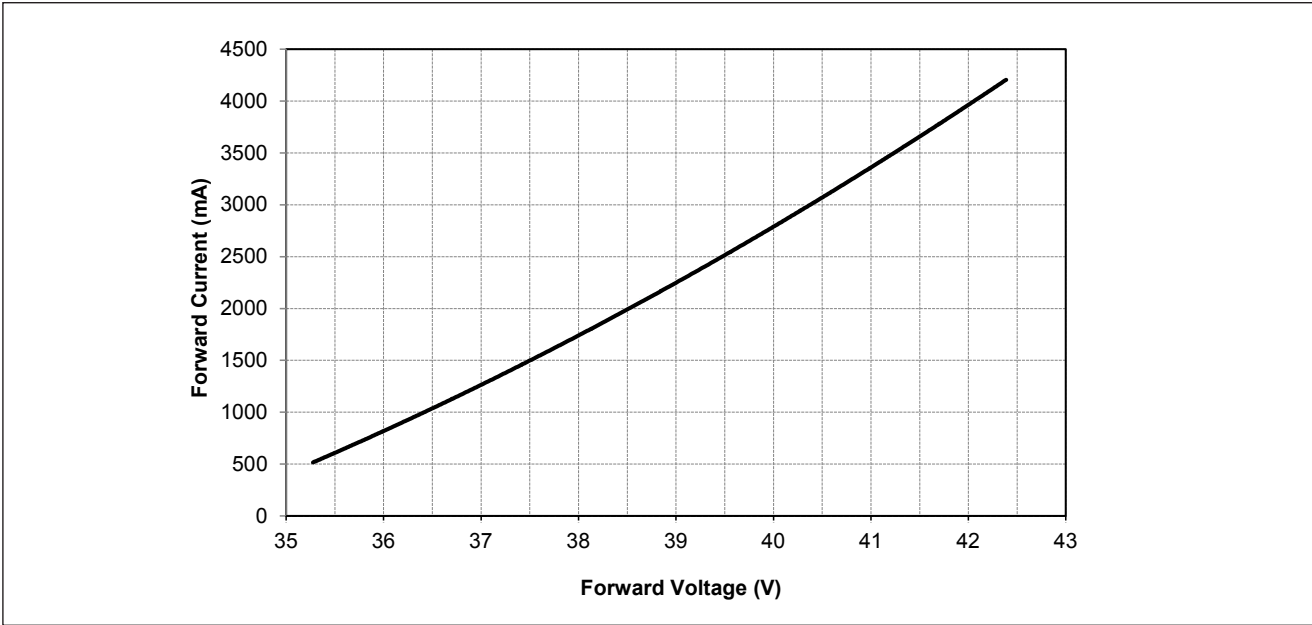
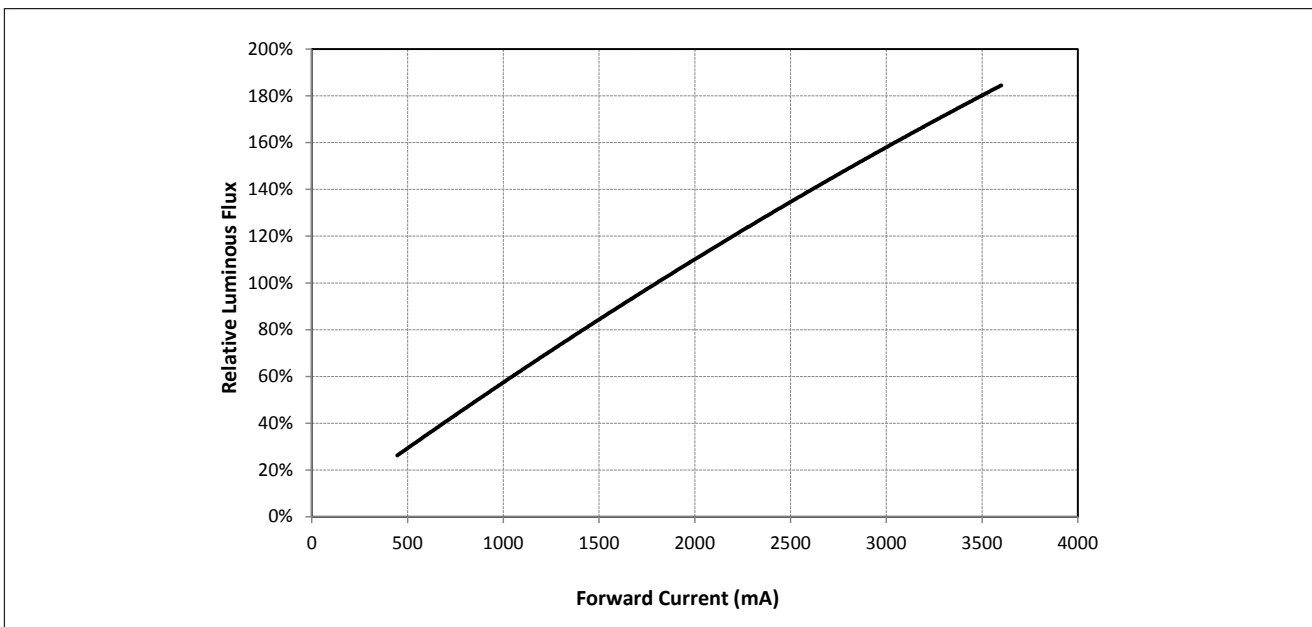

Figure 4: Vero 29B Typical Relative Flux vs. Current ( $T_j = T_c = 25^\circ\text{C}$ )



Note for Figure 4:

1. Bridgelux does not recommend driving high power LEDs at low currents. Doing so may produce unpredictable results. Pulse width modulation (PWM) is recommended for dimming effects.

# Performance Curves

Figure 5: Vero 29C Typical Relative Flux vs. Current ( $T_j = T_c = 25^\circ\text{C}$ )

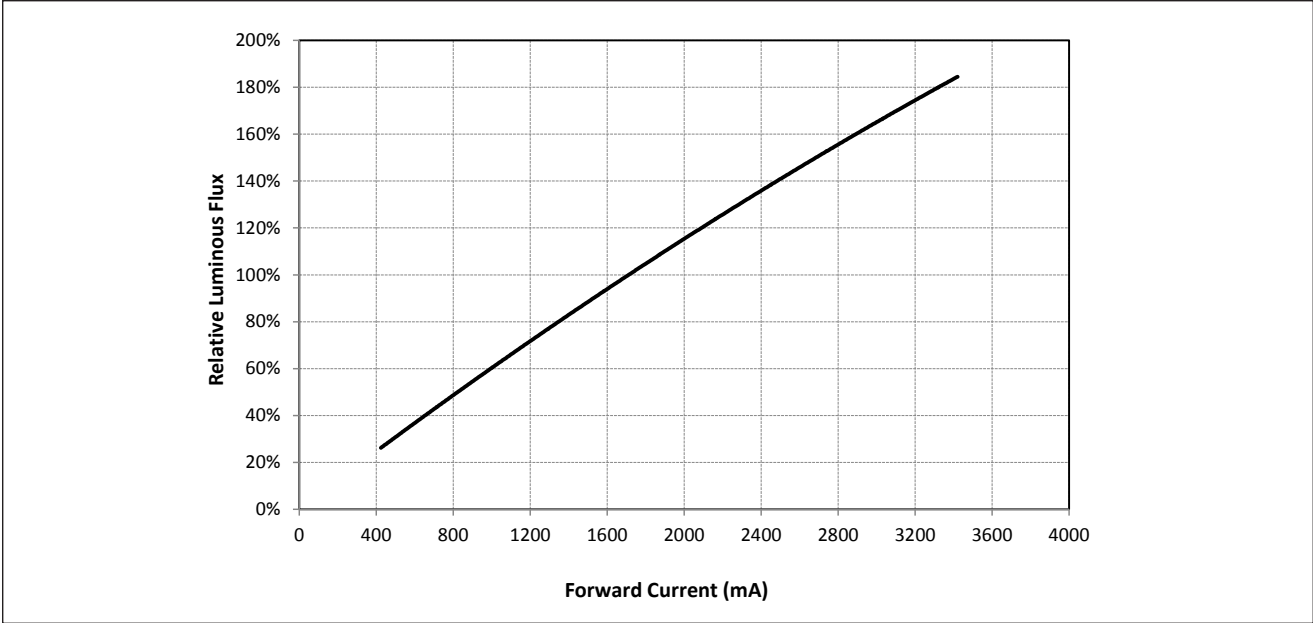
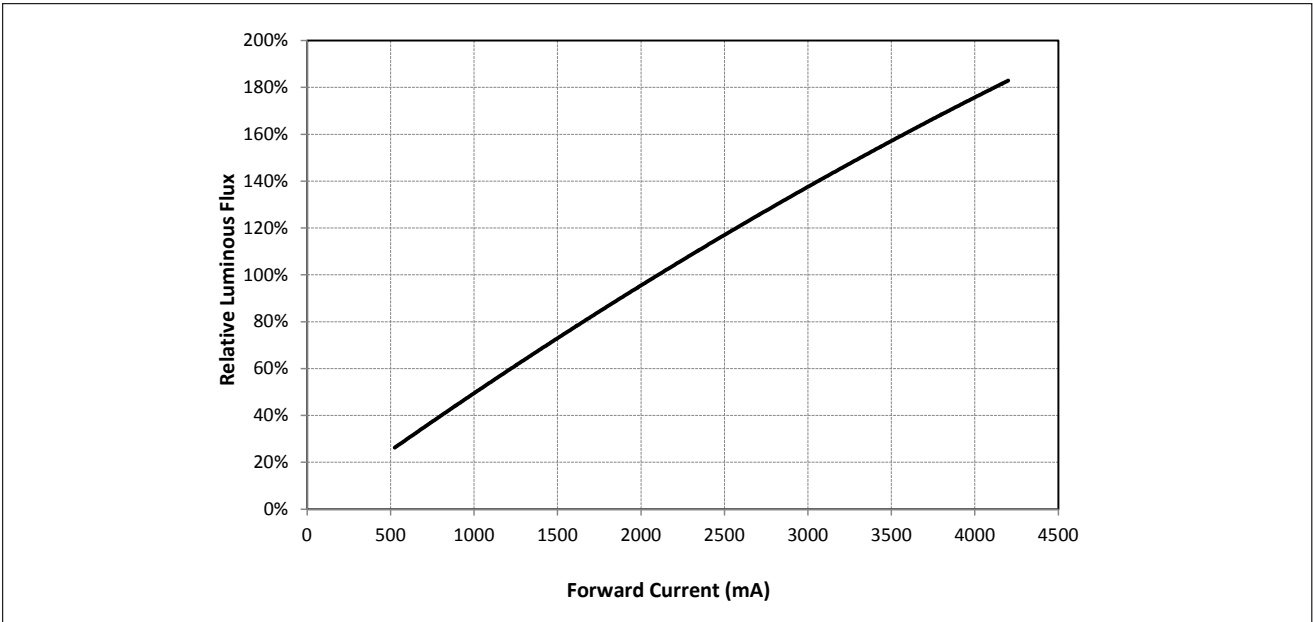

Figure 6 Vero 29D Typical Relative Flux vs. Current ( $T_j = T_c = 25^\circ\text{C}$ )



Note for Figures 5 & 6:

- 1. Bridgelux does not recommend driving high power LEDs at low currents. Doing so may produce unpredictable results. Pulse width modulation (PWM) is recommended for dimming effects.

# Performance Curves

**Figure 7: Typical DC Flux vs. Case Temperature**

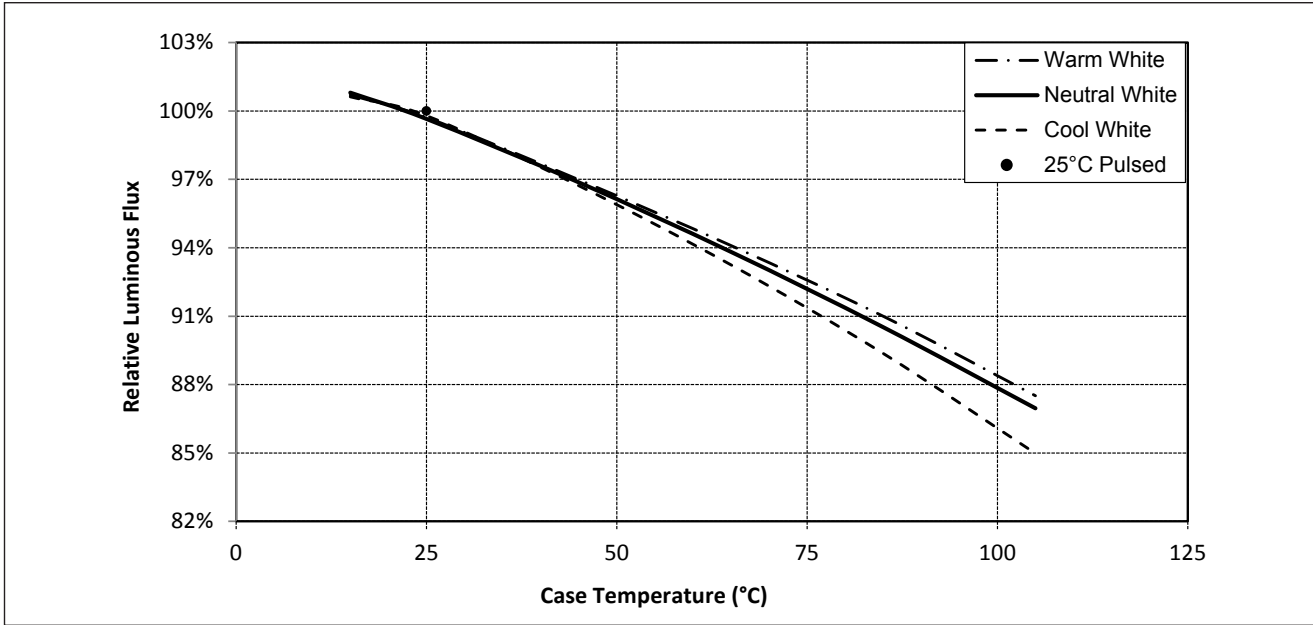

**Figure 8: Typical DC ccy Shift vs. Case Temperature**

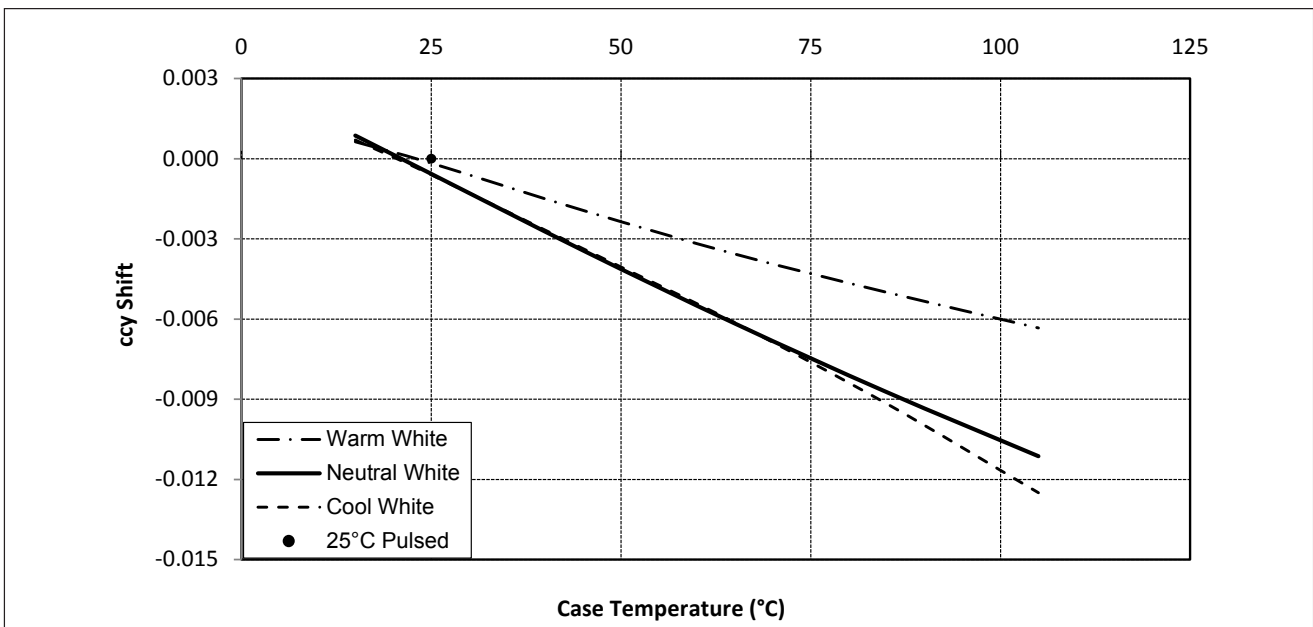

Notes for Figures 7 & 8:

1. Characteristics shown for warm white based on 3000K and 80 CRI.
2. Characteristics shown for neutral white based on 4000K and 80 CRI.
3. Characteristics shown for cool white based on 5000K and 70 CRI.
4. For other color SKUs, the shift in color will vary. Please contact your Bridgelux Sales Representative for more information.

# Performance Curves

Figure 9: Typical DC ccx Shift vs. Case Temperature

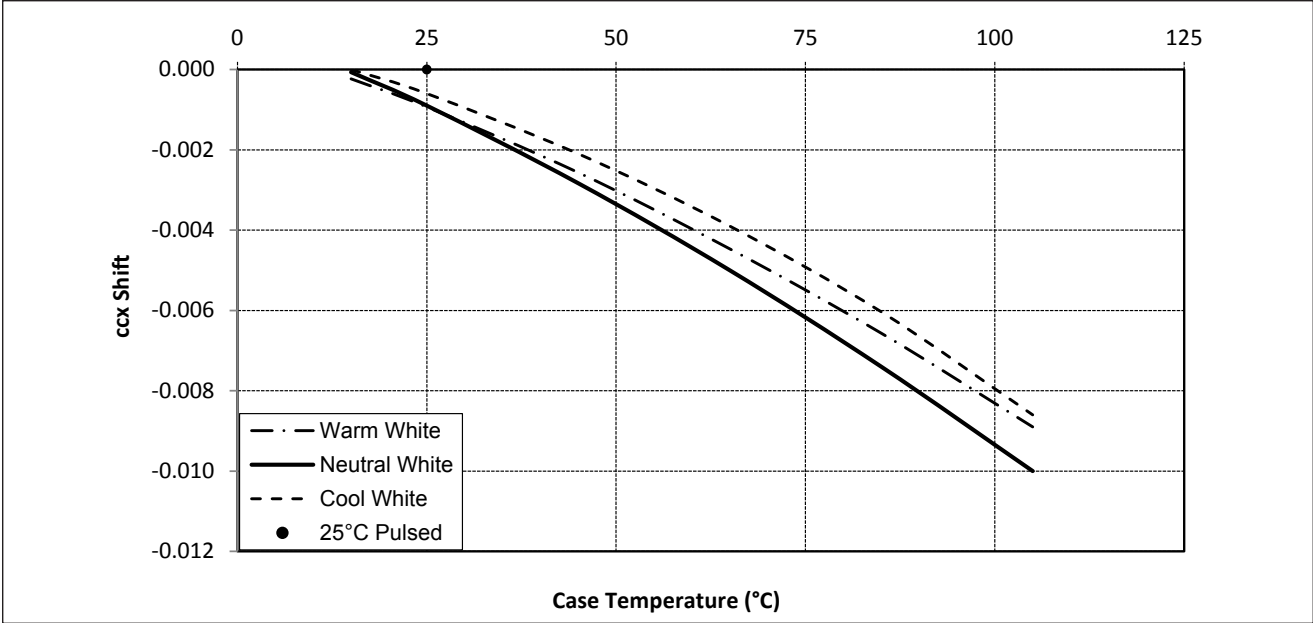

Notes for Figure 9:

- 1. Characteristics shown for warm white based on 3000K and 80 CRI.
- 2. Characteristics shown for neutral white based on 4000K and 80 CRI.
- 3. Characteristics shown for cool white based on 5000K and 70 CRI.
- 4. For other color SKUs, the shift in color will vary. Please contact your Bridgelux Sales Representative for more information.

# Typical Radiation Pattern

Figure 10: Typical Spatial Radiation Pattern

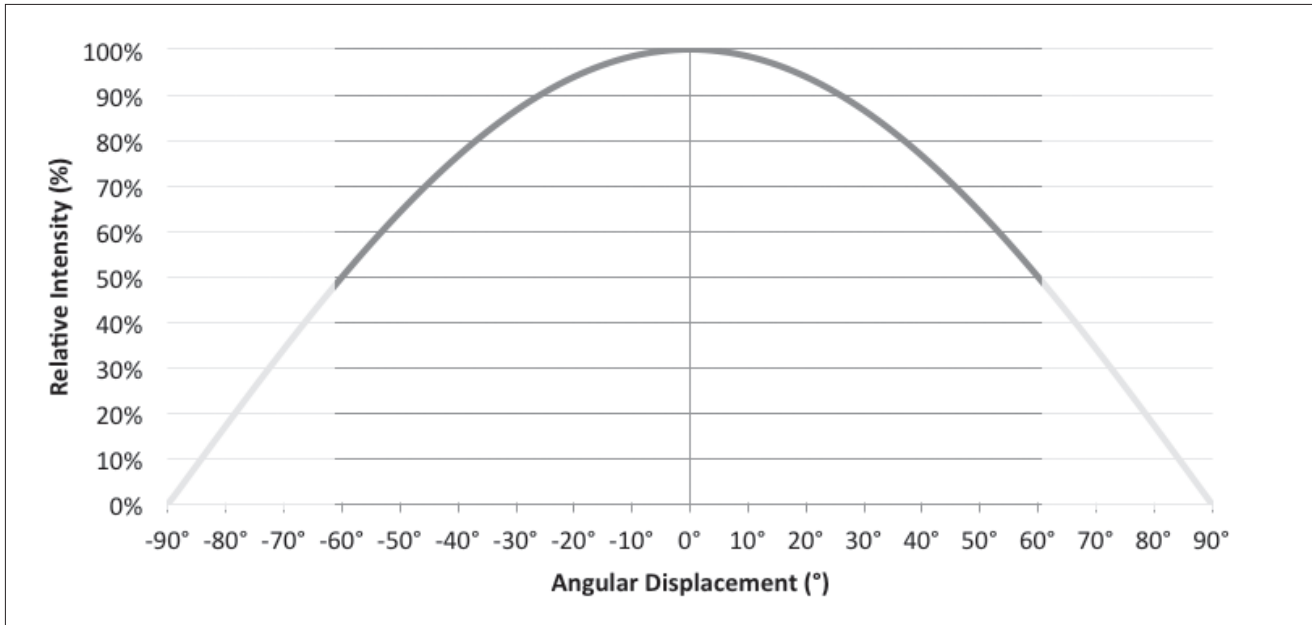

Note for Figure 10:

1. Typical viewing angle is 120°.
2. The viewing angle is defined as the off axis angle from the centerline where intensity is ½ of the peak value.

Figure 11: Typical Polar Radiation Pattern

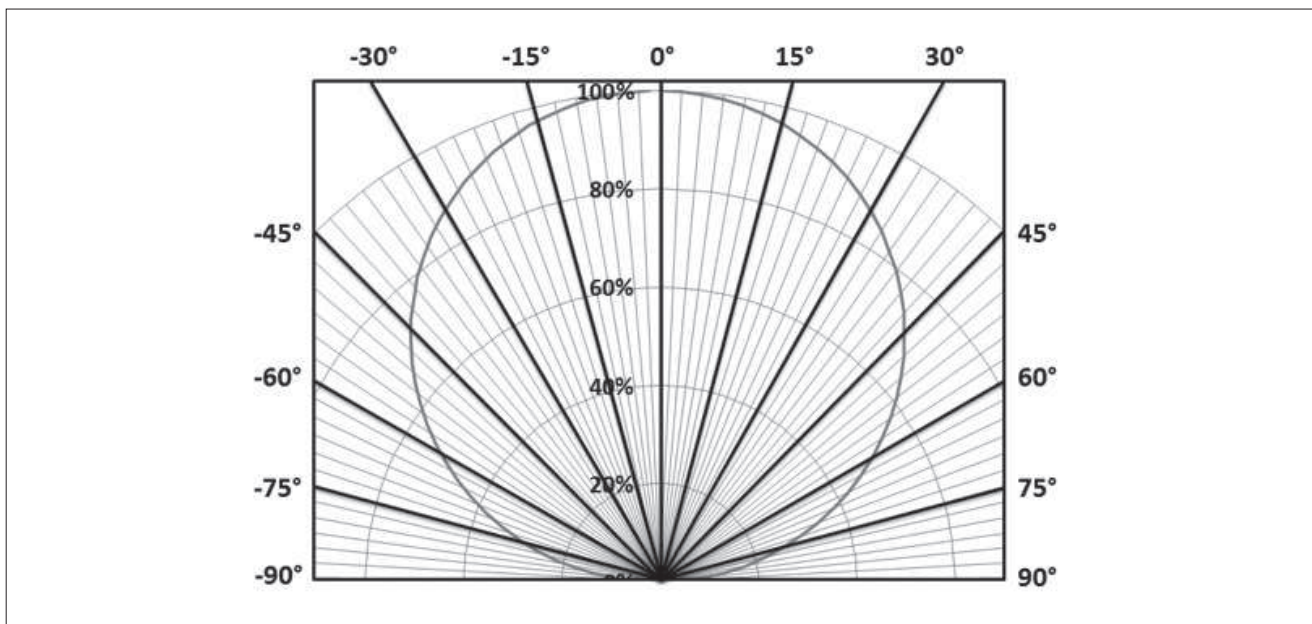



# Typical Color Spectrum

Figure 12: Typical Color Spectrum

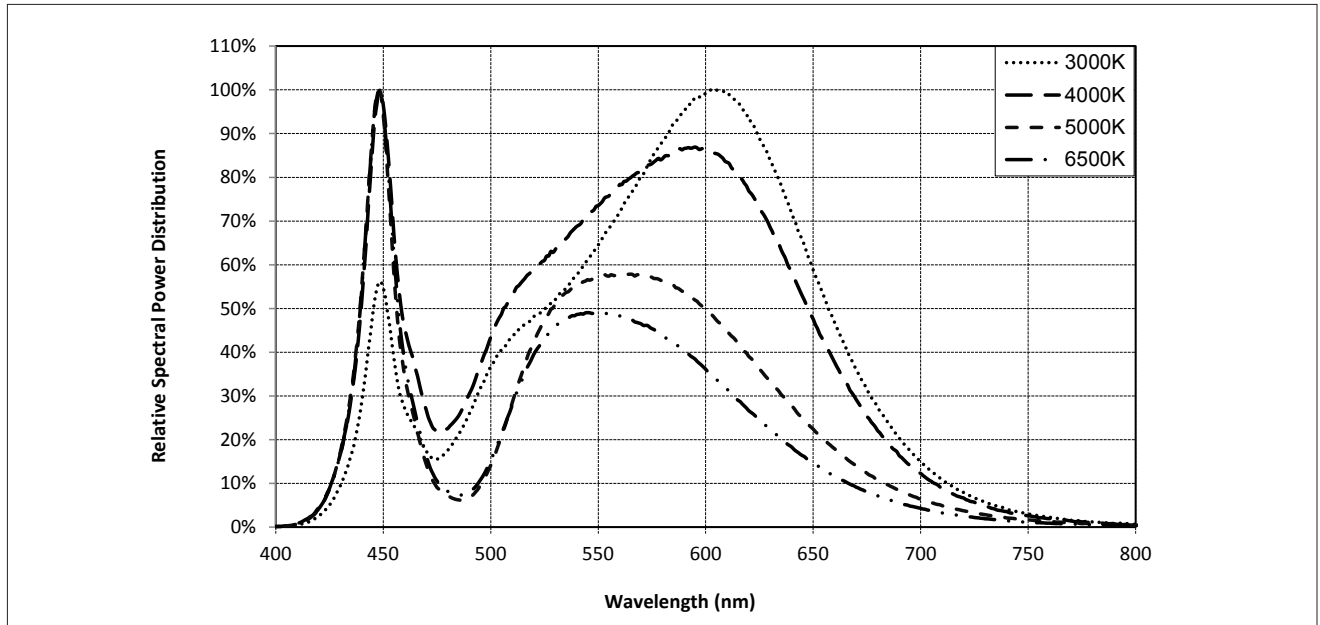

Note for Figure 12:

1. Color spectra measured at nominal current for  $T_j = T_c = 25^\circ\text{C}$ .
2. Color spectra shown is 3000K and 80 CRI.
3. Color spectra shown is 4000K and 80 CRI.
4. Color spectra shown is 5000K and 70 CRI.
4. Color spectra shown is 6500K and 70 CRI.

# Mechanical Dimensions

**Figure 13: Drawing for Vero 29 LED Array**

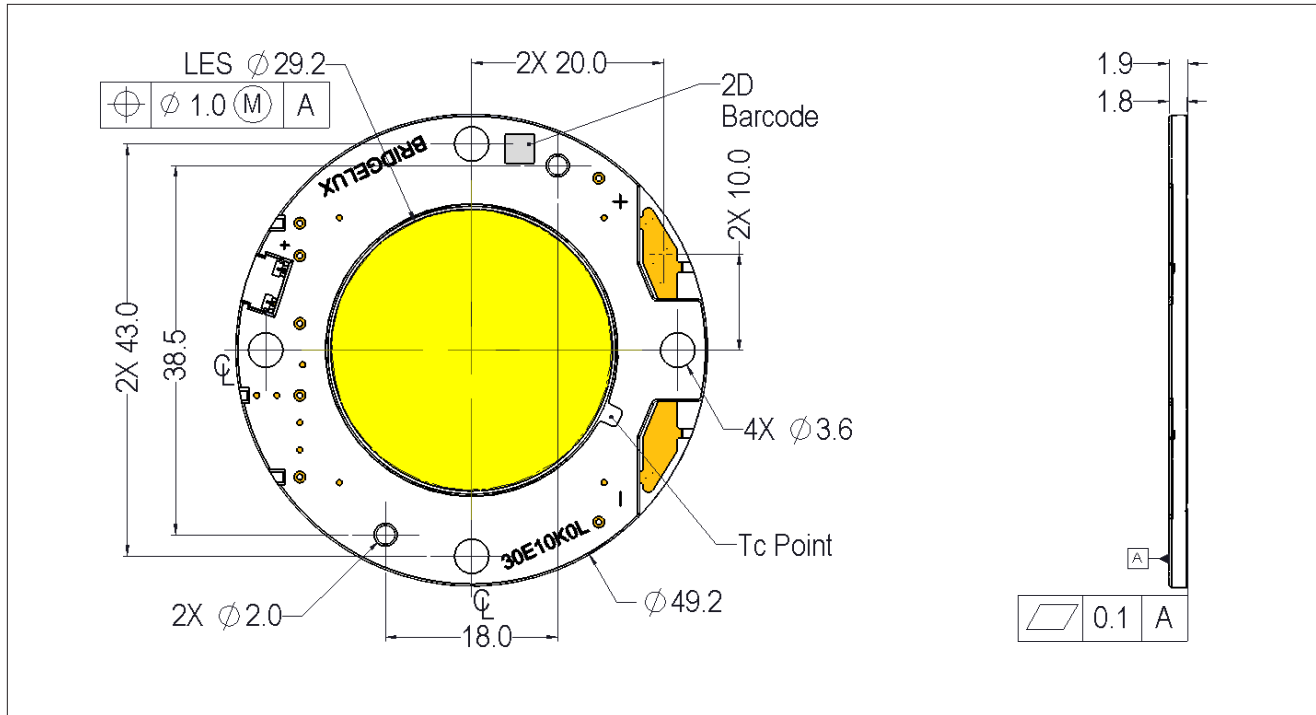

Notes for Figure 10:

1. Drawings are not to scale.
2. Drawing dimensions are in millimeters.
3. Unless otherwise specified, tolerances are  $\pm 0.10\text{mm}$ .
4. Mounting holes (4X) are for M3 screws.
5. Bridgelux recommends four tapped holes for mounting screws with  $43.0 \pm 0.10\text{mm}$  center-to-center spacing.
6. Screws with flat shoulders (pan, dome, button, round, truss, mushroom) provide optimal torque control. Do NOT use flat, countersink, or raised head screws.
7. Solder pads and connector port are labeled "+" and "-" to denote positive and negative, respectively.
8. It is not necessary to provide electrical connections to both the solder pads and the connector port. Either set may be used depending on application specific design requirements.
9. Refer to Application Notes AN30 and AN31 for product handling, mounting and heat sink recommendations.
10. The optical center of the LED Array is nominally defined by the mechanical center of the array to a tolerance of  $\pm 0.2\text{mm}$ .
11. Bridgelux maintains a flatness of  $0.10\text{mm}$  across the mounting surface of the array.

# Color Binning Information

**Figure 14: Graph of Warm and Neutral White Test Bins in xy Color Space**

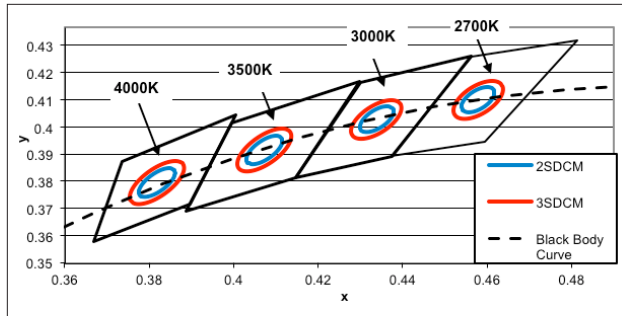

Note: Pulsed Test Conditions,  $T_c = 25^\circ\text{C}$

**Table 6: Warm and Neutral White xy Bin Coordinates and Associated Typical CCT**

Bin Code	2700K	3000K	3500K	4000K
ANSI Bin (for reference only)	(2580K - 2870K)	(2870K - 3220K)	(3220K - 3710K)	(3710K - 4260K)
23 (3 SDCM)	(2651K - 2794K)	(2968K - 3136K)	(3369K - 3586K)	(3851K - 4130K)
22 (2 SDCM)	(2674K - 2769K)	(2995K - 3107K)	(3404K - 3548K)	(3895K - 4081K)
Center Point (x,y)	(0.4578, 0.4101)	(0.4338, 0.403)	(0.4073, 0.3917)	(0.3818, 0.3797)

**Figure 15: Graph of Cool White Test Bins in xy Color Space**

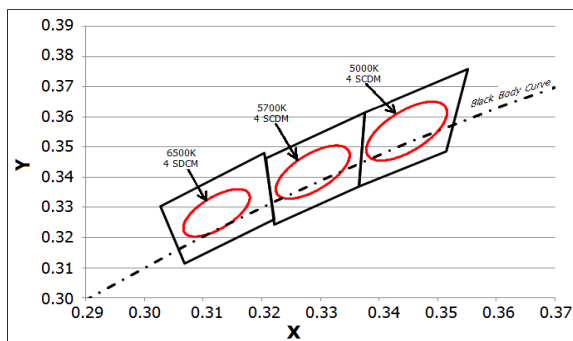

Note: Pulsed Test Conditions,  $T_c = 25^\circ\text{C}$

**Table 7: Cool White xy Bin Coordinates and Associated Typical CCT (product is hot targeted to  $T_c = 85^\circ\text{C}$ )**

Bin Code	5000K	5700K	6500K
ANSI Bin (for reference only)	(4745K - 5311K)	(5312K - 6022K)	(6022K - 7042K)
4 (4 SDCM)	(4801K - 5282K)	(5829K - 5481K)	(6270K - 6765K)
Center Point (x,y)	(0.3447, 0.3553)	(0.3287, 0.3417)	(0.3123, 0.3282)