



Chipsmall Limited consists of a professional team with an average of over 10 year of expertise in the distribution of electronic components. Based in Hongkong, we have already established firm and mutual-benefit business relationships with customers from,Europe,America and south Asia,supplying obsolete and hard-to-find components to meet their specific needs.

With the principle of “Quality Parts,Customers Priority,Honest Operation,and Considerate Service”,our business mainly focus on the distribution of electronic components. Line cards we deal with include Microchip,ALPS,ROHM,Xilinx,Pulse,ON,Everlight and Freescale. Main products comprise IC,Modules,Potentiometer,IC Socket,Relay,Connector.Our parts cover such applications as commercial,industrial, and automotives areas.

We are looking forward to setting up business relationship with you and hope to provide you with the best service and solution. Let us make a better world for our industry!



Contact us

Tel: +86-755-8981 8866 Fax: +86-755-8427 6832

Email & Skype: info@chipsmall.com Web: www.chipsmall.com

Address: A1208, Overseas Decoration Building, #122 Zhenhua RD., Futian, Shenzhen, China



**Damper diode
fast, high-voltage**

BY329X-1500, BY329X-1500S

FEATURES

- Low forward volt drop
- Fast switching
- Soft recovery characteristic
- High thermal cycling performance
- Isolated mounting tab

SYMBOL

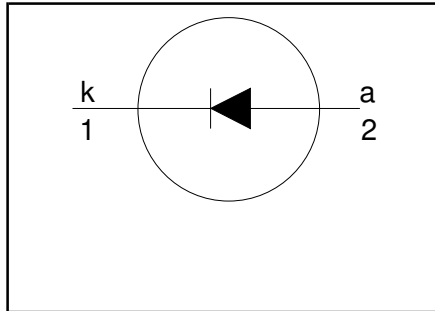

QUICK REFERENCE DATA

$V_R = 1500\text{ V}$
$V_F \leq 1.35\text{ V} / 1.5\text{ V}$
$I_{F(\text{peak})} = 6\text{ A}$ (f = 16 kHz)
$I_{F(\text{peak})} = 6\text{ A}$ (f = 70 kHz)
$I_{FSM} \leq 75\text{ A}$
$t_{tr} \leq 230\text{ ns} / 160\text{ ns}$

GENERAL DESCRIPTION

Glass-passivated double diffused rectifier diode featuring low forward voltage drop, fast reverse recovery and soft recovery characteristic. The device is intended for use in TV receivers and PC monitors.

The BY329X series is supplied in the conventional leaded SOD113 package.

PINNING

PIN	DESCRIPTION
1	anode
2	cathode
tab	isolated

SOD113

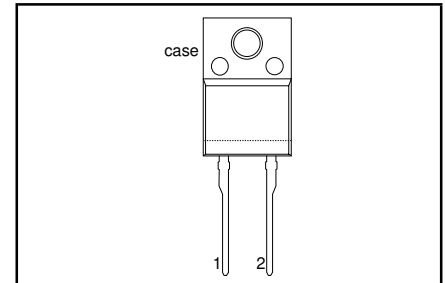

LIMITING VALUES

Limiting values in accordance with the Absolute Maximum System (IEC 134).

SYMBOL	PARAMETER	CONDITIONS	MIN.	MAX.	UNIT
V_{RSM}	Peak non-repetitive reverse voltage		-	1500	V
V_{RRM}	Peak repetitive reverse voltage		-	1500	V
V_{RWM}	Crest working reverse voltage		-	1300	V
$I_{F(\text{peak})}$	Peak working forward current	f = 16 kHz	-	-1500	A
		f = 70 kHz	-	-1500S	
I_{FRM}	Peak repetitive forward current	t = 25 μs; δ = 0.5; T _{hs} ≤ 86 °C	-	14	A
$I_{F(\text{RMS})}$	RMS forward current		-	11	A
I_{FSM}	Peak non-repetitive forward current	t = 10 ms sinusoidal; T _j = 150 °C prior to surge; with reapplied V _{RWM(max)}	-	75	A
T _{stg}	Storage temperature		-40	150	°C
T _j	Operating junction temperature		-	150	°C

Damper diode fast, high-voltage

BY329X-1500, BY329X-1500S

ISOLATION LIMITING VALUE & CHARACTERISTIC

 $T_{hs} = 25\text{ }^{\circ}\text{C}$ unless otherwise specified

SYMBOL	PARAMETER	CONDITIONS	MIN.	TYP.	MAX.	UNIT
V_{isol}	R.M.S. isolation voltage from both terminals to external heatsink	$f = 50\text{-}60\text{ Hz}$; sinusoidal waveform; $R.H. \leq 65\%$; clean and dustfree	-		2500	V
C_{isol}	Capacitance from both terminals to external heatsink	$f = 1\text{ MHz}$	-	10	-	pF

THERMAL RESISTANCES

SYMBOL	PARAMETER	CONDITIONS	MIN.	TYP.	MAX.	UNIT
$R_{th\ j\text{-}hs}$	Thermal resistance junction to heatsink	with heatsink compound	-	-	4.8	K/W
$R_{th\ j\text{-}a}$	Thermal resistance junction to ambient	without heatsink compound in free air.	-	55	5.9	K/W

STATIC CHARACTERISTICS

 $T_j = 25\text{ }^{\circ}\text{C}$ unless otherwise stated

SYMBOL	PARAMETER	CONDITIONS	TYP.		MAX.		UNIT
			1500	1500S	1500	1500S	
V_F	Forward voltage	BY329X- $I_F = 6.5\text{ A}$	1.1	1.3	1.45	1.6	V
I_R	Reverse current	$I_F = 6.5\text{ A}; T_j = 125\text{ }^{\circ}\text{C}$ $V_R = 1300\text{ V}$ $V_R = 1300\text{ V}; T_j = 125\text{ }^{\circ}\text{C}$	1.05	1.2	1.35	1.5	V
			-	250	-	250	μA
			-	1	-	1	mA

DYNAMIC CHARACTERISTICS

 $T_j = 25\text{ }^{\circ}\text{C}$ unless otherwise stated

SYMBOL	PARAMETER	CONDITIONS	TYP.		MAX.		UNIT
			1500	1500S	1500	1500S	
t_{rr}	Reverse recovery time	BY329X $I_F = 1\text{ A}; V_R \geq 30\text{ V};$ $di_F/dt = 50\text{ A}/\mu\text{s}$	0.18	0.13	0.23	0.16	μs
Q_s	Reverse recovery charge	$I_F = 2\text{ A}; -di_F/dt = 20\text{ A}/\mu\text{s}$	1.6	0.7	2.0	0.95	μC
V_{fr}	Peak forward recovery voltage	$I_F = 6.5\text{ A}; di_F/dt = 50\text{ A}/\mu\text{s}$	17	23	30	40	V
t_{fr}	Forward recovery time	$I_F = 6.5\text{ A}; di_F/dt = 50\text{ A}/\mu\text{s}$	210	220	300	320	ns

Damper diode
fast, high-voltage

BY329X-1500, BY329X-1500S

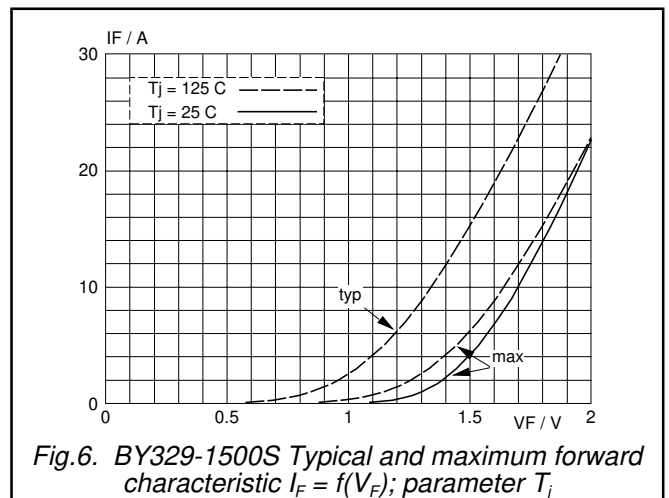
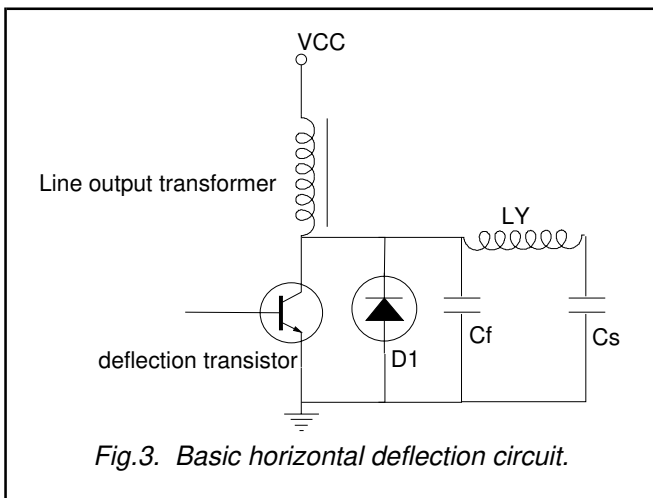
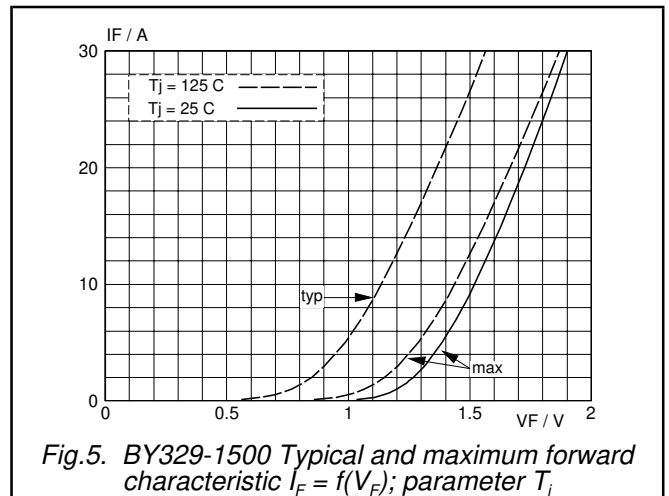
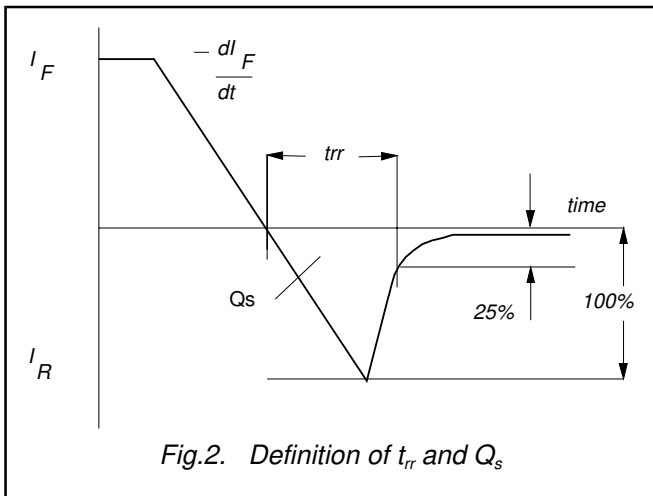
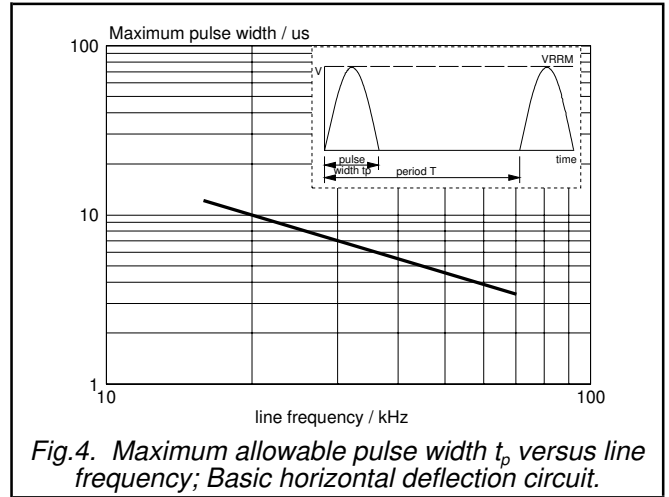
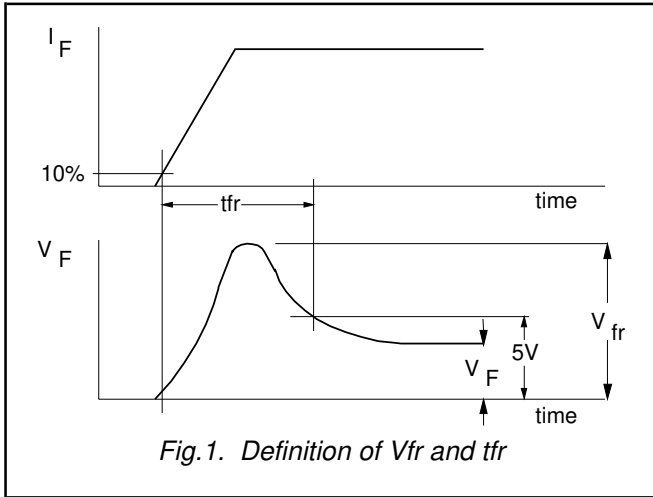

Damper diode
fast, high-voltage

BY329X-1500, BY329X-1500S

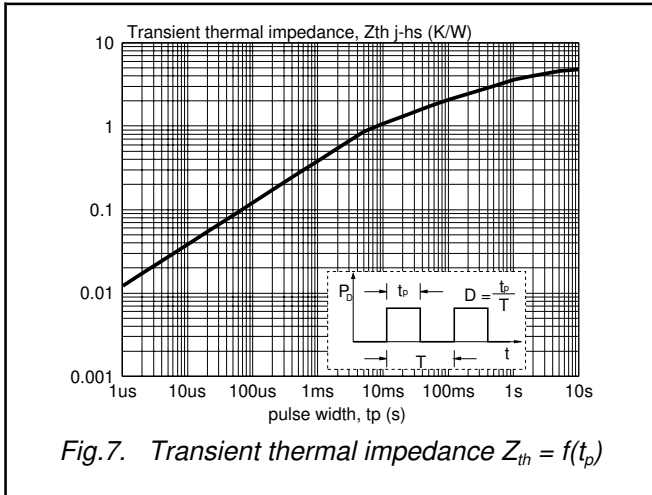
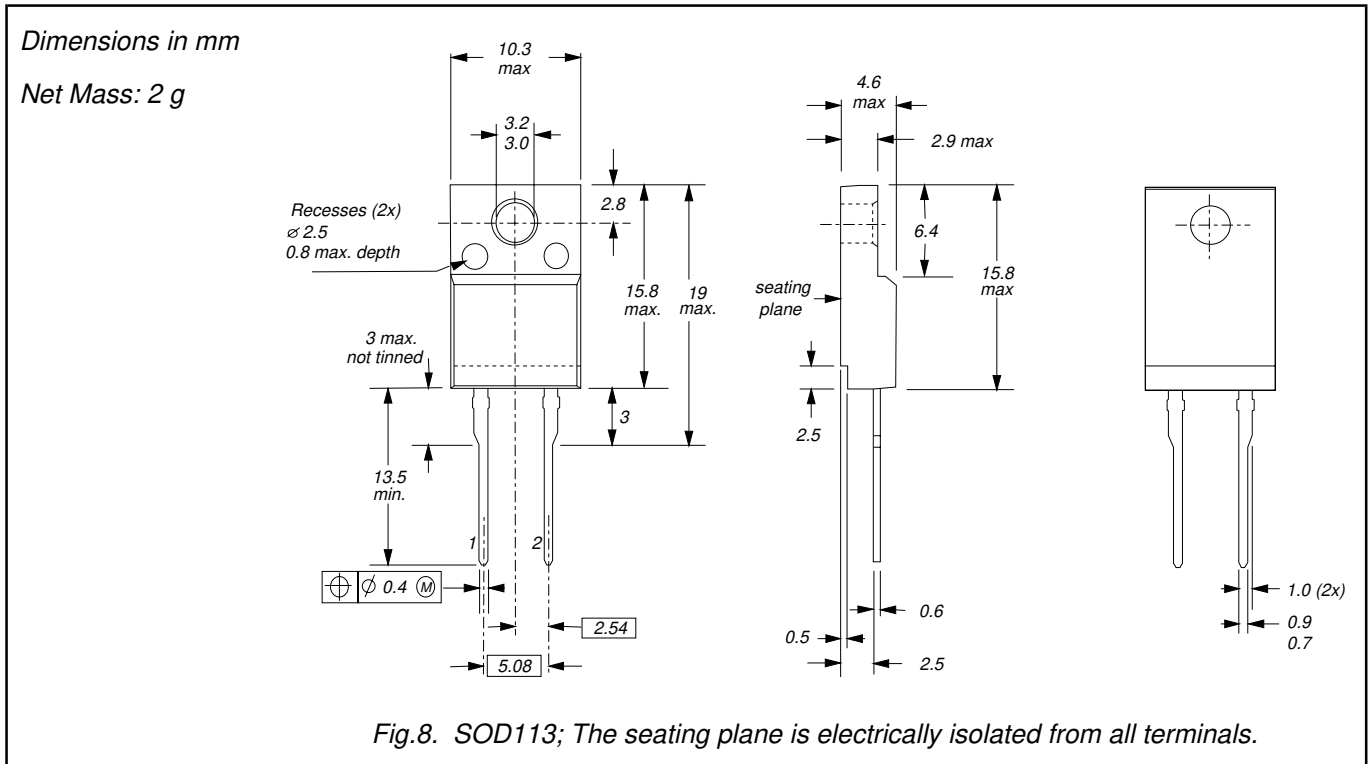

Fig.7. Transient thermal impedance $Z_{th} = f(t_p)$

Damper diode
fast, high-voltage

BY329X-1500, BY329X-1500S

MECHANICAL DATA



Notes

1. Refer to mounting instructions for F-pack envelopes.
2. Epoxy meets UL94 V0 at 1/8".

Damper diode
fast, high-voltage

BY329X-1500, BY329X-1500S

DEFINITIONS

Data sheet status	
Objective specification	This data sheet contains target or goal specifications for product development.
Preliminary specification	This data sheet contains preliminary data; supplementary data may be published later.
Product specification	This data sheet contains final product specifications.
Limiting values	
Limiting values are given in accordance with the Absolute Maximum Rating System (IEC 134). Stress above one or more of the limiting values may cause permanent damage to the device. These are stress ratings only and operation of the device at these or at any other conditions above those given in the Characteristics sections of this specification is not implied. Exposure to limiting values for extended periods may affect device reliability.	
Application information	
Where application information is given, it is advisory and does not form part of the specification.	
© Philips Electronics N.V. 1998	
All rights are reserved. Reproduction in whole or in part is prohibited without the prior written consent of the copyright owner.	
The information presented in this document does not form part of any quotation or contract, it is believed to be accurate and reliable and may be changed without notice. No liability will be accepted by the publisher for any consequence of its use. Publication thereof does not convey nor imply any license under patent or other industrial or intellectual property rights.	

LIFE SUPPORT APPLICATIONS

These products are not designed for use in life support appliances, devices or systems where malfunction of these products can be reasonably expected to result in personal injury. Philips customers using or selling these products for use in such applications do so at their own risk and agree to fully indemnify Philips for any damages resulting from such improper use or sale.