



Chipsmall Limited consists of a professional team with an average of over 10 year of expertise in the distribution of electronic components. Based in Hongkong, we have already established firm and mutual-benefit business relationships with customers from,Europe,America and south Asia,supplying obsolete and hard-to-find components to meet their specific needs.

With the principle of “Quality Parts,Customers Priority,Honest Operation,and Considerate Service”,our business mainly focus on the distribution of electronic components. Line cards we deal with include Microchip,ALPS,ROHM,Xilinx,Pulse,ON,Everlight and Freescale. Main products comprise IC,Modules,Potentiometer,IC Socket,Relay,Connector.Our parts cover such applications as commercial,industrial, and automotives areas.

We are looking forward to setting up business relationship with you and hope to provide you with the best service and solution. Let us make a better world for our industry!



## Contact us

Tel: +86-755-8981 8866 Fax: +86-755-8427 6832

Email & Skype: info@chipsmall.com Web: www.chipsmall.com

Address: A1208, Overseas Decoration Building, #122 Zhenhua RD., Futian, Shenzhen, China





# IMPORTANT NOTICE

10 December 2015

## 1. Global joint venture starts operations as WeEn Semiconductors

Dear customer,

As from November 9th, 2015 NXP Semiconductors N.V. and Beijing JianGuang Asset Management Co. Ltd established Bipolar Power joint venture (JV), **WeEn Semiconductors**, which will be used in future Bipolar Power documents together with new contact details.

In this document where the previous NXP references remain, please use the new links as shown below.

**WWW** - For [www.nxp.com](http://www.nxp.com) use [www.ween-semi.com](http://www.ween-semi.com)

**Email** - For [salesaddresses@nxp.com](mailto:salesaddresses@nxp.com) use [salesaddresses@ween-semi.com](mailto:salesaddresses@ween-semi.com)

For the copyright notice at the bottom of each page (or elsewhere in the document, depending on the version) “© **NXP Semiconductors N.V. {year}. All rights reserved**” becomes “© **WeEn Semiconductors Co., Ltd. {year}. All rights reserved**”

If you have any questions related to this document, please contact our nearest sales office via e-mail or phone (details via [salesaddresses@ween-semi.com](mailto:salesaddresses@ween-semi.com)).

Thank you for your cooperation and understanding,

WeEn Semiconductors



# BYQ28 series E and ED

Rectifier diodes ultrafast, rugged

Rev. 04 — 5 December 2007

Product data sheet

## 1. Product profile

### 1.1 General description

Ultrafast, dual common cathode, epitaxial rectifier diodes in a SOT78 (TO-220AB) and a SOT428 (DPAK) plastic package.

### 1.2 Features

- Fast switching
- Soft recovery characteristic
- Reverse surge capability
- Low thermal resistance
- Low forward voltage drop
- High thermal cycling performance

### 1.3 Applications

- Output rectifiers in high-frequency switched-mode power supplies

### 1.4 Quick reference data

- $V_{RRM} \leq 200$  V
- $V_F \leq 0.895$  V
- $I_{O(AV)} \leq 10$  A
- $t_{rr} = 10$  ns (typ)

## 2. Pinning information

Table 1. Pinning

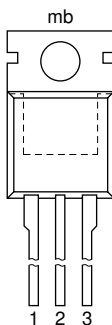
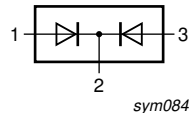
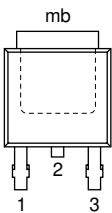
Pin	Description	Simplified outline	Symbol
1	anode 1		
2	cathode <a href="#">[1]</a>		
3	anode 2		
mb	mounting base; cathode	 SOT428 (DPAK)	

[1] It is not possible to connect to pin 2 of the SOT428 package.

### 3. Ordering information

**Table 2. Ordering information**

Type number	Package		Version
	Name	Description	
BYQ28E-200	TO-220AB	plastic single-ended package; heatsink mounted; 1 mounting hole; 3-lead TO-220AB	SOT78
BYQ28ED-200	DPAK	plastic single-ended surface-mounted package (DPAK); 3-leads (one lead cropped)	SOT428

### 4. Limiting values

**Table 3. Limiting values**

*In accordance with the Absolute Maximum Rating System (IEC 60134).*

Symbol	Parameter	Conditions	Min	Max	Unit
$V_{RRM}$	repetitive peak reverse voltage		-	200	V
$V_{RWM}$	crest working reverse voltage		-	200	V
$V_R$	reverse voltage	square waveform; $\delta = 1.0$	-	200	V
$I_{O(AV)}$	average output current	square waveform; $\delta = 0.5$ ; $T_{mb} \leq 119\text{ }^\circ\text{C}$ ; both diodes conducting	-	10	A
$I_{FRM}$	repetitive peak forward current	$t_p = 25\text{ }\mu\text{s}$ ; square waveform; $\delta = 0.5$ ; $T_{mb} \leq 119\text{ }^\circ\text{C}$ ; per diode	-	10	A
$I_{FSM}$	non-repetitive peak forward current	$t = 10\text{ ms}$ ; sinusoidal waveform; per diode	-	50	A
		$t = 8.3\text{ ms}$ ; sinusoidal waveform; per diode	-	55	A
$I_{RM}$	peak reverse recovery current	$t_p = 2\text{ }\mu\text{s}$ ; $\delta = 0.001$	-	0.2	A
$I_{RSM}$	non-repetitive peak reverse current	$t_p = 100\text{ }\mu\text{s}$	-	0.2	A
$T_{stg}$	storage temperature		-40	+150	$^\circ\text{C}$
$T_j$	junction temperature		-	150	$^\circ\text{C}$
<b>Electrostatic discharge</b>					
$V_{ESD}$	electrostatic discharge voltage	all pins; human body model; $C = 250\text{ pF}$ ; $R = 1.5\text{ k}\Omega$	-	8	kV

### 5. Thermal characteristics

**Table 4. Thermal characteristics**

Symbol	Parameter	Conditions	Min	Typ	Max	Unit
$R_{th(j-mb)}$	thermal resistance from junction to mounting base	with heatsink compound; per diode; see <a href="#">Figure 1</a>	-	-	4.5	K/W
		with heatsink compound; both diodes conducting	-	-	3	K/W
$R_{th(j-a)}$	thermal resistance from junction to ambient	in free air; SOT78	-	60	-	K/W
		SOT428	[1]	50	-	K/W

[1] Device mounted on an FR4 Printed-Circuit Board (PCB), single-sided copper, tin-plated and standard footprint.

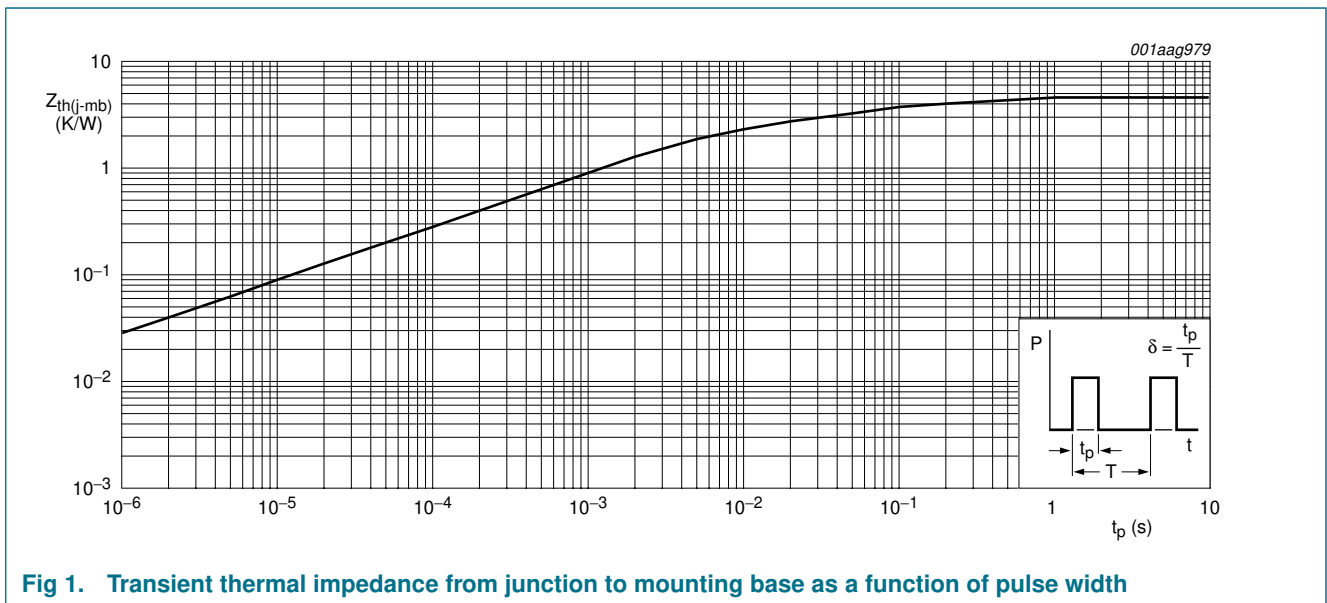

**6. Characteristics**

**Table 5. Characteristics**

*T<sub>j</sub> = 25 °C unless otherwise specified.*

Symbol	Parameter	Conditions	Min	Typ	Max	Unit
<b>Static characteristics</b>						
V <sub>F</sub>	forward voltage	I <sub>F</sub> = 5 A; T <sub>j</sub> = 150 °C; see <a href="#">Figure 2</a>	-	0.8	0.895	V
		I <sub>F</sub> = 5 A; see <a href="#">Figure 2</a>	-	0.95	1.1	V
		I <sub>F</sub> = 10 A; see <a href="#">Figure 2</a>	-	1.1	1.25	V
I <sub>R</sub>	reverse current	V <sub>R</sub> = 200 V	-	2	10	μA
		V <sub>R</sub> = 200 V; T <sub>j</sub> = 100 °C	-	0.1	0.2	mA
<b>Dynamic characteristics</b>						
Q <sub>r</sub>	recovered charge	I <sub>F</sub> = 2 A to V <sub>R</sub> ≥ 30 V; dI <sub>F</sub> /dt = 20 A/μs; see <a href="#">Figure 3</a>	-	4	9	nC
t <sub>rr</sub>	reverse recovery time	ramp recovery; I <sub>F</sub> = 1 A to V <sub>R</sub> ≥ 30 V; dI <sub>F</sub> /dt = 100 A/μs; see <a href="#">Figure 3</a>	-	15	25	ns
		step recovery; when switched from I <sub>F</sub> = 0.5 A to I <sub>R</sub> = 1 A; measured at I <sub>R</sub> = 0.25 A	-	10	20	ns
I <sub>RM</sub>	peak reverse recovery current	I <sub>F</sub> = 5 A to V <sub>R</sub> ≥ 30 V; dI <sub>F</sub> /dt = 50 A/μs; see <a href="#">Figure 3</a>	-	0.5	0.7	A
V <sub>FR</sub>	forward recovery voltage	I <sub>F</sub> = 1 A; dI <sub>F</sub> /dt = 10 A/μs; see <a href="#">Figure 4</a>	-	1	-	V

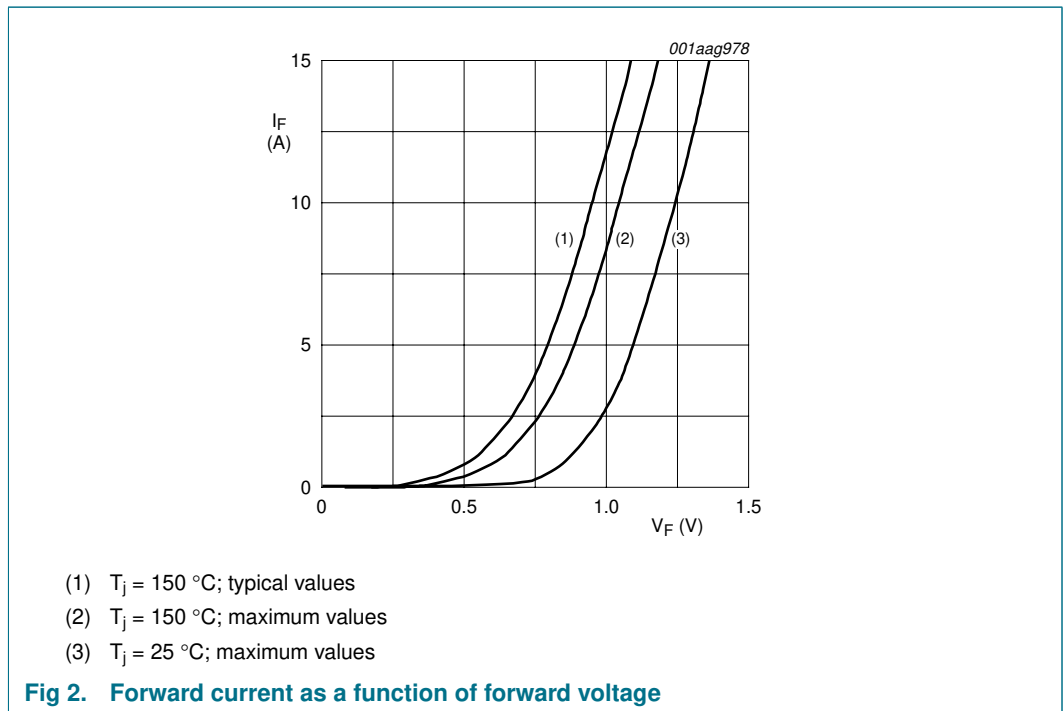

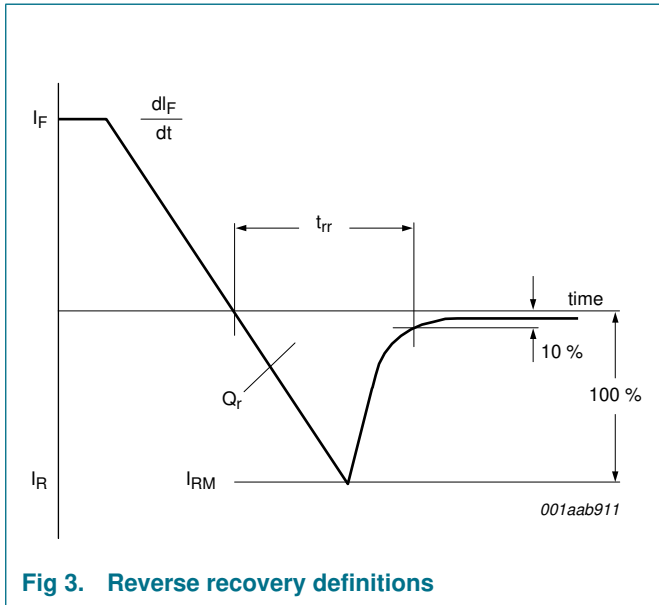

Fig 3. Reverse recovery definitions

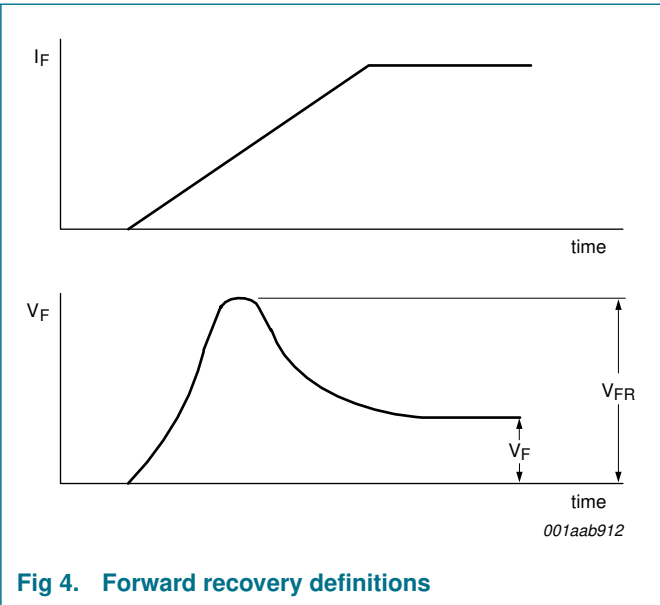

Fig 4. Forward recovery definitions

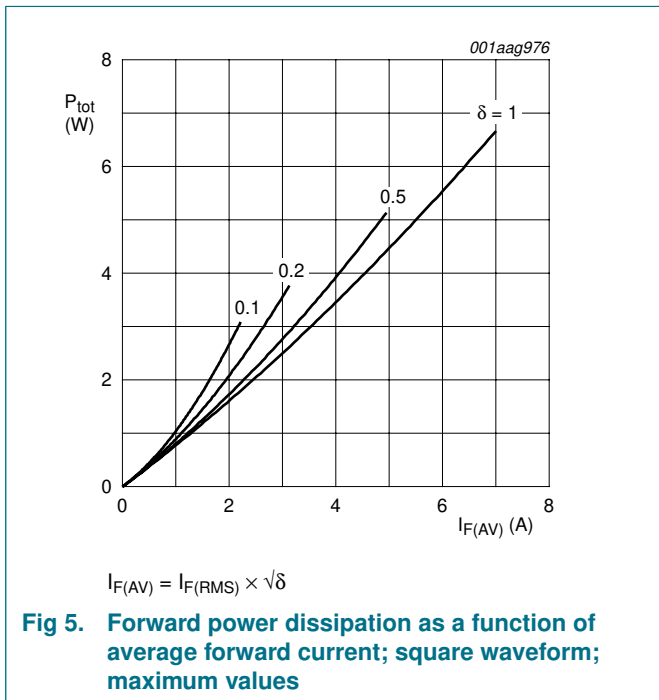

Fig 5. Forward power dissipation as a function of average forward current; square waveform; maximum values

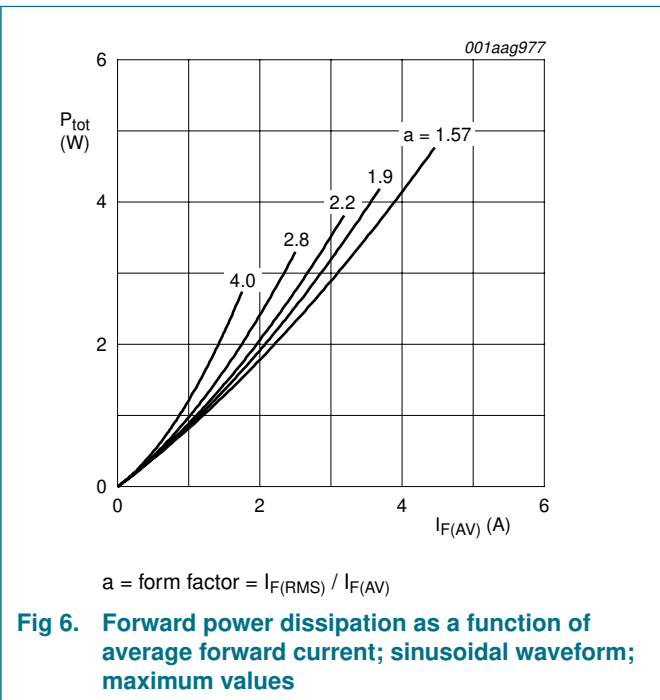
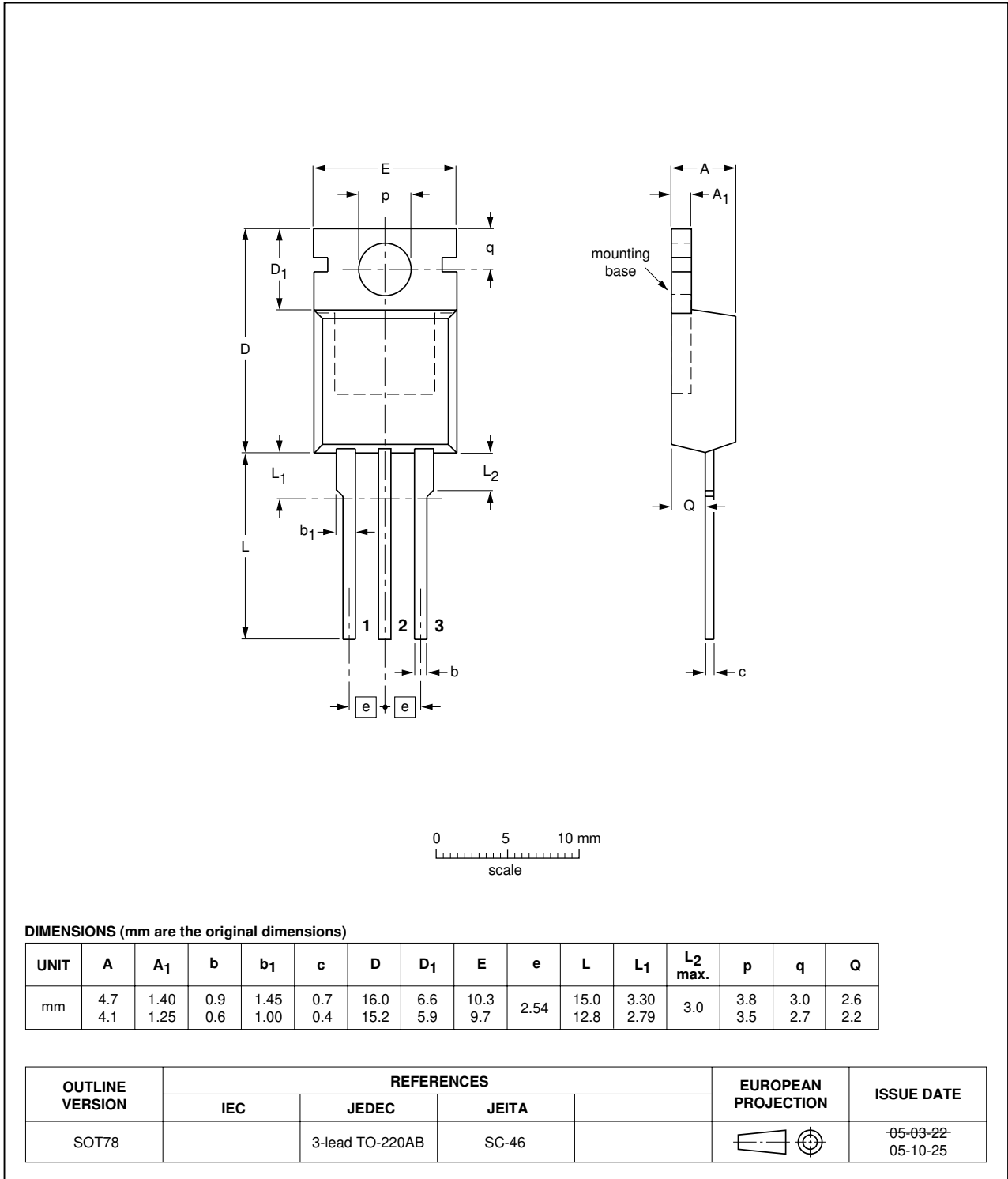

Fig 6. Forward power dissipation as a function of average forward current; sinusoidal waveform; maximum values

**7. Package outline**

Plastic single-ended package; heatsink mounted; 1 mounting hole; 3-lead TO-220AB

SOT78

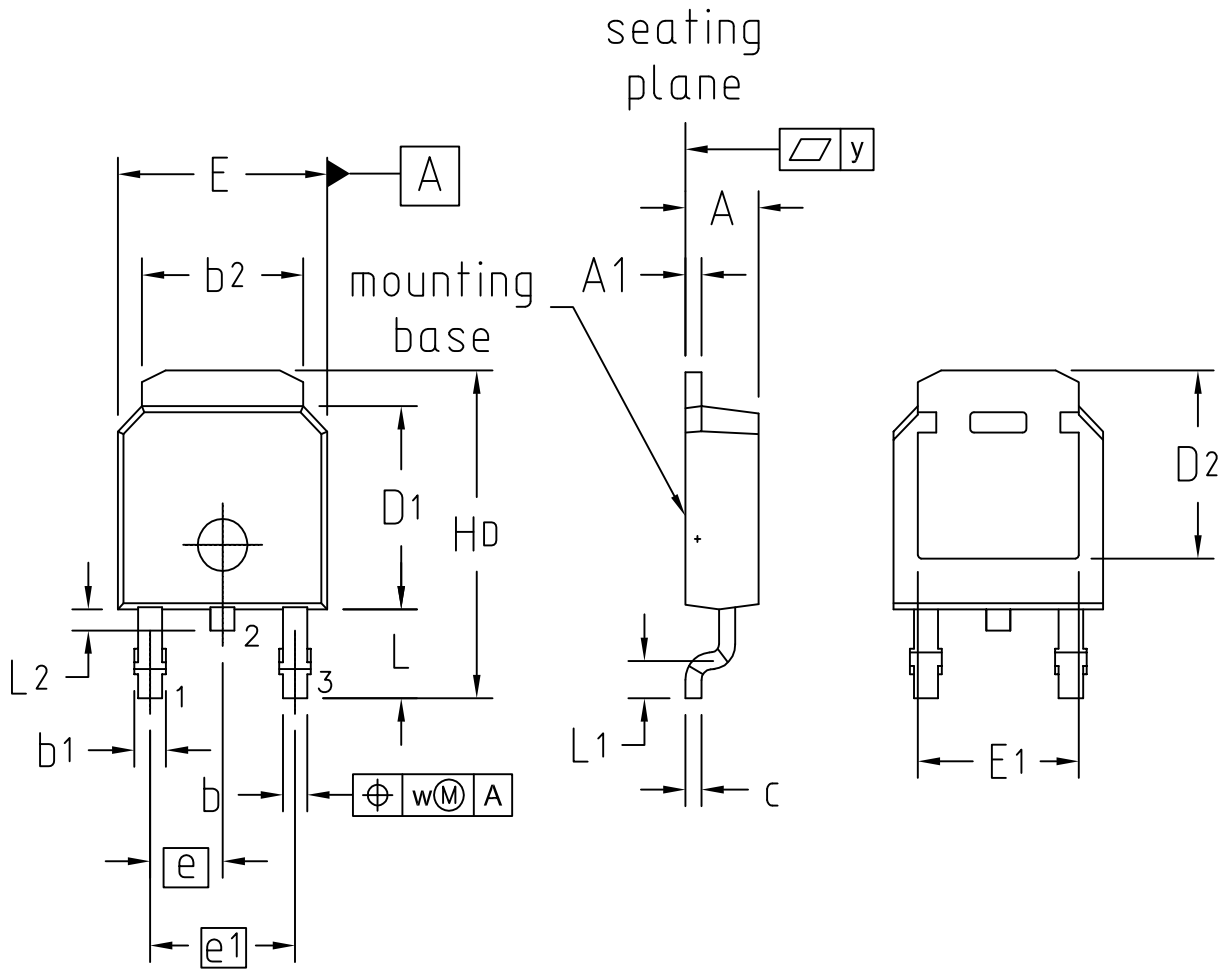

**Fig 7. Package outline SOT78 (TO-220AB)**



Plastic single-ended surface-mounted package (DPAK); 3 leads (one lead cropped)

SOT428



UNIT	A	A <sub>1</sub>	b	b <sub>1</sub>	b <sub>2</sub>	c	D <sub>1</sub>	D <sub>2</sub>	E	E <sub>1</sub>	e	e <sub>1</sub>	H <sub>d</sub>	L	L <sub>1</sub>	L <sub>2</sub>	w	y
mm	2.38	0.93	0.89	1.1	5.46	0.56	6.22	4.00	6.73	4.45	2.285	4.57	10.40	2.95	0.5	0.90	0.2	0.20
	2.22	0.46	0.71	0.9	5.00	0.20	5.98	min.	6.47	min.			9.60	2.55	min.	0.50	0.2	max.

OUTLINE VERSION	REFERENCES				EUROPEAN PROJECTION	ISSUE DATE
	IEC	JEDEC	EIAJ			
SOT428		TO-252				

Fig. 8. Package outline DPAK (SOT428)

## 8. Revision history

**Table 6. Revision history**

Document ID	Release date	Data sheet status	Change notice	Supersedes
BYQ28_SER_E_ED_4	20071205	Product data sheet	-	BYQ28E_SERIES_3
Modifications:		<ul style="list-style-type: none"> <li>The format of this data sheet has been redesigned to comply with the new identity guidelines of NXP Semiconductors.</li> <li>Legal texts have been adapted to the new company name where appropriate.</li> <li>Limiting values table: some parameter descriptions amended to conform to latest standards; <math>I_{FRM}</math> conditions amended; <math>V_{ESD}</math> row added.</li> <li>Characteristics: <math>Q_{rr}</math> changed to <math>Q_r</math> 'recovered charge'; <math>t_{rr1}</math> and <math>t_{rr2}</math> changed to <math>t_{rr}</math> with 'ramp recovery' and 'step recovery' added to conditions.</li> </ul>		
BYQ28E_SERIES_3	19981001	Product specification	-	BYQ28E_SERIES_2
BYQ28E_SERIES_2	19980701	Product specification	-	BYQ28E_SERIES_1; BYQ28EB_SERIES_1
BYQ28E_SERIES_1; BYQ28EB_SERIES_1	19960801	Product specification	-	-

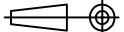
## 9. Legal information

### 9.1 Data sheet status

Document status <sup>[1][2]</sup>	Product status <sup>[3]</sup>	Definition
Objective [short] data sheet	Development	This document contains data from the objective specification for product development.
Preliminary [short] data sheet	Qualification	This document contains data from the preliminary specification.
Product [short] data sheet	Production	This document contains the product specification.

[1] Please consult the most recently issued document before initiating or completing a design.

[2] The term 'short data sheet' is explained in section "Definitions".

[3] The product status of device(s) described in this document may have changed since this document was published and may differ in case of multiple devices. The latest product status information is available on the Internet at URL <http://www.nxp.com>.

### 9.2 Definitions

**Draft** — The document is a draft version only. The content is still under internal review and subject to formal approval, which may result in modifications or additions. NXP Semiconductors does not give any representations or warranties as to the accuracy or completeness of information included herein and shall have no liability for the consequences of use of such information.

**Short data sheet** — A short data sheet is an extract from a full data sheet with the same product type number(s) and title. A short data sheet is intended for quick reference only and should not be relied upon to contain detailed and full information. For detailed and full information see the relevant full data sheet, which is available on request via the local NXP Semiconductors sales office. In case of any inconsistency or conflict with the short data sheet, the full data sheet shall prevail.

### 9.3 Disclaimers

**General** — Information in this document is believed to be accurate and reliable. However, NXP Semiconductors does not give any representations or warranties, expressed or implied, as to the accuracy or completeness of such information and shall have no liability for the consequences of use of such information.

**Right to make changes** — NXP Semiconductors reserves the right to make changes to information published in this document, including without limitation specifications and product descriptions, at any time and without notice. This document supersedes and replaces all information supplied prior to the publication hereof.

**Suitability for use** — NXP Semiconductors products are not designed, authorized or warranted to be suitable for use in medical, military, aircraft, space or life support equipment, nor in applications where failure or

malfunction of an NXP Semiconductors product can reasonably be expected to result in personal injury, death or severe property or environmental damage. NXP Semiconductors accepts no liability for inclusion and/or use of NXP Semiconductors products in such equipment or applications and therefore such inclusion and/or use is at the customer's own risk.

**Applications** — Applications that are described herein for any of these products are for illustrative purposes only. NXP Semiconductors makes no representation or warranty that such applications will be suitable for the specified use without further testing or modification.

**Limiting values** — Stress above one or more limiting values (as defined in the Absolute Maximum Ratings System of IEC 60134) may cause permanent damage to the device. Limiting values are stress ratings only and operation of the device at these or any other conditions above those given in the Characteristics sections of this document is not implied. Exposure to limiting values for extended periods may affect device reliability.

**Terms and conditions of sale** — NXP Semiconductors products are sold subject to the general terms and conditions of commercial sale, as published at <http://www.nxp.com/profile/terms>, including those pertaining to warranty, intellectual property rights infringement and limitation of liability, unless explicitly otherwise agreed to in writing by NXP Semiconductors. In case of any inconsistency or conflict between information in this document and such terms and conditions, the latter will prevail.

**No offer to sell or license** — Nothing in this document may be interpreted or construed as an offer to sell products that is open for acceptance or the grant, conveyance or implication of any license under any copyrights, patents or other industrial or intellectual property rights.

### 9.4 Trademarks

Notice: All referenced brands, product names, service names and trademarks are the property of their respective owners.

## 10. Contact information

For additional information, please visit: <http://www.nxp.com>

For sales office addresses, send an email to: [salesaddresses@nxp.com](mailto:salesaddresses@nxp.com)

## 11. Contents

<b>1</b>	<b>Product profile</b> . . . . .	<b>1</b>
1.1	General description . . . . .	1
1.2	Features . . . . .	1
1.3	Applications . . . . .	1
1.4	Quick reference data . . . . .	1
<b>2</b>	<b>Pinning information</b> . . . . .	<b>1</b>
<b>3</b>	<b>Ordering information</b> . . . . .	<b>2</b>
<b>4</b>	<b>Limiting values</b> . . . . .	<b>2</b>
<b>5</b>	<b>Thermal characteristics</b> . . . . .	<b>3</b>
<b>6</b>	<b>Characteristics</b> . . . . .	<b>4</b>
<b>7</b>	<b>Package outline</b> . . . . .	<b>6</b>
<b>8</b>	<b>Revision history</b> . . . . .	<b>8</b>
<b>9</b>	<b>Legal information</b> . . . . .	<b>9</b>
9.1	Data sheet status . . . . .	9
9.2	Definitions . . . . .	9
9.3	Disclaimers . . . . .	9
9.4	Trademarks . . . . .	9
<b>10</b>	<b>Contact information</b> . . . . .	<b>9</b>
<b>11</b>	<b>Contents</b> . . . . .	<b>10</b>

Please be aware that important notices concerning this document and the product(s) described herein, have been included in section 'Legal information'.



© NXP B.V. 2007.

All rights reserved.

For more information, please visit: <http://www.nxp.com>

For sales office addresses, please send an email to: [salesaddresses@nxp.com](mailto:salesaddresses@nxp.com)

Date of release: 5 December 2007

Document identifier: BYQ28\_SER\_E\_ED\_4