



Chipsmall Limited consists of a professional team with an average of over 10 year of expertise in the distribution of electronic components. Based in Hongkong, we have already established firm and mutual-benefit business relationships with customers from,Europe,America and south Asia,supplying obsolete and hard-to-find components to meet their specific needs.

With the principle of “Quality Parts,Customers Priority,Honest Operation,and Considerate Service”,our business mainly focus on the distribution of electronic components. Line cards we deal with include Microchip,ALPS,ROHM,Xilinx,Pulse,ON,Everlight and Freescale. Main products comprise IC,Modules,Potentiometer,IC Socket,Relay,Connector.Our parts cover such applications as commercial,industrial, and automotives areas.

We are looking forward to setting up business relationship with you and hope to provide you with the best service and solution. Let us make a better world for our industry!



Contact us

Tel: +86-755-8981 8866 Fax: +86-755-8427 6832

Email & Skype: info@chipsmall.com Web: www.chipsmall.com

Address: A1208, Overseas Decoration Building, #122 Zhenhua RD., Futian, Shenzhen, China



Important notice

Dear Customer,

On 7 February 2017 the former NXP Standard Product business became a new company with the tradename **Nexperia**. Nexperia is an industry leading supplier of Discrete, Logic and PowerMOS semiconductors with its focus on the automotive, industrial, computing, consumer and wearable application markets

In data sheets and application notes which still contain NXP or Philips Semiconductors references, use the references to Nexperia, as shown below.

Instead of <http://www.nxp.com>, <http://www.philips.com/> or <http://www.semiconductors.philips.com/>, use <http://www.nexperia.com>

Instead of sales.addresses@www.nxp.com or sales.addresses@www.semiconductors.philips.com, use salesaddresses@nexperia.com (email)

Replace the copyright notice at the bottom of each page or elsewhere in the document, depending on the version, as shown below:

- © NXP N.V. (year). All rights reserved or © Koninklijke Philips Electronics N.V. (year). All rights reserved

Should be replaced with:

- © **Nexperia B.V. (year). All rights reserved.**

If you have any questions related to the data sheet, please contact our nearest sales office via e-mail or telephone (details via salesaddresses@nexperia.com). Thank you for your cooperation and understanding,

Kind regards,

Team Nexperia

DATA SHEET

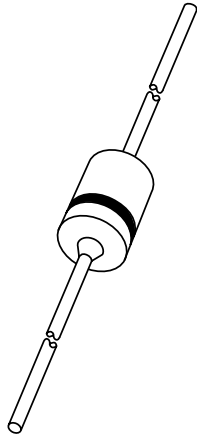

BZX79 series Voltage regulator diodes

Product data sheet
Supersedes data of 1999 May 25

2002 Feb 27

Voltage regulator diodes

BZX79 series

FEATURES

- Total power dissipation: max. 500 mW
- Two tolerance series: $\pm 2\%$, and approx. $\pm 5\%$
- Working voltage range: nom. 2.4 to 75 V (E24 range)
- Non-repetitive peak reverse power dissipation: max. 40 W.

APPLICATIONS

- Low voltage stabilizers or voltage references.

DESCRIPTION

Low-power voltage regulator diodes in hermetically sealed leaded glass SOD27 (DO-35) packages. The diodes are available in the normalized E24 $\pm 2\%$ (BZX79-B) and approx. $\pm 5\%$ (BZX79-C) tolerance range. The series consists of 37 types with nominal working voltages from 2.4 to 75 V.

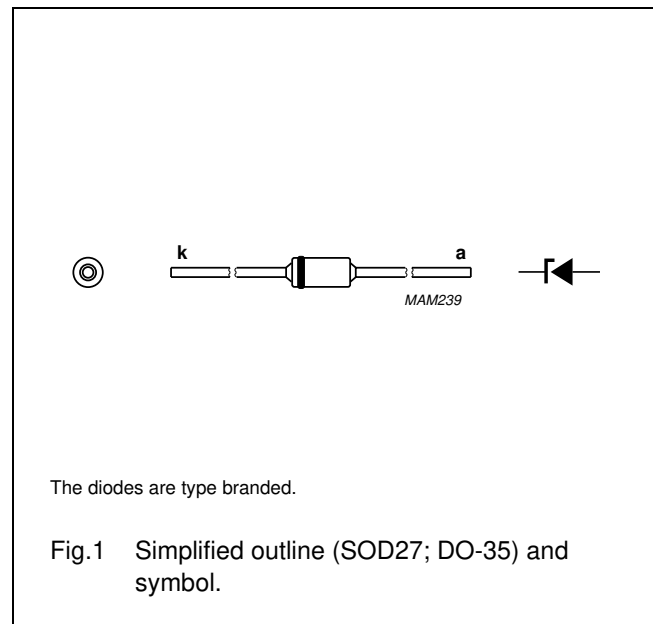

LIMITING VALUES

In accordance with the Absolute Maximum Rating System (IEC 60134).

| SYMBOL | PARAMETER | CONDITIONS | MIN. | MAX. | UNIT |
|-----------|---|---|--------------------|------|------------------|
| I_F | continuous forward current | | – | 250 | mA |
| I_{ZSM} | non-repetitive peak reverse current | $t_p = 100 \mu s$; square wave; $T_j = 25 \text{ }^\circ\text{C}$ prior to surge | see Tables 1 and 2 | | A |
| P_{tot} | total power dissipation | $T_{amb} = 50 \text{ }^\circ\text{C}$; note 1 | – | 400 | mW |
| | | $T_{amb} = 50 \text{ }^\circ\text{C}$; note 2 | – | 500 | mW |
| P_{ZSM} | non-repetitive peak reverse power dissipation | $t_p = 100 \mu s$; square wave; $T_j = 25 \text{ }^\circ\text{C}$ prior to surge; see Fig.3 | – | 40 | W |
| T_{stg} | storage temperature | | –65 | +200 | $^\circ\text{C}$ |
| T_j | junction temperature | | –65 | +200 | $^\circ\text{C}$ |

Notes

1. Device mounted on a printed circuit-board without metallization pad; lead length max.
2. Tie-point temperature $\leq 50 \text{ }^\circ\text{C}$; max. lead length 8 mm.

ELECTRICAL CHARACTERISTICS

Total BZX79-B and BZX79-C series

$T_j = 25 \text{ }^\circ\text{C}$ unless otherwise specified.

| SYMBOL | PARAMETER | CONDITIONS | MAX. | UNIT |
|--------|-----------------|-----------------------------------|------|------|
| V_F | forward voltage | $I_F = 10 \text{ mA}$; see Fig.4 | 0.9 | V |

Voltage regulator diodes

BZX79 series

| SYMBOL | PARAMETER | CONDITIONS | MAX. | UNIT |
|----------------------------|---------------------------------------|----------------------|------|------|
| I _R | reverse current | | | |
| | BZX79-B/C2V4 | V _R = 1 V | 50 | μA |
| | BZX79-B/C2V7 | V _R = 1 V | 20 | μA |
| | BZX79-B/C3V0 | V _R = 1 V | 10 | μA |
| | BZX79-B/C3V3 | V _R = 1 V | 5 | μA |
| | BZX79-B/C3V6 | V _R = 1 V | 5 | μA |
| | BZX79-B/C3V9 | V _R = 1 V | 3 | μA |
| | BZX79-B/C4V3 | V _R = 1 V | 3 | μA |
| | BZX79-B/C4V7 | V _R = 2 V | 3 | μA |
| | BZX79-B/C5V1 | V _R = 2 V | 2 | μA |
| | BZX79-B/C5V6 | V _R = 2 V | 1 | μA |
| | BZX79-B/C6V2 | V _R = 4 V | 3 | μA |
| | BZX79-B/C6V8 | V _R = 4 V | 2 | μA |
| | BZX79-B/C7V5 | V _R = 5 V | 1 | μA |
| | BZX79-B/C8V2 | V _R = 5 V | 700 | nA |
| | BZX79-B/C9V1 | V _R = 6 V | 500 | nA |
| | BZX79-B/C10 | V _R = 7 V | 200 | nA |
| | BZX79-B/C11 | V _R = 8 V | 100 | nA |
| | BZX79-B/C12 | V _R = 8 V | 100 | nA |
| BZX79-B/C13 | V _R = 8 V | 100 | nA | |
| BZX79-B/C15 to BZX79-B/C75 | V _R = 0.7V _{Znom} | 50 | nA | |

Voltage regulator diodes

BZX79 series

Table 1 Per type, BZX79-B/C2V4 to BZX79-B/C24 $T_j = 25\text{ °C}$ unless otherwise specified.

| BZX79- Bxxx Cxxx | WORKING VOLTAGE V_z (V) at $I_{ztest} = 5\text{ mA}$ | | | | DIFFERENTIAL RESISTANCE r_{dif} (Ω) | | | | TEMP. COEFF. S_z (mV/K) at $I_{ztest} = 5\text{ mA}$ (see Figs 5 and 6) | | | DIODE CAP. C_d (pF) at $f = 1\text{ MHz}$; $V_R = 0\text{ V}$ | NON-REPETITIVE PEAK REVERSE CURRENT I_{zSM} (A) at $t_p = 100\text{ }\mu\text{s}$; $T_{amb} = 25\text{ °C}$ |
|------------------------|--|-------|-------------------------------|------|---|------|------------------------------|------|--|------|------|---|---|
| | Tol. $\pm 2\%$ (B) | | Tol. approx. $\pm 5\%$ (C) | | at $I_{ztest} = 1\text{ mA}$ | | at $I_{ztest} = 5\text{ mA}$ | | MIN. | TYP. | MAX. | MAX. | MAX. |
| | MIN. | MAX. | MIN. | MAX. | TYP. | MAX. | TYP. | MAX. | | | | | |
| 2V4 | 2.35 | 2.45 | 2.2 | 2.6 | 275 | 600 | 70 | 100 | -3.5 | -1.6 | 0 | 450 | 6.0 |
| 2V7 | 2.65 | 2.75 | 2.5 | 2.9 | 300 | 600 | 75 | 100 | -3.5 | -2.0 | 0 | 450 | 6.0 |
| 3V0 | 2.94 | 3.06 | 2.8 | 3.2 | 325 | 600 | 80 | 95 | -3.5 | -2.1 | 0 | 450 | 6.0 |
| 3V3 | 3.23 | 3.37 | 3.1 | 3.5 | 350 | 600 | 85 | 95 | -3.5 | -2.4 | 0 | 450 | 6.0 |
| 3V6 | 3.53 | 3.67 | 3.4 | 3.8 | 375 | 600 | 85 | 90 | -3.5 | -2.4 | 0 | 450 | 6.0 |
| 3V9 | 3.82 | 3.98 | 3.7 | 4.1 | 400 | 600 | 85 | 90 | -3.5 | -2.5 | 0 | 450 | 6.0 |
| 4V3 | 4.21 | 4.39 | 4.0 | 4.6 | 410 | 600 | 80 | 90 | -3.5 | -2.5 | 0 | 450 | 6.0 |
| 4V7 | 4.61 | 4.79 | 4.4 | 5.0 | 425 | 500 | 50 | 80 | -3.5 | -1.4 | 0.2 | 300 | 6.0 |
| 5V1 | 5.00 | 5.20 | 4.8 | 5.4 | 400 | 480 | 40 | 60 | -2.7 | -0.8 | 1.2 | 300 | 6.0 |
| 5V6 | 5.49 | 5.71 | 5.2 | 6.0 | 80 | 400 | 15 | 40 | -2.0 | 1.2 | 2.5 | 300 | 6.0 |
| 6V2 | 6.08 | 6.32 | 5.8 | 6.6 | 40 | 150 | 6 | 10 | 0.4 | 2.3 | 3.7 | 200 | 6.0 |
| 6V8 | 6.66 | 6.94 | 6.4 | 7.2 | 30 | 80 | 6 | 15 | 1.2 | 3.0 | 4.5 | 200 | 6.0 |
| 7V5 | 7.35 | 7.65 | 7.0 | 7.9 | 30 | 80 | 6 | 15 | 2.5 | 4.0 | 5.3 | 150 | 4.0 |
| 8V2 | 8.04 | 8.36 | 7.7 | 8.7 | 40 | 80 | 6 | 15 | 3.2 | 4.6 | 6.2 | 150 | 4.0 |
| 9V1 | 8.92 | 9.28 | 8.5 | 9.6 | 40 | 100 | 6 | 15 | 3.8 | 5.5 | 7.0 | 150 | 3.0 |
| 10 | 9.80 | 10.20 | 9.4 | 10.6 | 50 | 150 | 8 | 20 | 4.5 | 6.4 | 8.0 | 90 | 3.0 |
| 11 | 10.80 | 11.20 | 10.4 | 11.6 | 50 | 150 | 10 | 20 | 5.4 | 7.4 | 9.0 | 85 | 2.5 |
| 12 | 11.80 | 12.20 | 11.4 | 12.7 | 50 | 150 | 10 | 25 | 6.0 | 8.4 | 10.0 | 85 | 2.5 |
| 13 | 12.70 | 13.30 | 12.4 | 14.1 | 50 | 170 | 10 | 30 | 7.0 | 9.4 | 11.0 | 80 | 2.5 |
| 15 | 14.70 | 15.30 | 13.8 | 15.6 | 50 | 200 | 10 | 30 | 9.2 | 11.4 | 13.0 | 75 | 2.0 |
| 16 | 15.70 | 16.30 | 15.3 | 17.1 | 50 | 200 | 10 | 40 | 10.4 | 12.4 | 14.0 | 75 | 1.5 |
| 18 | 17.60 | 18.40 | 16.8 | 19.1 | 50 | 225 | 10 | 45 | 12.4 | 14.4 | 16.0 | 70 | 1.5 |
| 20 | 19.60 | 20.40 | 18.8 | 21.2 | 60 | 225 | 15 | 55 | 12.3 | 15.6 | 18.0 | 60 | 1.5 |
| 22 | 21.60 | 22.40 | 20.8 | 23.3 | 60 | 250 | 20 | 55 | 14.1 | 17.6 | 20.0 | 60 | 1.25 |
| 24 | 23.50 | 24.50 | 22.8 | 25.6 | 60 | 250 | 25 | 70 | 15.9 | 19.6 | 22.0 | 55 | 1.25 |

Voltage regulator diodes

BZX79 series

Table 2 Per type, BZX79-B/C27 to BZX79-B/C75 $T_j = 25\text{ °C}$ unless otherwise specified.

| BZX79- Bxxx Cxxx | WORKING VOLTAGE V_z (V) at $I_{ztest} = 2\text{ mA}$ | | | | DIFFERENTIAL RESISTANCE r_{dif} (Ω) | | | | TEMP. COEFF. S_z (mV/K) at $I_{ztest} = 2\text{ mA}$ (see Figs 5 and 6) | | | DIODE CAP. C_d (pF) at $f = 1\text{ MHz}$; $V_R = 0\text{ V}$ | NON-REPETITIVE PEAK REVERSE CURRENT I_{zSM} (A) at $t_p = 100\text{ }\mu\text{s}$; $T_{amb} = 25\text{ °C}$ |
|------------------------|--|-------|-------------------------------|------|---|------|------------------------------|------|--|------|------|---|---|
| | Tol. $\pm 2\%$ (B) | | Tol. approx. $\pm 5\%$ (C) | | at $I_{ztest} = 0.5\text{ mA}$ | | at $I_{ztest} = 2\text{ mA}$ | | MIN. | TYP. | MAX. | MAX. | MAX. |
| | MIN. | MAX. | MIN. | MAX. | TYP. | MAX. | TYP. | MAX. | | | | | |
| 27 | 26.50 | 27.50 | 25.1 | 28.9 | 65 | 300 | 25 | 80 | 18.0 | 22.7 | 25.3 | 50 | 1.0 |
| 30 | 29.40 | 30.60 | 28.0 | 32.0 | 70 | 300 | 30 | 80 | 20.6 | 25.7 | 29.4 | 50 | 1.0 |
| 33 | 32.30 | 33.70 | 31.0 | 35.0 | 75 | 325 | 35 | 80 | 23.3 | 28.7 | 33.4 | 45 | 0.9 |
| 36 | 35.30 | 36.70 | 34.0 | 38.0 | 80 | 350 | 35 | 90 | 26.0 | 31.8 | 37.4 | 45 | 0.8 |
| 39 | 38.20 | 39.80 | 37.0 | 41.0 | 80 | 350 | 40 | 130 | 28.7 | 34.8 | 41.2 | 45 | 0.7 |
| 43 | 42.10 | 43.90 | 40.0 | 46.0 | 85 | 375 | 45 | 150 | 31.4 | 38.8 | 46.6 | 40 | 0.6 |
| 47 | 46.10 | 47.90 | 44.0 | 50.0 | 85 | 375 | 50 | 170 | 35.0 | 42.9 | 51.8 | 40 | 0.5 |
| 51 | 50.00 | 52.00 | 48.0 | 54.0 | 90 | 400 | 60 | 180 | 38.6 | 46.9 | 57.2 | 40 | 0.4 |
| 56 | 54.90 | 57.10 | 52.0 | 60.0 | 100 | 425 | 70 | 200 | 42.2 | 52.0 | 63.8 | 40 | 0.3 |
| 62 | 60.80 | 63.20 | 58.0 | 66.0 | 120 | 450 | 80 | 215 | 58.8 | 64.4 | 71.6 | 35 | 0.3 |
| 68 | 66.60 | 69.40 | 64.0 | 72.0 | 150 | 475 | 90 | 240 | 65.6 | 71.7 | 79.8 | 35 | 0.25 |
| 75 | 73.50 | 76.50 | 70.0 | 79.0 | 170 | 500 | 95 | 255 | 73.4 | 80.2 | 88.6 | 35 | 0.2 |

Voltage regulator diodes

BZX79 series

THERMAL CHARACTERISTICS

| SYMBOL | PARAMETER | CONDITIONS | VALUE | UNIT |
|----------------|---|--|-------|------|
| $R_{th\ j-tp}$ | thermal resistance from junction to tie-point | lead length 8 mm. | 300 | K/W |
| $R_{th\ j-a}$ | thermal resistance from junction to ambient | lead length max.; see Fig.2 and note 1 | 380 | K/W |

Note

1. Device mounted on a printed circuit-board without metallization pad.

GRAPHICAL DATA

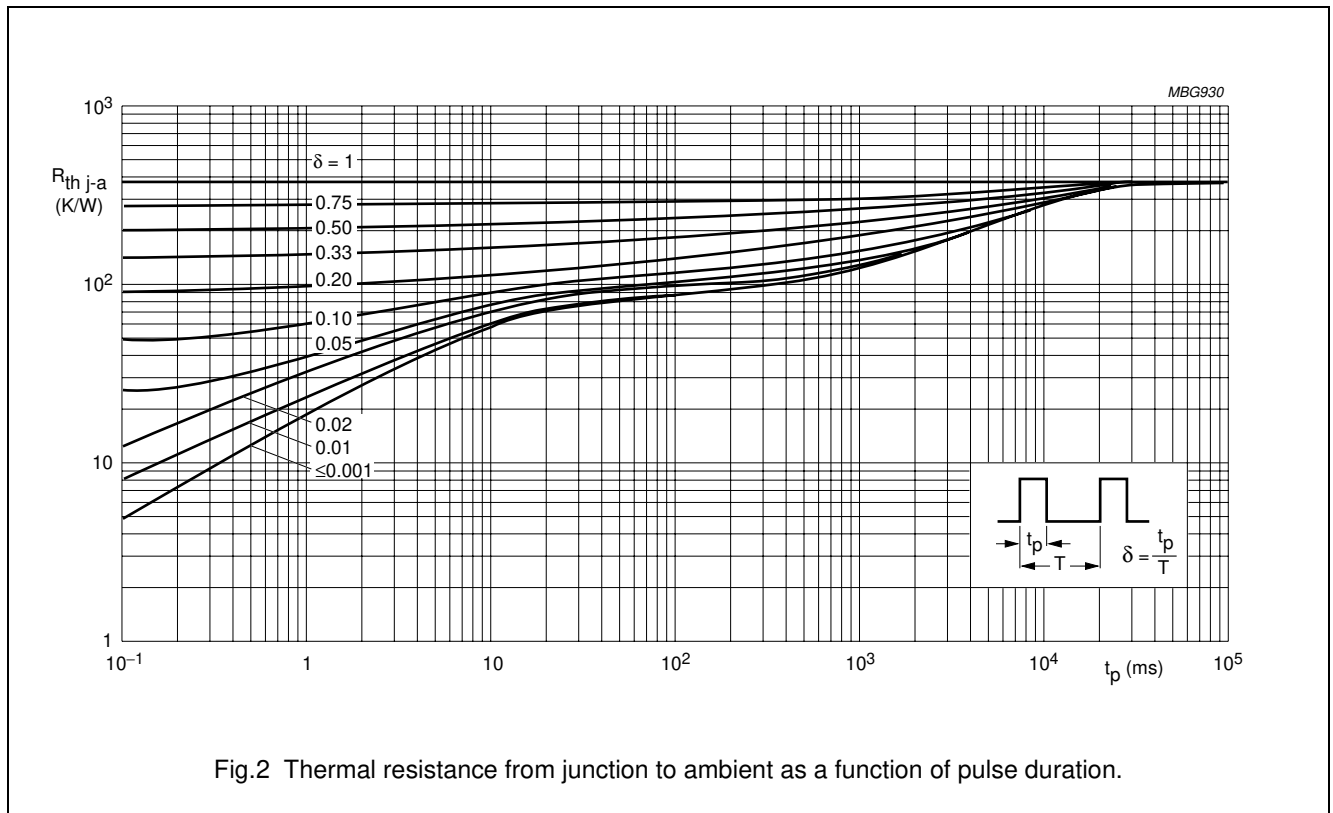
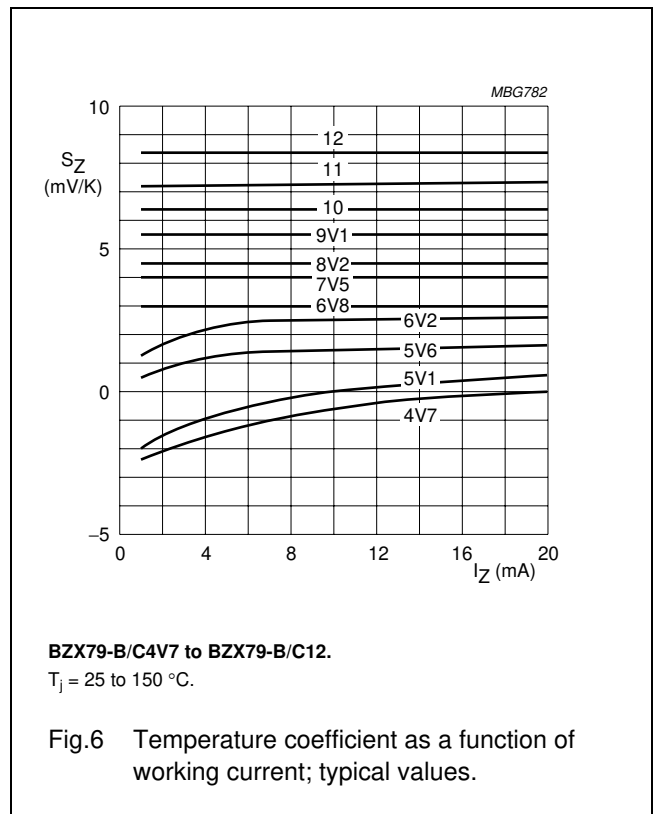
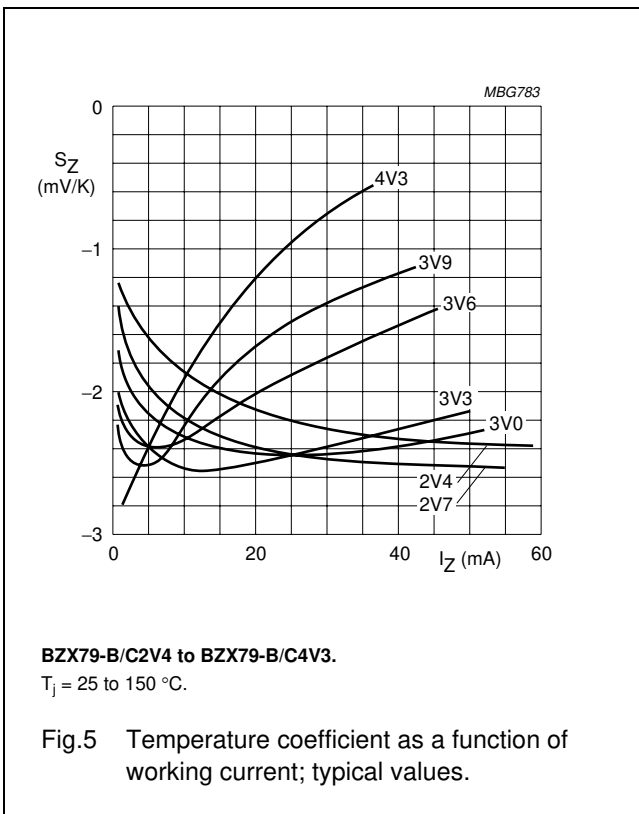
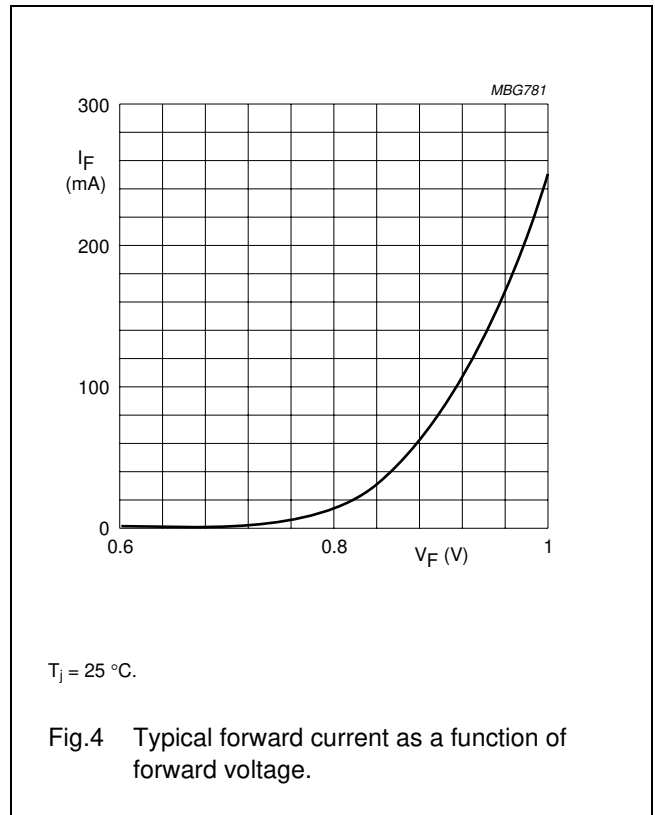
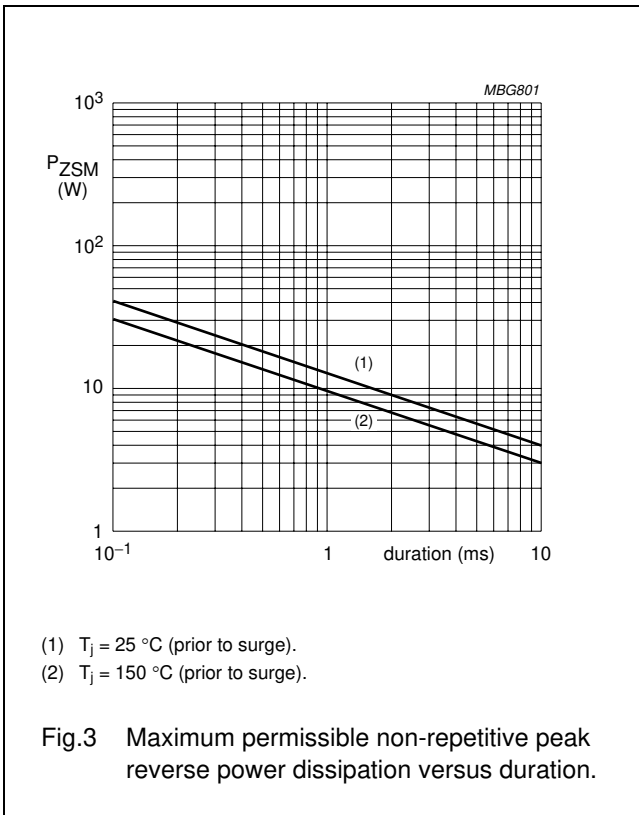

Fig.2 Thermal resistance from junction to ambient as a function of pulse duration.

Voltage regulator diodes

BZX79 series



Voltage regulator diodes

BZX79 series

PACKAGE OUTLINE

Hermetically sealed glass package; axial leaded; 2 leads

SOD27

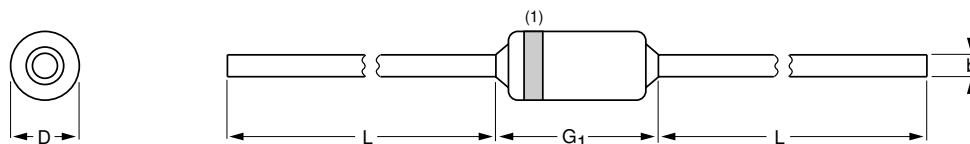

DIMENSIONS (mm are the original dimensions)

| UNIT | b max. | D max. | G ₁ max. | L min. |
|------|-----------|-----------|------------------------|-----------|
| mm | 0.56 | 1.85 | 4.25 | 25.4 |

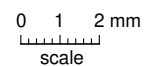

Note

1. The marking band indicates the cathode.

| OUTLINE VERSION | REFERENCES | | | | EUROPEAN PROJECTION | ISSUE DATE |
|--------------------|------------|-------|-------|--|------------------------|------------|
| | IEC | JEDEC | EIAJ | | | |
| SOD27 | A24 | DO-35 | SC-40 | | | 97-06-09 |

Voltage regulator diodes

BZX79 series

DATA SHEET STATUS

| DOCUMENT STATUS ⁽¹⁾ | PRODUCT STATUS ⁽²⁾ | DEFINITION |
|--------------------------------|-------------------------------|---|
| Objective data sheet | Development | This document contains data from the objective specification for product development. |
| Preliminary data sheet | Qualification | This document contains data from the preliminary specification. |
| Product data sheet | Production | This document contains the product specification. |

Notes

1. Please consult the most recently issued document before initiating or completing a design.
2. The product status of device(s) described in this document may have changed since this document was published and may differ in case of multiple devices. The latest product status information is available on the Internet at URL <http://www.nxp.com>.

DISCLAIMERS

General — Information in this document is believed to be accurate and reliable. However, NXP Semiconductors does not give any representations or warranties, expressed or implied, as to the accuracy or completeness of such information and shall have no liability for the consequences of use of such information.

Right to make changes — NXP Semiconductors reserves the right to make changes to information published in this document, including without limitation specifications and product descriptions, at any time and without notice. This document supersedes and replaces all information supplied prior to the publication hereof.

Suitability for use — NXP Semiconductors products are not designed, authorized or warranted to be suitable for use in medical, military, aircraft, space or life support equipment, nor in applications where failure or malfunction of an NXP Semiconductors product can reasonably be expected to result in personal injury, death or severe property or environmental damage. NXP Semiconductors accepts no liability for inclusion and/or use of NXP Semiconductors products in such equipment or applications and therefore such inclusion and/or use is at the customer's own risk.

Applications — Applications that are described herein for any of these products are for illustrative purposes only. NXP Semiconductors makes no representation or warranty that such applications will be suitable for the specified use without further testing or modification.

Limiting values — Stress above one or more limiting values (as defined in the Absolute Maximum Ratings System of IEC 60134) may cause permanent damage to the device. Limiting values are stress ratings only and operation of the device at these or any other conditions

above those given in the Characteristics sections of this document is not implied. Exposure to limiting values for extended periods may affect device reliability.

Terms and conditions of sale — NXP Semiconductors products are sold subject to the general terms and conditions of commercial sale, as published at <http://www.nxp.com/profile/terms>, including those pertaining to warranty, intellectual property rights infringement and limitation of liability, unless explicitly otherwise agreed to in writing by NXP Semiconductors. In case of any inconsistency or conflict between information in this document and such terms and conditions, the latter will prevail.

No offer to sell or license — Nothing in this document may be interpreted or construed as an offer to sell products that is open for acceptance or the grant, conveyance or implication of any license under any copyrights, patents or other industrial or intellectual property rights.

Export control — This document as well as the item(s) described herein may be subject to export control regulations. Export might require a prior authorization from national authorities.

Quick reference data — The Quick reference data is an extract of the product data given in the Limiting values and Characteristics sections of this document, and as such is not complete, exhaustive or legally binding.

NXP Semiconductors

Customer notification

This data sheet was changed to reflect the new company name NXP Semiconductors. No changes were made to the content, except for the legal definitions and disclaimers.

Contact information

For additional information please visit: **<http://www.nxp.com>**

For sales offices addresses send e-mail to: **salesaddresses@nxp.com**

© NXP B.V. 2009

All rights are reserved. Reproduction in whole or in part is prohibited without the prior written consent of the copyright owner.

The information presented in this document does not form part of any quotation or contract, is believed to be accurate and reliable and may be changed without notice. No liability will be accepted by the publisher for any consequence of its use. Publication thereof does not convey nor imply any license under patent- or other industrial or intellectual property rights.

Printed in The Netherlands

613514/03/pp10

Date of release: 2002 Feb 27

Document order number: 9397 750 09387

