



Chipsmall Limited consists of a professional team with an average of over 10 year of expertise in the distribution of electronic components. Based in Hongkong, we have already established firm and mutual-benefit business relationships with customers from,Europe,America and south Asia,supplying obsolete and hard-to-find components to meet their specific needs.

With the principle of “Quality Parts,Customers Priority,Honest Operation,and Considerate Service”,our business mainly focus on the distribution of electronic components. Line cards we deal with include Microchip,ALPS,ROHM,Xilinx,Pulse,ON,Everlight and Freescale. Main products comprise IC,Modules,Potentiometer,IC Socket,Relay,Connector.Our parts cover such applications as commercial,industrial, and automotives areas.

We are looking forward to setting up business relationship with you and hope to provide you with the best service and solution. Let us make a better world for our industry!



Contact us

Tel: +86-755-8981 8866 Fax: +86-755-8427 6832

Email & Skype: info@chipsmall.com Web: www.chipsmall.com

Address: A1208, Overseas Decoration Building, #122 Zhenhua RD., Futian, Shenzhen, China



Features

- Zener Voltages from 2.4 - 39V
- Three Isolated Diode Elements in a Single Ultra-Small Surface Mount Package
- **Lead Free/RoHS Compliant (Note 2)**
- **"Green" Device (Note 3 and 4)**



Top View

Mechanical Data

- Case: SOT-363
- Case Material: Molded Plastic. UL Flammability Classification Rating 94V-0
- Moisture Sensitivity: Level 1 per J-STD-020D
- Terminals: Solderable per MIL-STD-202, Method 208
- Lead Free Plating (Matte Tin Finish annealed over Alloy 42 leadframe).
- Orientation: See Diagram
- Marking Information: See Page 3
- Ordering Information: See Page 3
- Weight: 0.006 grams (approximate)

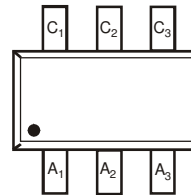

Package Pin Out Configuration

Maximum Ratings @ $T_A = 25^\circ\text{C}$ unless otherwise specified

Characteristic	Symbol	Value	Unit
Forward Voltage @ $I_F = 10\text{mA}$	V_F	0.9	V

Thermal Characteristics

Characteristic	Symbol	Value	Unit
Power Dissipation (Note 1)	P_D	200	mW
Thermal Resistance, Junction to Ambient Air (Note 1)	$R_{\theta JA}$	625	$^\circ\text{C/W}$
Operating and Storage Temperature Range	T_J, T_{STG}	-65 to +150	$^\circ\text{C}$

- Notes:
1. Mounted on FR4 PC Board with recommended pad layout which can be found on our website at <http://www.diodes.com/datasheets/ap02001.pdf>.
 2. No purposefully added lead.
 3. Diodes Inc.'s "Green" policy can be found on our website at http://www.diodes.com/products/lead_free/index.php.
 4. Product manufactured with Date Code UO (week 40, 2007) and newer are built with Green Molding Compound. Product manufactured prior to Date Code UO are built with Non-Green Molding Compound and may contain Halogens or Sb2O3 Fire Retardants.

Electrical Characteristics @T_A = 25°C unless otherwise specified

Type Number	Marking Code	Zener Voltage Range (Note 5)				Maximum Zener Impedance (Note 6)			Maximum Reverse Current (Note 5)		Temperature Coefficient of Zener Voltage @ I _{ZT} = 5mA mV/°C	
		V _Z @ I _{ZT}			I _{ZT}	Z _{ZT} @ I _{ZT}	Z _{ZK} @ I _{ZK}	I _{ZK}	I _R	V _R	Min	Max
		Nom (V)	Min (V)	Max (V)	mA	Ω		mA	μA	@ V		
BZX84C2V4TS	KRB	2.4	2.2	2.6	5	100	600	0.5	50	1.0	-3.5	0
BZX84C2V7TS	KRC	2.7	2.5	2.9	5	100	600	1.0	20	1.0	-3.5	0
BZX84C3V0TS	KRD	3.0	2.8	3.2	5	95	600	1.0	10	1.0	-3.5	0
BZX84C3V3TS	KRE	3.3	3.1	3.5	5	95	600	1.0	5.0	1.0	-3.5	0
BZX84C3V6TS	KRF	3.6	3.4	3.8	5	90	600	1.0	5.0	1.0	-3.5	0
BZX84C3V9TS	KRG	3.9	3.7	4.1	5	90	600	1.0	3.0	1.0	-3.5	0
BZX84C4V3TS	KRH	4.3	4.0	4.6	5	90	600	1.0	3.0	1.0	-3.5	0
BZX84C4V7TS	KR1	4.7	4.4	5.0	5	80	500	1.0	3.0	2.0	-3.5	0.2
BZX84C5V1TS	KR2	5.1	4.8	5.4	5	60	480	1.0	2.0	2.0	-2.7	1.2
BZX84C5V6TS	KR3	5.6	5.2	6.0	5	40	400	1.0	1.0	2.0	-2.0	2.5
BZX84C6V2TS	KR4	6.2	5.8	6.6	5	10	150	1.0	3.0	4.0	0.4	3.7
BZX84C6V8TS	KR5	6.8	6.4	7.2	5	15	80	1.0	2.0	4.0	1.2	4.5
BZX84C7V5TS	KR6	7.5	7.0	7.9	5	15	80	1.0	1.0	5.0	2.5	5.3
BZX84C8V2TS	KR7	8.2	7.7	8.7	5	15	80	1.0	0.7	5.0	3.2	6.2
BZX84C9V1TS	KR8	9.1	8.5	9.6	5	15	100	1.0	0.5	6.0	3.8	7.0
BZX84C10TS	KR9	10.0	9.4	10.6	5	20	150	1.0	0.2	7.0	4.5	8.0
BZX84C11TS	KP1	11.0	10.4	11.6	5	20	150	1.0	0.1	8.0	5.4	9.0
BZX84C12TS	KP2	12.0	11.4	12.7	5	25	150	1.0	0.1	8.0	6.0	10.0
BZX84C13TS	KP3	13.0	12.4	14.1	5	30	170	1.0	0.1	8.0	7.0	11.0
BZX84C15TS	KP4	15.0	13.8	15.6	5	30	200	1.0	0.1	10.5	9.2	13.0
BZX84C16TS	KP5	16.0	15.3	17.1	5	40	200	1.0	0.1	11.2	10.4	14.0
BZX84C18TS	KP6	18.0	16.8	19.1	5	45	225	1.0	0.1	12.6	12.4	16.0
BZX84C20TS	KP7	20.0	18.8	21.2	5	55	225	1.0	0.1	14.0	14.4	18.0
BZX84C22TS	KP8	22.0	20.8	23.3	5	55	250	1.0	0.1	15.4	16.4	20.0
BZX84C24TS	KP9	24.0	22.8	25.6	5	70	250	1.0	0.1	16.8	18.4	22.0
BZX84C27TS	KPA	27.0	25.1	28.9	2	80	300	0.5	0.1	18.9	21.4	25.3
BZX84C30TS	KPB	30.0	28.0	32.0	2	80	300	0.5	0.1	21.0	24.4	29.4
BZX84C33TS	KPC	33.0	31.0	35.0	2	80	325	0.5	0.1	23.1	27.4	33.4
BZX84C36TS	KPD	36.0	34.0	38.0	2	90	350	0.5	0.1	25.2	30.4	37.4
BZX84C39TS	KPE	39.0	37.0	41.0	2	130	350	0.5	0.1	27.3	33.4	41.2

Notes: 5. Short duration pulse test used to minimize self-heating effect.
6. f = 1KHz.

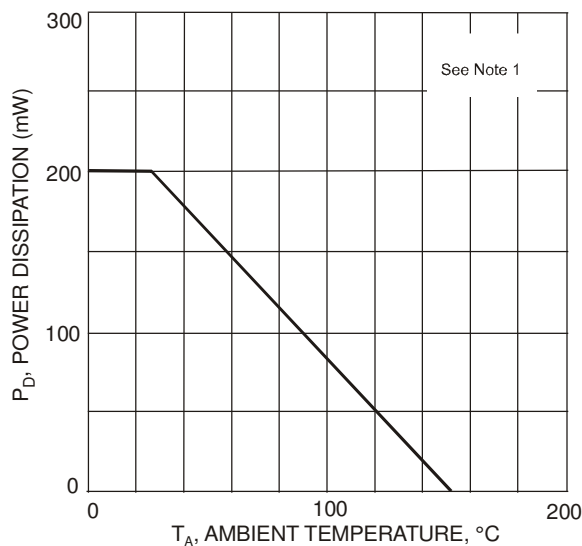

Fig. 1. Power Derating Curve

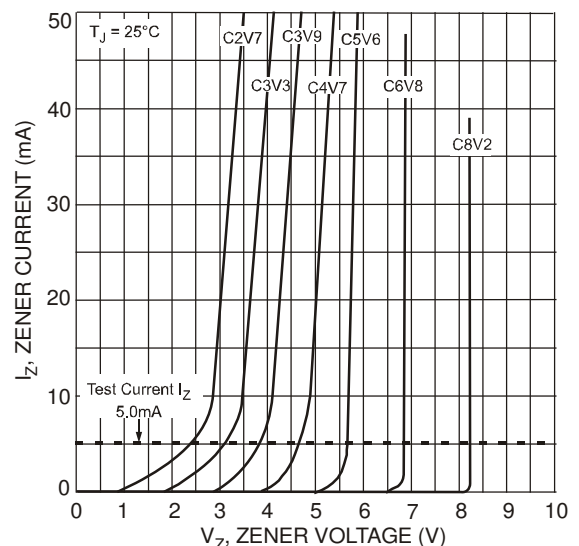

Fig. 2. Typical Zener Breakdown Characteristics

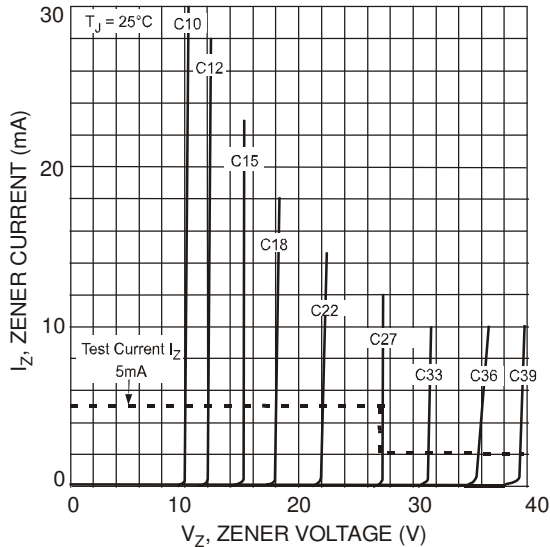

Fig. 3. Typical Zener Breakdown Characteristics

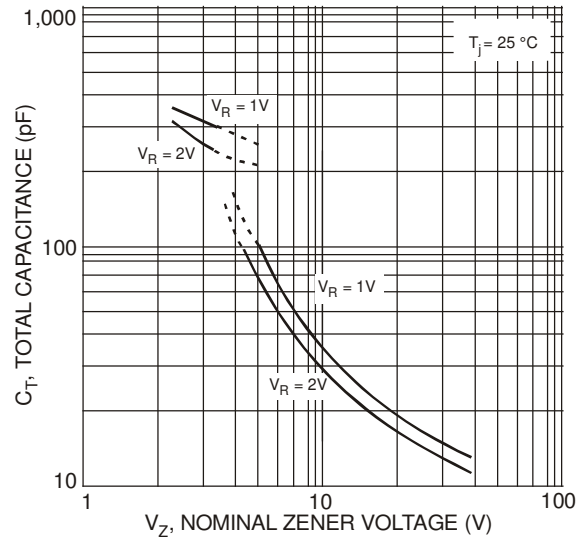

Fig. 4. Typical Total Capacitance vs. Nominal Zener Voltage

Ordering Information (Note 7)

Part Number	Case	Packaging
(Type Number)-7-F*	SOT-363	3000/Tape & Reel

*Add "-7-F" to the appropriate type number in Electrical Characteristics Table on Page 2 example: 6.2V Zener = BZX84C6V2TS-7-F.

Notes: 7. For packaging details, go to our website at <http://www.diodes.com/datasheets/ap02007.pdf>.

Marking Information

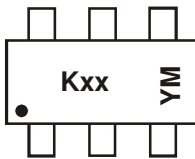

Kxx = Product Type Marking Code
(See Electrical Characteristics Table)
YM = Date Code Marking
Y = Year (ex: N = 2002)
M = Month (ex: 9 = September)

Date Code Key

Year	2002	2003	2004	2005	2006	2007	2008	2009	2010	2011	2012
Code	N	P	R	S	T	U	V	W	X	Y	Z

Month	Jan	Feb	Mar	Apr	May	Jun	Jul	Aug	Sep	Oct	Nov	Dec
Code	1	2	3	4	5	6	7	8	9	O	N	D

Package Outline Dimensions

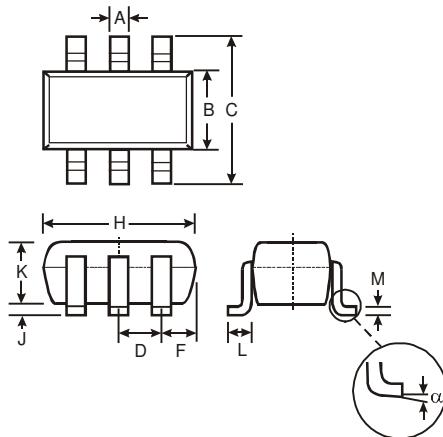

SOT-363		
Dim	Min	Max
A	0.10	0.30
B	1.15	1.35
C	2.00	2.20
D	0.65 Nominal	
F	0.40	0.45
H	1.80	2.20
J	0	0.10
K	0.90	1.00
L	0.25	0.40
M	0.10	0.22
α	0°	8°
All Dimensions in mm		

Suggested Pad Layout

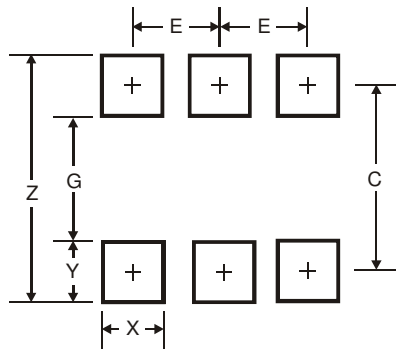

Dimensions	Value (in mm)
Z	2.5
G	1.3
X	0.42
Y	0.6
C	1.9
E	0.65

IMPORTANT NOTICE

Diodes Incorporated and its subsidiaries reserve the right to make modifications, enhancements, improvements, corrections or other changes without further notice to any product herein. Diodes Incorporated does not assume any liability arising out of the application or use of any product described herein; neither does it convey any license under its patent rights, nor the rights of others. The user of products in such applications shall assume all risks of such use and will agree to hold Diodes Incorporated and all the companies whose products are represented on our website, harmless against all damages.

LIFE SUPPORT

Diodes Incorporated products are not authorized for use as critical components in life support devices or systems without the expressed written approval of the President of Diodes Incorporated.