



Chipsmall Limited consists of a professional team with an average of over 10 year of expertise in the distribution of electronic components. Based in Hongkong, we have already established firm and mutual-benefit business relationships with customers from,Europe,America and south Asia,supplying obsolete and hard-to-find components to meet their specific needs.

With the principle of "Quality Parts,Customers Priority,Honest Operation,and Considerate Service",our business mainly focus on the distribution of electronic components. Line cards we deal with include Microchip,ALPS,ROHM,Xilinx,Pulse,ON,Everlight and Freescale. Main products comprise IC,Modules,Potentiometer,IC Socket,Relay,Connector.Our parts cover such applications as commercial,industrial, and automotives areas.

We are looking forward to setting up business relationship with you and hope to provide you with the best service and solution. Let us make a better world for our industry!



## Contact us

Tel: +86-755-8981 8866 Fax: +86-755-8427 6832

Email & Skype: info@chipsmall.com Web: www.chipsmall.com

Address: A1208, Overseas Decoration Building, #122 Zhenhua RD., Futian, Shenzhen, China





金龙机电股份有限公司  
JINLONG MACHINERY & ELECTRONIC CO., LTD.  
www.jinlong-machinery.com  
sales@jinlong-machinery.com

## 产品规格书

## PRODUCT SPECIFICATION

客 户 信 息	客户名称/ Buyer Name	
	客户料号/Buyer's Part No.	
	客户承认签章 /Buyer's Approval & Signatures	

金 龙 公 司	文件编号/Spec No.	KOTL-S15060	
	品名描述 Product Description	扁平振动马达 Coin type vibration motor	
	型号/Part No.	C0827B059F	
	送样日期/Date		
	设计/Designed by	审核/Checked by	批准/Approved by
	杨兰/YANG LAN	黄浦/HUANG PU	黄剑辉/HUANG HJ
	2015.06.06	2015.06.06	2015.06.06

# 规格书内容/ Contents

1. 适用范围/General Scope of Application	1/8
2. 使用条件/Operating Conditions	1/8
3. 测定条件/Conditions of Measurement	1/8
4. 电气性能/Electrical Characteristics	1/8
5. 机械性能/Mechanical Characteristics	2/8
6. 耐久性能/Reliability Test	2/8
7. 要求/Requirements after Reliability Tests	4/8
8. 使用注意事项/Cautions for Use	5/8
9. 包装/Packaging Description	6/8
10.外形图/Outline Drawings	7/8
11.更改记录/Records of Revisions	8/8

**1. 适用范围/General Scope of Application**

本说明书适用于扁平式永磁直流电机 C0827B059F 系列.

This specification applies to coin type permanent-magnetic motors DC model C0827B059F.

**2. 使用条件/Operating Conditions**

项目/Item	规格/Specifications	
2-1	额定电压 Rated voltage	3.0V DC
2-2	使用电压范围 Operating voltage	2.7~3.3V DC
2-3	旋转方向 Rotation	CW (clockwise) or CCW (counter clockwise)
2-4	使用环境 Operating environment	-20 ~ 60°C, 常湿/Ordinary Humidity:65±20%RH
2-5	保存环境 Storage environment	-30 ~ 70°C, 常湿/Ordinary Humidity:65±20%RH

**3. 测定条件/Conditions of Measurement**

项目/Item	规格/Specification	
3-1	温度 Temperature	25±3°C
3-2	湿度 Humidity	65±20% RH
3-3	电源电压 Power supply	稳压直流电源 3.0V。 Constant Power supply 3.0V DC.

**4. 电气性能/Electrical Characteristics**

项目/Item	规格/Specification	条件/Condition
4-1	额定转速 Rated speed	额定电压下。 At rated voltage.
4-2	额定电流 Rated current	
4-3	起动电流 Starting current	在最小起动电压下起动。 Motor is rotating at minimum starting voltage.
4-4	起动电压 Starting voltage	
4-5	绝缘电阻 Insulation resistance	在 100V 直流下, 导线和机壳间。 At DC 100V between lead wire and case.
4-6	端子阻抗 Terminal resistance	在 25°C 下。 At 25°C

## 5. 机械性能/Mechanical Characteristics

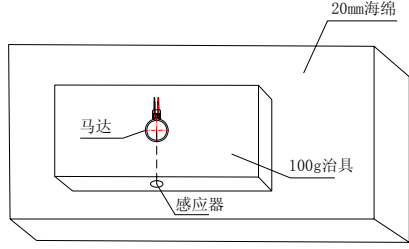
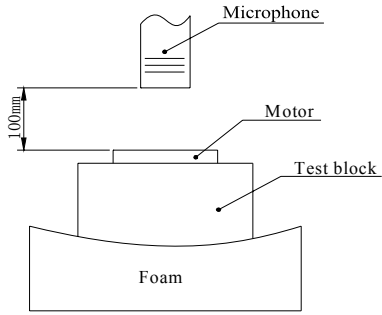
项目/Item	规格/Specification
5-1 底盖偏转强度 Bracket Deflection strength	9.8N 以上 9.8N or more.
5-2 测量模具/using dummy set (100g) 设备/equipment: PV-90B 感测器/sensor: VM-83 输入电压: 3.0V input voltage: 3.0V 振动量/Vibrations: 0.9G (Max)	
5-3 机械噪音 Mechanical noise	小于 50 分贝. A 计权 50dB (A) Max.
在额定电压下。At rated voltage. 背景噪音: 不大于 28dB. A 计权。 Back ground noise 28dB (A) Max.	

## 6. 耐久性能/ Reliability Tests

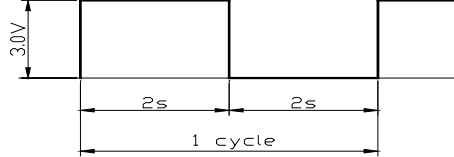
项目/Item	规格/Specification	判定标准/Judgment
6-1 寿命 Lifetime	额定电压/ Rated voltage: 3.0V DC 试验模式/ Test mode: 2s On, 2s Off, as one cycle. 循环次数/ Test cycle: 50,000 cycles 	试验后, 马达应符合项 7-1 的要求。After the test, motors shall be approved as specified in item 7-1.
6-2 低温放置 Low temperature exposure	温度/Temperature: $-30^{\circ}\text{C}$ 时间/Time: 96h	常温常湿下放置 4h 后, 马达应符合项 7-2 的要求。After 4 hours exposure in ordinary temperature and humidity, motors shall be approved as specified in item 7-2.
6-3 高温放置 High temperature Exposure	温度/Temperature: $+70^{\circ}\text{C}$ 时间/Time: 96h	常温常湿下放置 4h 后, 马达应符合项 7-2 的要求。After 4 hours exposure in ordinary temperature and humidity, motors shall be approved as specified in item 7-2.

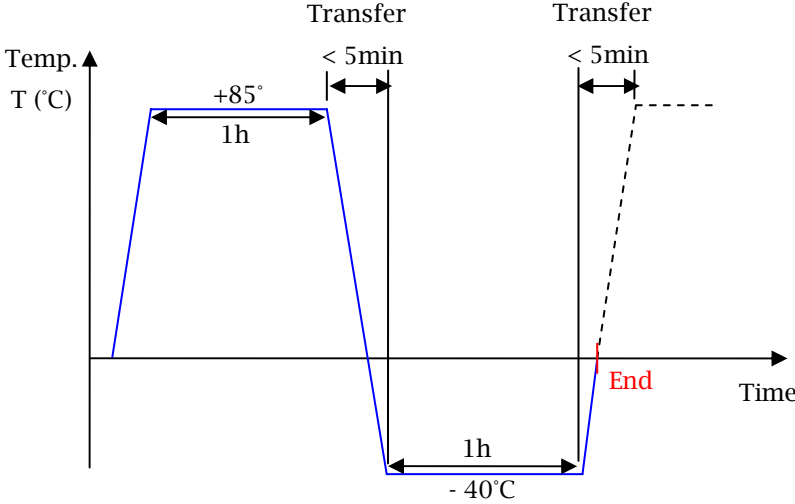
项目/Item	规格/Specification	判定标准/Judgment
6-4 湿度放置 High Humidity exposure	温度/Temperature: +40°C 湿度/Humidity: 95%RH 放置时间/ Exposure time: 96h 无水气凝结/ No condensation of moisture	常温常湿下放置 4h 后，马达应符合项 7-2 的要求。After 4 hours exposure in ordinary temperature and humidity, Motors shall be approved as specified in item 7-2.
6-5 振动 Vibration	全振幅/Displacement: 1.5mm (p-p) 频率/Frequency: 10~55Hz 加速度/Acceleration: 22m/s <sup>2</sup> 周期/Period: 10 分钟范围内 (10~55~10Hz)/ 10 Minutes log sweep (10~55~10Hz) 条件/Condition: 在样机中，在 3 个垂直的轴方向每个方向做 10 分钟的测试。Samples shall be applied for a period of 10 minutes in three axial directions.	测试结果应符合项 7-2 的要求。After the test motors shall be approved as specified in item 7-2.
6-6 自然跌落 Free fall	试验状态/Test mode: 将马达固定在约 100 克（包括马达本身）的物体上，落向水泥地面。Set the motor to a fixture of approx. 100g (include the motor) and drop it onto the concrete floor. 高度/Height: 1.5m 方向/Direction: ±x, ±y, ±z 次数/Number of times: 每个方向 3 次/ Each 3 times	测试结果应符合项 7-2 的要求。After the test motors shall be approved as specified in item 7-2.
6-7 热冲击 Thermal shock	测试模式/ Test mode: 1 hour at -40°C, 1 hour at +85°C, as one cycle. Transfer time between extreme temperatures: <5 分/5min 循环次数/Test cycle: 15 cycles 	常温常湿下放置 4h 后，马达应符合项 7-2 的要求。After 4 hours exposure in ordinary temperature and humidity, Motors shall be approved as specified in item 7-2.

## 7. 判定基准/ Judgments after Reliability Tests

项目/Item		判定基准 / Requirements
7-1	表 A Table A	1)额定转速/Rated speed: 不低于初始值-30%; 不高于初始值+50%/ No lower than -30% of initial data; No more than +50% of initial data. 2)额定电流/Rated current: 不低于初始值-30%; 不高于初始值+50% No lower than -30% of initial data; No more than +50% of initial data. 3)端阻/Terminal resistance: 不大于初始值±15% No more than +15% of initial data; No less than -15% of initial data. 4)起动电压/Starting voltage: 不大于 2.5V 直流电压 2.5V DC Max 5)绝缘电阻/Insulation resistance: 大于 10MΩ/ 10MΩ Min
7-2	表 B Table B	1)额定转速/Rated speed: 不大于初始值±20% No more than +20% of initial data; No less than -20% of initial data. 2)额定电流/Rated current: 不大于初始值±20% No more than +20% of initial data; No less than -20% of initial data. 3)起动电压/Starting voltage: 不大于 2.5V 直流电压 2.5V DC Max 4)端阻/Terminal resistance: 不大于初始值±15% No more than +15% of initial data; No less than -15% of initial data.

**8. 使用时注意事项/ Cautions for Use**

- 8-1 必须按照规格书标准使用，否则性能和寿命都将受到相当地减少，必须注意电压的使用范围。  
Unless it is used in accordance with the specifications, the performance and life may be considerably reduced. Due attention should be paid to voltage and range for use.
- 8-2 建议马达在六个月内使用，不要在以下环境中使用及保存：  
1. 高温和高湿的场所；  
2. 腐蚀性气体,如：H<sub>2</sub>S、SO<sub>2</sub>、NO<sub>2</sub>、Cl<sub>2</sub>；  
3. 生锈场所。  
Advice uses this motor within 6 months as avoiding as possible.  
Avoid use or save the motor in the following environment.  
1. High temperature and high humidity area  
2. Corrosive gas such as H<sub>2</sub>S, SO<sub>2</sub>, NO<sub>2</sub>, Cl<sub>2</sub>.  
3. Dusty area.
- 8-3 注意处理马达的工作环境，避免含铁质等物体被马达吸住，否则马达将会产生噪声，性能会降低，从而减少产品可靠性。  
Due attention must be paid to the handling and working environments because such objects as iron powder if attracted by the motor magnet, will cause noise, characteristic deterioration thus reducing the reliability.
- 8-4 应确信本产品不会与相关标准、法律、政令相背。  
Please confirm enough no problems of standards and laws and ordinances on your cellular phone.
- 8-5 拿马达时，要轻拿轻放。  
To handle the motor, hold the motor case softly.
- 8-6 钢板面或边缘有少许锈斑是允许的。  
Rust of plate (steel) and similar edge should be OK.
- 8-7 我司遵循持续发展的策略，在不预先通知的情况下，有对产品（部品）进行修改和改进的权利，当然这些都不会影响马达的特性及使用功能。  
Our company follows the sustainable developing strategy, and have the right to make changes and improvements to our product without giving notice in advance. Of course, these changes and improvements will not affect the characterisitics and function of the motor.



## 9. 包装/PACKING

### 扁平系列马达包装 Pack drawing of coin type

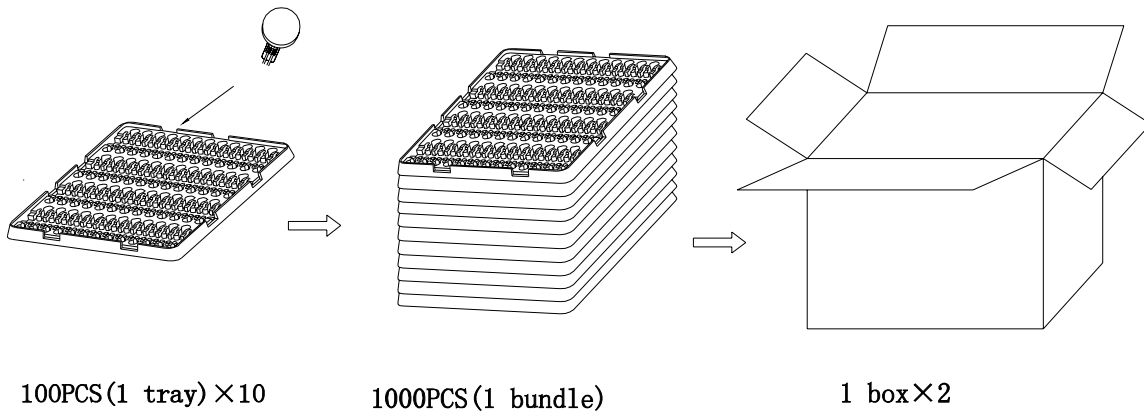
**Remarks:**

4000PCS/CTN: 45cm × 28cm × 20cm

6000PCS/CTN: 45cm × 28cm × 30cm

**包装试验要求:**

沿外包装箱±x, ±y和±z方向, 距水泥地面1.5m高度, 各自由跌落2次, 马达应无机械损伤, 电气性能仍符合标准要求。

**Drop Test with carton:**

Drop the carton in the axial directions of ±x, ±y, ±z onto the concrete floor from 1.5m height, drop twice each direction. After drop test, no mechanical damage to motors, and the electrical performances remain unchanged.

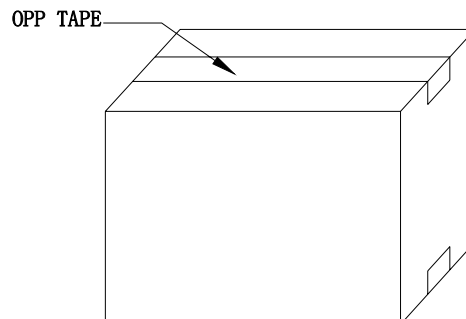

金龙机电股份有限公司  
技术开发部

Design Department JinLong  
Machinery & Electronics Co., Ltd.

10. 外形图/OUTLINE DRAWINGS

www.jinlong-machinery.com

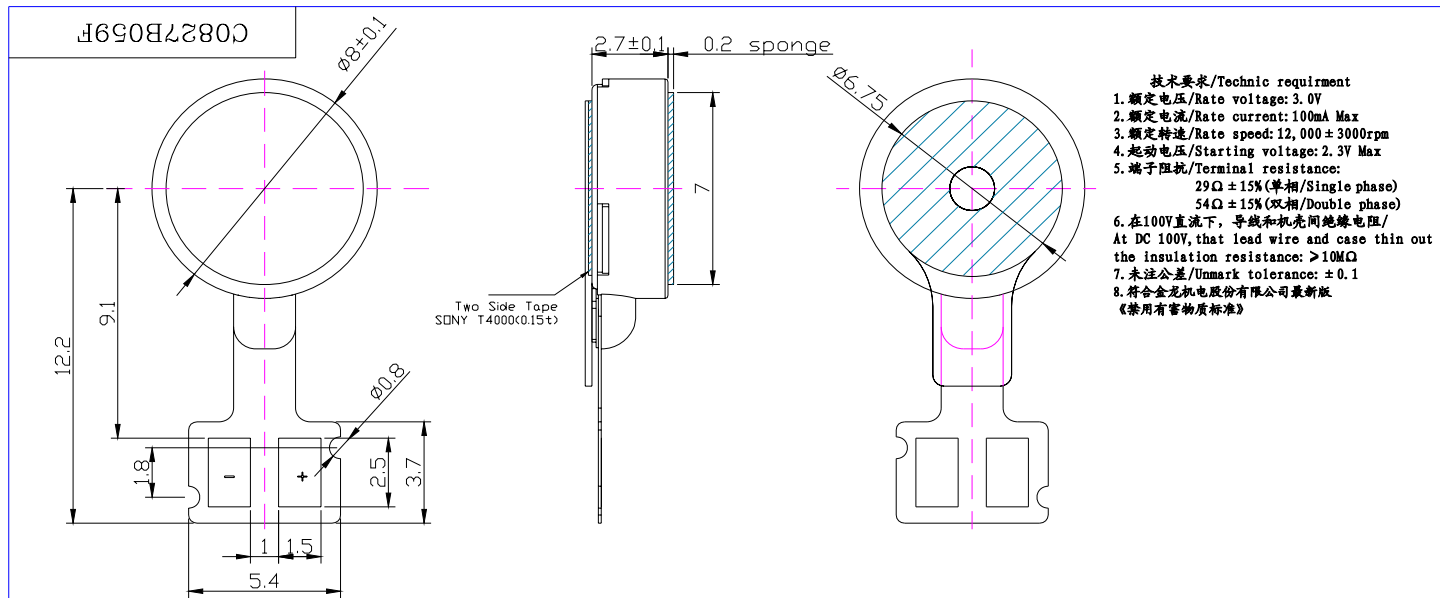

借(通)用件登记

底图总号

签字

日期

金龙标志 印字/MARK

马达型号 型号/MODEL

A	B	D	E	F	I	J	R	S	T	Q
1234	1227	1034	1030	1027	0834	1020	0830	0827	0825	1030 2V

生产线: ["1"表示"生产一线", 以此类推]

印字	1	2	3	4	5	6	7	8	9	A	B	C	D	E	F	G
日期	1	2	3	4	5	6	7	8	9	10	11	12	13	14	15	16
印字	H	J	K	L	M	N	P	Q	R	S	T	U	V	W	X	
日期	17	18	19	20	21	22	23	24	25	26	27	28	29	30	31	

日: 月: 年: [取末位数字(例如3表示2013年, 以此类推)]

KS1  
373

				jinlong-machinery.com				金龙机电股份有限公司		
								外形图		
标记	处数	分区	更改文件号	签名	日期	阶段标记	重量	比例		
设计	杨 兰	15.06.06	标准化	陈文荣	15.06.06		A/0	5:1	C0827B059F	
校对										
审核	黄 浦	15.06.06								
工艺			批准	黄剑辉	15.06.06	共 页	第 页			

