



Chipsmall Limited consists of a professional team with an average of over 10 year of expertise in the distribution of electronic components. Based in Hongkong, we have already established firm and mutual-benefit business relationships with customers from,Europe,America and south Asia,supplying obsolete and hard-to-find components to meet their specific needs.

With the principle of “Quality Parts,Customers Priority,Honest Operation,and Considerate Service”,our business mainly focus on the distribution of electronic components. Line cards we deal with include Microchip,ALPS,ROHM,Xilinx,Pulse,ON,Everlight and Freescale. Main products comprise IC,Modules,Potentiometer,IC Socket,Relay,Connector.Our parts cover such applications as commercial,industrial, and automotives areas.

We are looking forward to setting up business relationship with you and hope to provide you with the best service and solution. Let us make a better world for our industry!



Contact us

Tel: +86-755-8981 8866 Fax: +86-755-8427 6832

Email & Skype: info@chipsmall.com Web: www.chipsmall.com

Address: A1208, Overseas Decoration Building, #122 Zhenhua RD., Futian, Shenzhen, China



BARBARA-W

~35° wide beam

TECHNICAL SPECIFICATIONS:

Dimensions	Ø 70 mm
Height	44.7 mm
Fastening	glue
Colour	metal
Box size	476 x 273 x 247 mm
Box weight	5.7 kg
Quantity in Box	288 pcs
ROHS compliant	yes ⓘ



MATERIAL SPECIFICATIONS:

Component	Type	Material	Colour	Coating
BARBARA-W	Reflector	PC	metal	lacquer

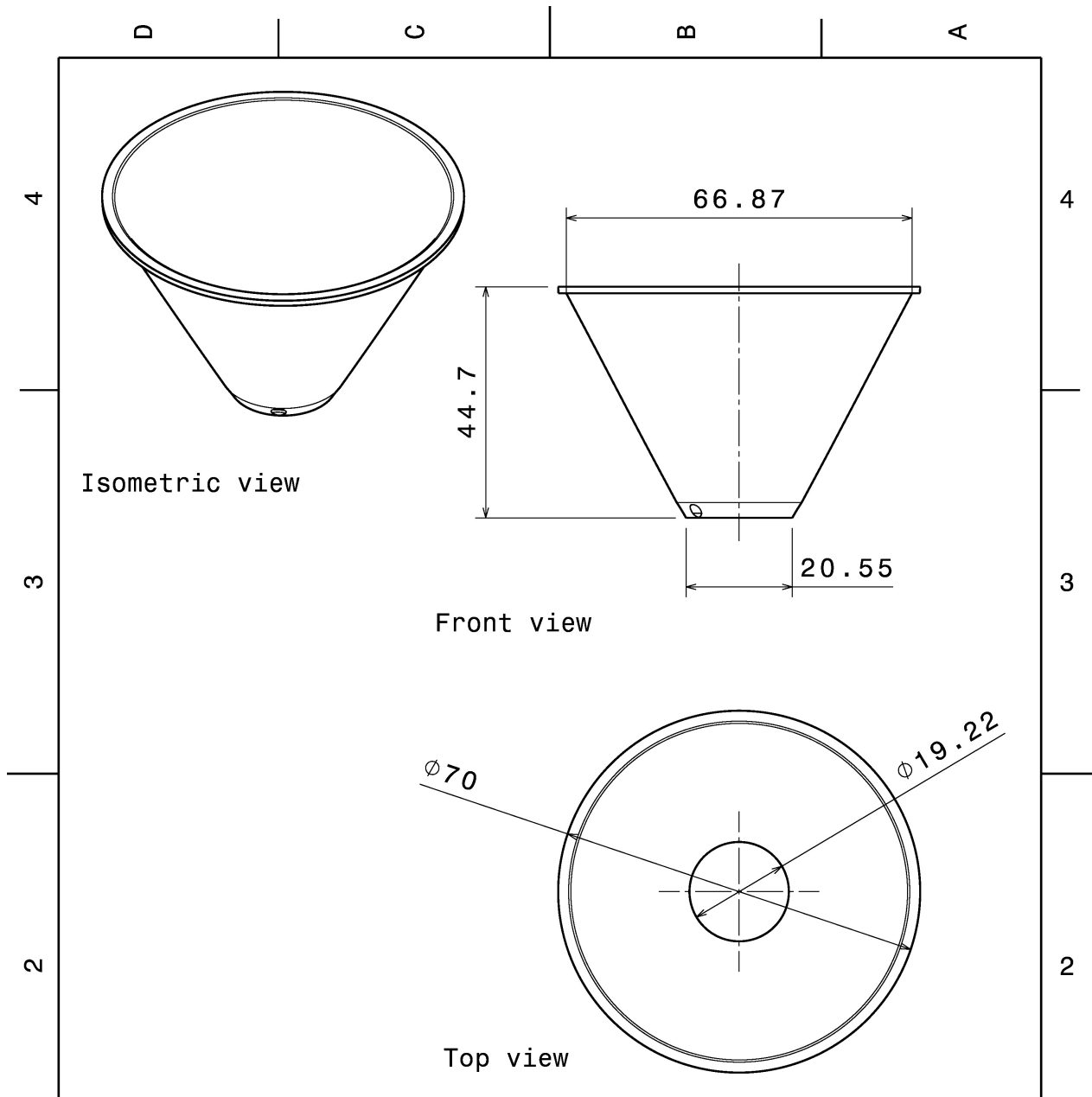

INDEX	DESCRIPTION	MATERIAL	COLOUR
1	Barbara reflector	PC	metal

Tolerances if not otherwise shown
According to DIN ISO 2768-1
Linear measures:
up to 30mm class M, otherwise class C
According to DIN ISO 2768-2
Form and position: class L



Ledil Oy
Salorankatu 10
FIN 24240 SALO
Finland

THIRD ANGLE PROJECTION:

DRAWING TITLE

Barbara series datasheet

This drawing is the property of LEDiL Oy. It may not be reproduced, copied or communicated without a written agreement with LEDiL Oy.

SIZE PART NUMBER

A4

-

SCALE 1:1 WEIGHT

-

SHEET 1/1

PHOTOMETRIC DATA (MEASURED):

bridgelux

LED BXRA ES Rectangle
FWHM 37.0°
Efficiency 90 %
Peak intensity 2.010 cd/lm
Required components:

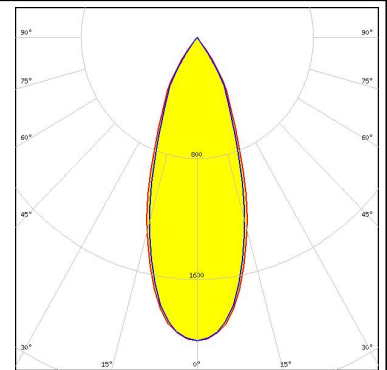

CITIZEN

LED CL-L330
FWHM 35.0°
Efficiency 90 %
Peak intensity 2.500 cd/lm
Required components:

CITIZEN

LED CLL03x/CLU03x
FWHM 42.0°
Efficiency 89 %
Peak intensity 1.800 cd/lm
Required components:

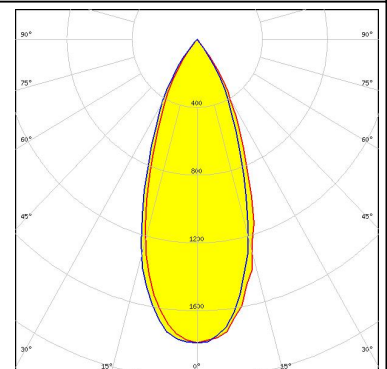

CITIZEN

LED CLU720/721
FWHM 35.0°
Efficiency 91 %
Peak intensity 2.000 cd/lm
Required components:

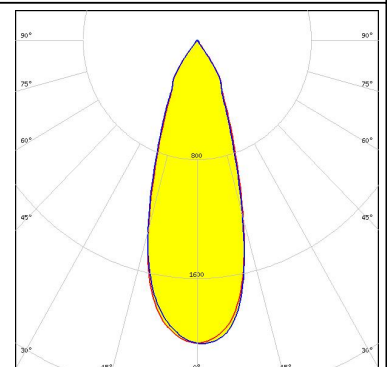
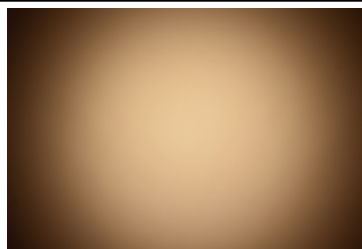

PHOTOMETRIC DATA (MEASURED):



LED CXA2011
FWHM 40.0°
Efficiency 90 %
Peak intensity 1.560 cd/lm
Required components:

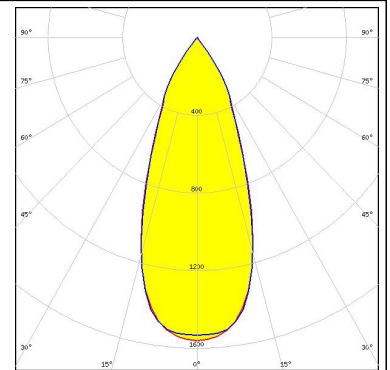

LED COB 10W/13W/17W/24W
FWHM 37.0°
Efficiency 89 %
Peak intensity 2.000 cd/lm
Required components:

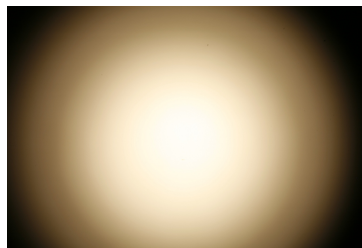

LED CXM-14
FWHM 41.0°
Efficiency 90 %
Peak intensity 1.700 cd/lm
Required components:

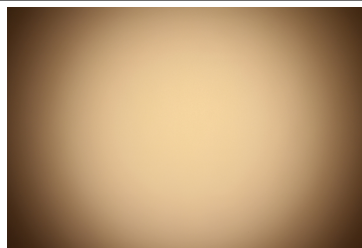

PHOTOMETRIC DATA (SIMULATED):

CITIZEN

LED CLU730/731
FWHM 37.0°
Efficiency 91 %
Peak intensity 1.960 cd/lm
Required components:

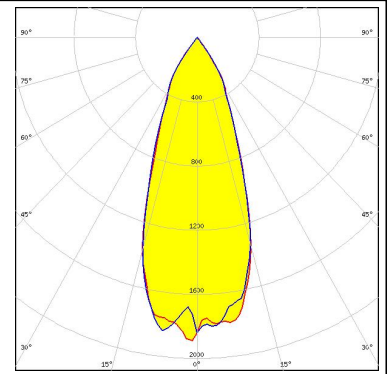

GENERAL INFORMATION:

NOTE: The typical beam angle will be changed by different color, chip size and chip position tolerance. The typical total beam angle is the full angle measured where the luminous intensity is half of the peak value.

Due to use of high power COB's with this product, special attention to proper thermal design is highly recommended. LEDiL has no liability for direct, indirect or consecutive damages arising from the LEDiL products being used outside of the recommended temperature range.

MATERIALS:

As part of our continuous research and improvement processes, and to ensure the best possible quality and availability of our products, LEDiL reserves the right to change material grades without notice.

PRODUCT DATA USER AGREEMENT AND DISCLAIMER:

The measured data in the provided downloadable LEDiL Product Datasheets and Mechanical 2D-Drawings is rounded and provided as reference for planning. LEDiL Oy's optical specifications have been verified by conducting performance testing of the products in accordance with the company's quality system. The reported data are averaged results of multiple measurements with typical variation. LEDiL Oy reserves the right to without prior notification make changes and improvements to its products.

LEDiL Oy assumes neither warranty, nor guarantee nor any other liability of any kind for the contents and correctness of the provided data. The provided data has been generated with highest diligence but the provided data may in reality not represent the complete possible variation range of all intrinsic parameters. Therefore, in certain cases a deviation from the provided data could occur.

LEDiL Oy reserves the right to undertake technical changes of its products without further notification which could lead to changes in the provided data. LEDiL Oy assumes no liability of any kind for the possible deviation from any provided data or any other damage resulting from the usage of the provided data.

The user agrees to this disclaimer and user agreement with the download or usage of the provided files.

LEDiL Oy

Joensuunkatu 13
FI-24240 SALO
Finland

LEDiL Inc.

228 West Page Street
Suite D
Sycamore IL 60178
USA

Local sales and technical support

[www.ledil.com/
where_to_buy](http://www.ledil.com/where_to_buy)

Shipping locations

Salo, Finland
Hong Kong, China

Distribution Partners

[www.ledil.com/
where_to_buy](http://www.ledil.com/where_to_buy)