



Chipsmall Limited consists of a professional team with an average of over 10 year of expertise in the distribution of electronic components. Based in Hongkong, we have already established firm and mutual-benefit business relationships with customers from,Europe,America and south Asia,supplying obsolete and hard-to-find components to meet their specific needs.

With the principle of “Quality Parts,Customers Priority,Honest Operation,and Considerate Service”,our business mainly focus on the distribution of electronic components. Line cards we deal with include Microchip,ALPS,ROHM,Xilinx,Pulse,ON,Everlight and Freescale. Main products comprise IC,Modules,Potentiometer,IC Socket,Relay,Connector.Our parts cover such applications as commercial,industrial, and automotives areas.

We are looking forward to setting up business relationship with you and hope to provide you with the best service and solution. Let us make a better world for our industry!



## Contact us

Tel: +86-755-8981 8866 Fax: +86-755-8427 6832

Email & Skype: info@chipsmall.com Web: www.chipsmall.com

Address: A1208, Overseas Decoration Building, #122 Zhenhua RD., Futian, Shenzhen, China



## MINNIE-M

~25° medium beam

### TECHNICAL SPECIFICATIONS:

Dimensions	Ø 32.4 mm
Height	14.8 mm
Fastening	glue
Colour	metal
Box size	480 x 280 x 300 mm
Box weight	4.4 kg
Quantity in Box	1080 pcs
ROHS compliant	yes ⓘ



### MATERIAL SPECIFICATIONS:

Component	Type	Material	Colour	Coating
MINNIE-M	Reflector	PC	metal	lacquer

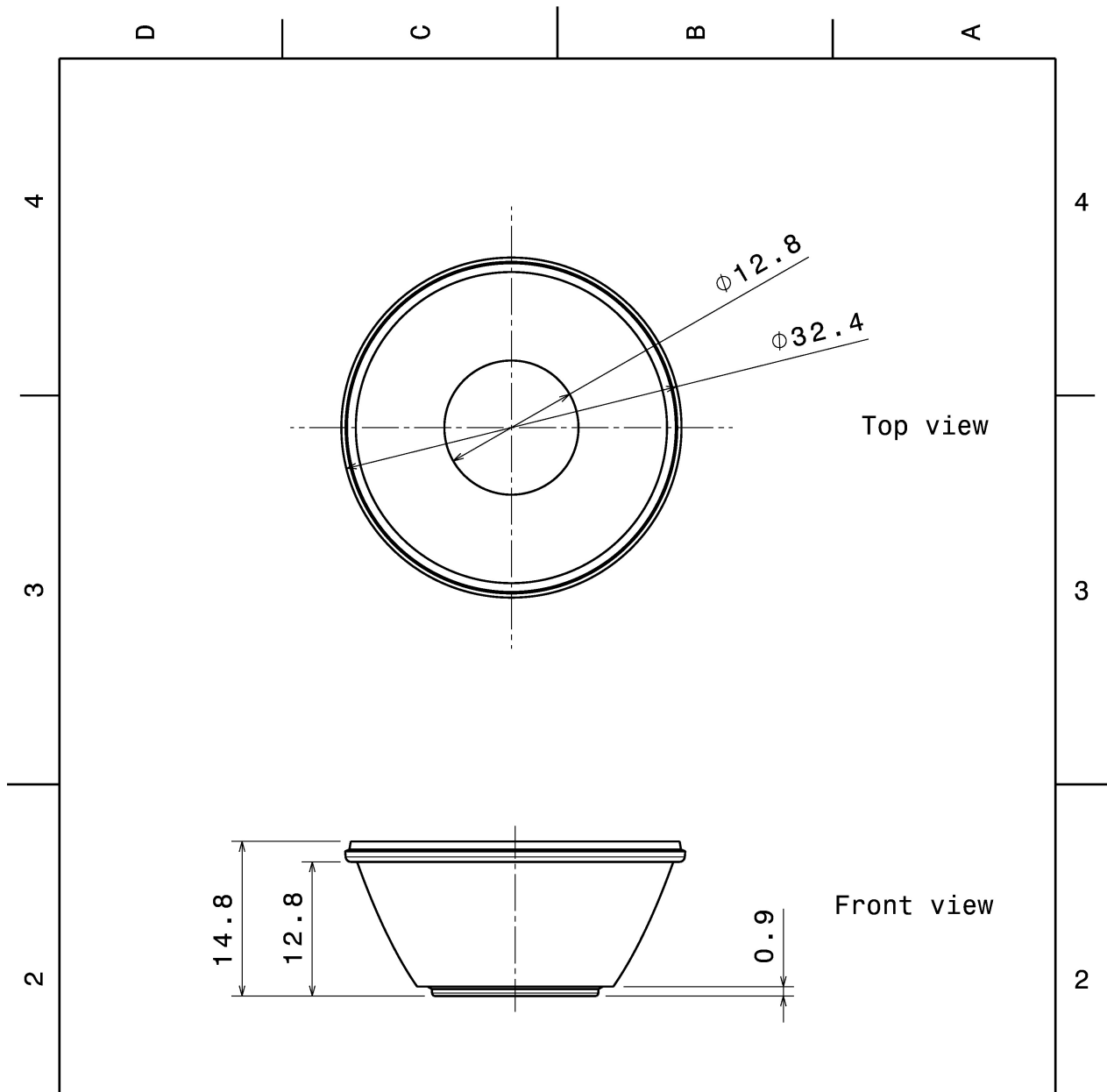

Version without holder,  
correct mounting height from the PCB 1,0 mm

Tolerances if not otherwise shown  
According to DIN ISO 2768-1  
Linear measures:  
Up to 30mm class M, otherwise class C.  
According to DIN ISO 2768-2  
Form and position: class L

**LEDiL** Oy  
Salorankatu 10  
FIN 24240 SALO  
Finland

THIRD ANGLE PROJECTION:

DRAWING TITLE  
**Datasheet Minnie**

This drawing is the property of LEDiL Oy. It may not be reproduced, copied or communicated without a written agreement with LEDiL Oy."

SIZE	PART NUMBER
A4	-

SCALE	2:1	WEIGHT	(g)	SHEET	1/1
-------	-----	--------	-----	-------	-----

D A

#### PHOTOMETRIC DATA (MEASURED):

**CREE** 

LED MHD-E/G  
 FWHM 23.0°  
 Efficiency 92 %  
 Peak intensity 2.500 cd/lm  
 Required components:

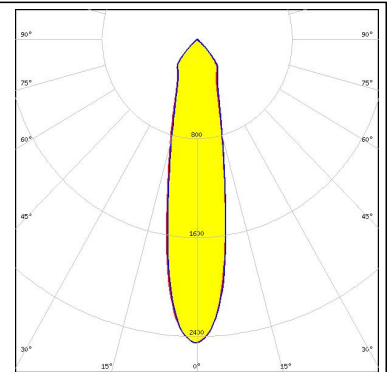
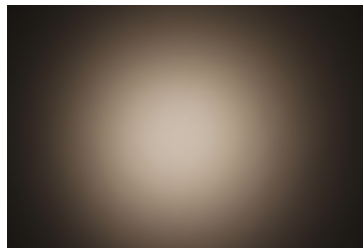

**CREE** 

LED MT-G  
 FWHM 26.0°  
 Efficiency 92 %  
 Peak intensity cd/lm  
 Required components:

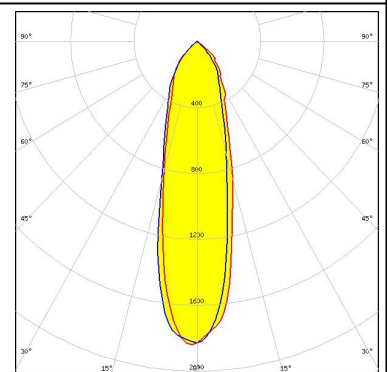
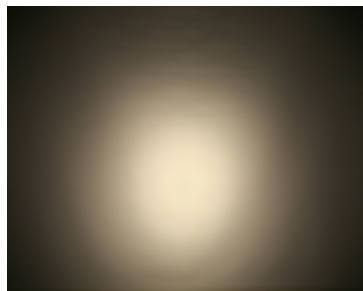

**CREE** 

LED XHP70  
 FWHM 23.0°  
 Efficiency 88 %  
 Peak intensity 2.500 cd/lm  
 Required components:

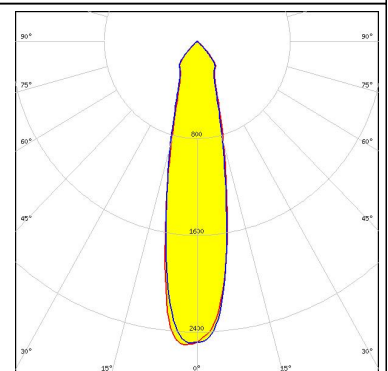
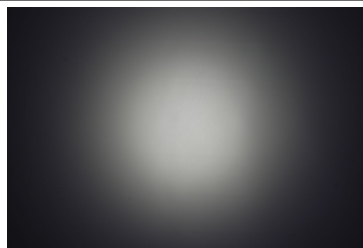

 **LUMILEDS**

LED LUXEON M/MX  
 FWHM 21.0°  
 Efficiency 90 %  
 Peak intensity 3.000 cd/lm  
 Required components:

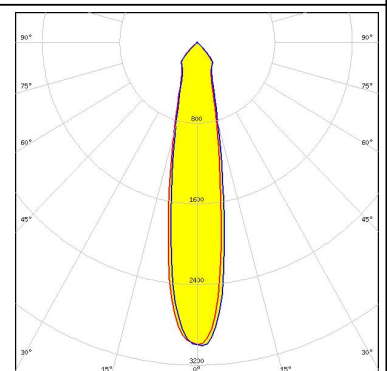

### PHOTOMETRIC DATA (MEASURED):



LED LUXEON MZ  
FWHM 14.0°  
Efficiency 87 %  
Peak intensity 6.100 cd/lm  
Required components:

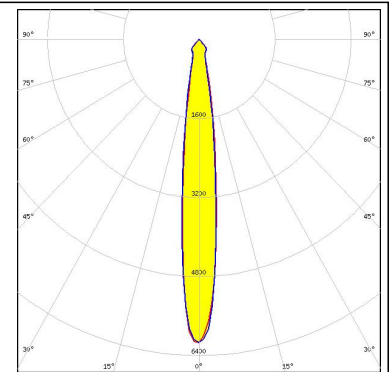

LED NSMx286M  
FWHM 18.0°  
Efficiency 91 %  
Peak intensity 3.750 cd/lm  
Required components:

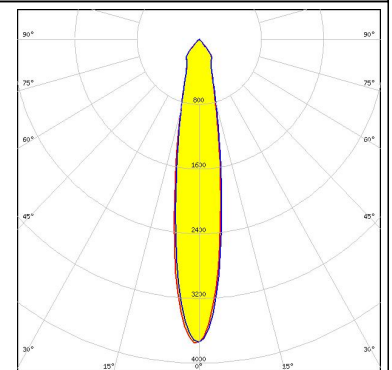
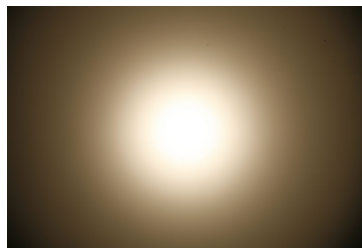

LED Duris S10  
FWHM 21.0°  
Efficiency 88 %  
Peak intensity 3.100 cd/lm  
Required components:

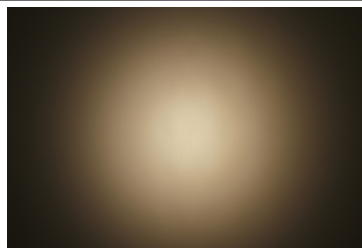

### PHOTOMETRIC DATA (SIMULATED):



LED LUXEON 5258  
FWHM 12.0°  
Efficiency 92 %  
Peak intensity 9.500 cd/lm  
Required components:



LED OSCONIQ P 7070  
FWHM 18.0°  
Efficiency 92 %  
Peak intensity 4.800 cd/lm  
Required components:

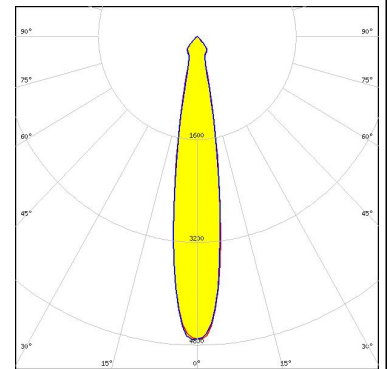

### GENERAL INFORMATION:

NOTE: The typical beam angle will be changed by different color, chip size and chip position tolerance. The typical total beam angle is the full angle measured where the luminous intensity is half of the peak value.

### MATERIALS:

As part of our continuous research and improvement processes, and to ensure the best possible quality and availability of our products, LEDiL reserves the right to change material grades without notice.

### PRODUCT DATA USER AGREEMENT AND DISCLAIMER:

The measured data in the provided downloadable LEDiL Product Datasheets and Mechanical 2D-Drawings is rounded and provided as reference for planning. LEDiL Oy's optical specifications have been verified by conducting performance testing of the products in accordance with the company's quality system. The reported data are averaged results of multiple measurements with typical variation. LEDiL Oy reserves the right to without prior notification make changes and improvements to its products.

LEDiL Oy assumes neither warranty, nor guarantee nor any other liability of any kind for the contents and correctness of the provided data. The provided data has been generated with highest diligence but the provided data may in reality not represent the complete possible variation range of all intrinsic parameters. Therefore, in certain cases a deviation from the provided data could occur.

LEDiL Oy reserves the right to undertake technical changes of its products without further notification which could lead to changes in the provided data. LEDiL Oy assumes no liability of any kind for the possible deviation from any provided data or any other damage resulting from the usage of the provided data.

The user agrees to this disclaimer and user agreement with the download or usage of the provided files.

#### LEDiL Oy

Joensuunkatu 13  
FI-24240 SALO  
Finland

#### LEDiL Inc.

228 West Page Street  
Suite D  
Sycamore IL 60178  
USA

#### Local sales and technical support

[www.ledil.com/  
where\\_to\\_buy](http://www.ledil.com/where_to_buy)

#### Shipping locations

Salo, Finland  
Hong Kong, China

#### Distribution Partners

[www.ledil.com/  
where\\_to\\_buy](http://www.ledil.com/where_to_buy)