



Chipsmall Limited consists of a professional team with an average of over 10 year of expertise in the distribution of electronic components. Based in Hongkong, we have already established firm and mutual-benefit business relationships with customers from,Europe,America and south Asia,supplying obsolete and hard-to-find components to meet their specific needs.

With the principle of "Quality Parts,Customers Priority,Honest Operation,and Considerate Service",our business mainly focus on the distribution of electronic components. Line cards we deal with include Microchip,ALPS,ROHM,Xilinx,Pulse,ON,Everlight and Freescale. Main products comprise IC,Modules,Potentiometer,IC Socket,Relay,Connector.Our parts cover such applications as commercial,industrial, and automotives areas.

We are looking forward to setting up business relationship with you and hope to provide you with the best service and solution. Let us make a better world for our industry!



Contact us

Tel: +86-755-8981 8866 Fax: +86-755-8427 6832

Email & Skype: info@chipsmall.com Web: www.chipsmall.com

Address: A1208, Overseas Decoration Building, #122 Zhenhua RD., Futian, Shenzhen, China



C&K C Series Power Rocker Switches



Features/Benefits

- Positive detent
- Attractive design
- Snap-in mounting

Typical Applications

- Floor care products
- Power outlet strips
- Small appliances



Specifications

CONTACT RATING: All Models: 15 AMPS @ 125 V AC; 10 AMPS @ 250 V AC . Models also available with see rating section.

ELECTRICAL LIFE: 10,000 make-and-break cycles at full load.

INSULATION RESISTANCE: $10^9 \Omega$ min.

DIELECTRIC STRENGTH: 2,500 Vrms min. @ sea level.

NOTE: Specifications and materials listed above are for switches with standard options. For information on specific and custom switches, consult Customer Service center.

Materials

HOUSING & ACTUATOR: 6/6 nylon (UL 94V-2), black (standard).

MOVABLE CONTACTS: Copper, silver plated.

STATIONARY CONTACT & TERMINALS:

C121, C122 models with 'QA' rating: Copper, silver plated.

C221, C222 models with 'QA' rating: Copper.

All models with 'QF' rating: Copper, silver plated.

CONTACT SPRING: Music wire or stainless steel.

Build-A-Switch

To order, simply select desired option from each category and place in the appropriate box. Available options are shown and described on pages G-69 and G-70. For additional options not shown in catalog, consult Customer Service Center.

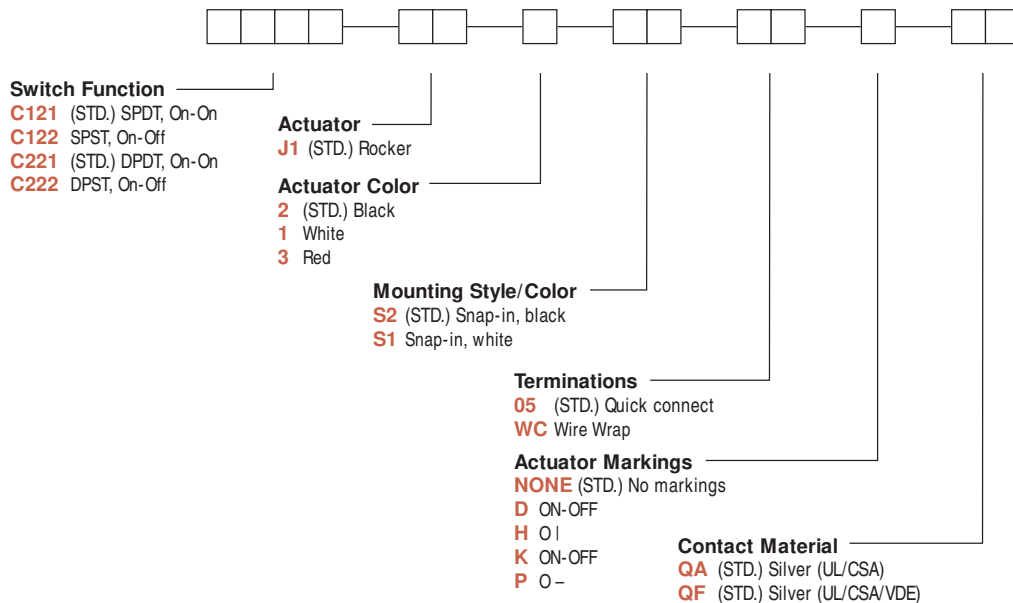

Rocker



G

C&K C Series Power Rocker Switches

SWITCH FUNCTION



NO. POLES	MODEL NO.	SWITCH FUNCTION		CONNECTED TERMINALS		SCHEMATIC		
		POS. 1	POS. 2	POS. 1	POS. 2			
SP	C121 (STD.)	ON	ON	2-1 1-1A	2-3 1-1B	SPDT		
	C122	ON	OFF	2-1 1-1A	OPEN	SPST		
DP	C221 (STD.)	ON	ON	1-1A, 2-2A	1-1B, 2-2B	DPDT		
	C222	ON	OFF	1-1A, 2-2A	OPEN	DPST		

SPDT

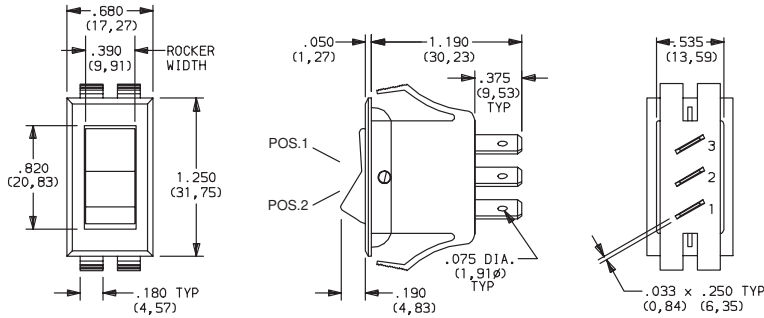

Part number shown: C121J12S205QF

TERM. NOS. FOR REFERENCE ONLY

All models with all options.

Only models with 'QF' rating meet international dimensional and electrical requirements .

Contacts make on side opposite actuator throw.

ACTUATOR

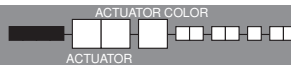

J1 (STD.) ROCKER

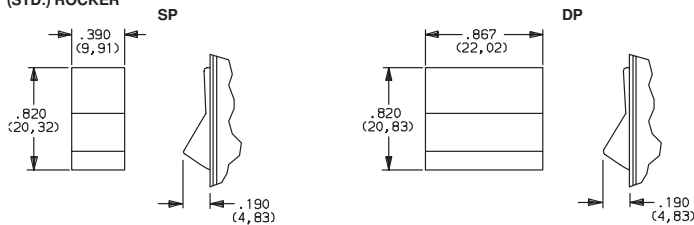

OPTION CODE	ACTUATOR COLOR
2	(STD.) BLACK
1	WHITE
3	RED

NOTE: Actuator finish: gloss (standard). Other colors available, consult Customer Service Center.

MOUNTING STYLE/COLOR



S1, S2 SNAP-IN

OPTION CODE	HOUSING COLOR
S2	(STD.) BLACK
S1	WHITE

NOTE: Frame finish on housing: gloss (standard). Other colors available, consult Customer Service Center.

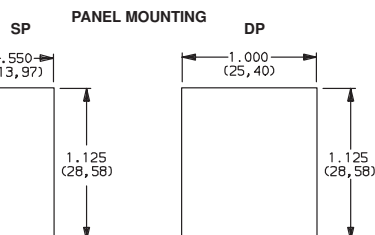

PANEL THICKNESS:
.020 (0,51) TO .200 (5,08)

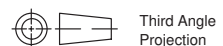

Third Angle Projection
Dimensions are shown: IN (mm)
Dimensions subject to change

Rocker

C&K C Series Power Rocker Switches

TERMINATIONS

05 (STD.) QUICK CONNECT

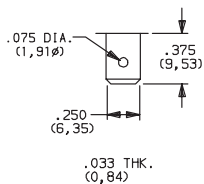

WC WIRE WRAP

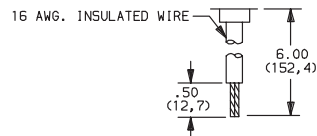

Available with 'QA' contact material only.
 (UL only) SP models only.
 Black wire standard, other colors and lengths available, consult Customer Service Center. UL style 1015.

ACTUATOR MARKINGS

NONE (STD.) NO MARKING



D ON-OFF

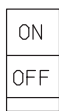

H O-I

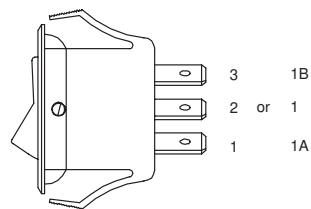

K ON-OFF



P O-

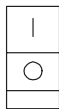

NOTE: Orientation of actuator markings and terminals.

'D, H, K & P' marking options: marking color white, standard for all actuator colors except white. Black, standard for white actuators. Consult Customer Service Center for other available markings and colors.

CONTACT MATERIAL

OPTION CODE	CONTACT AND TERMINAL MATERIAL	RATINGS	
		POWER	
QA (STD.)	SILVER ^{1,2}		15 AMPS @ 125 V AC; 10 AMPS @ 250 V AC (UL/CSA).
QF (STD.)			15 AMPS @ 125 V AC; 10 AMPS @ 250 V AC (UL/CSA/VDE).

CONTACT MATERIAL/APPLICATION RECOMMENDATIONS – SEE SECTION N.

¹ STATIONARY CONTACT & TERMINALS:
 All models with 'QA' rating: Copper, silver plated.
 All models with 'QF' rating: Copper, silver top lay.

² MOVABLE CONTACTS: Copper, silver plated.

All models .

Only models with 'QF' rating meet international dimensional and electrical requirements .

NOTE: 'QF' rating available with '05' terminations only.

