



Chipsmall Limited consists of a professional team with an average of over 10 year of expertise in the distribution of electronic components. Based in Hongkong, we have already established firm and mutual-benefit business relationships with customers from,Europe,America and south Asia,supplying obsolete and hard-to-find components to meet their specific needs.

With the principle of “Quality Parts,Customers Priority,Honest Operation,and Considerate Service”,our business mainly focus on the distribution of electronic components. Line cards we deal with include Microchip,ALPS,ROHM,Xilinx,Pulse,ON,Everlight and Freescale. Main products comprise IC,Modules,Potentiometer,IC Socket,Relay,Connector.Our parts cover such applications as commercial,industrial, and automotives areas.

We are looking forward to setting up business relationship with you and hope to provide you with the best service and solution. Let us make a better world for our industry!



Contact us

Tel: +86-755-8981 8866 Fax: +86-755-8427 6832

Email & Skype: info@chipsmall.com Web: www.chipsmall.com

Address: A1208, Overseas Decoration Building, #122 Zhenhua RD., Futian, Shenzhen, China



ANGIE-S

~12° spot beam

TECHNICAL SPECIFICATIONS:

Dimensions	Ø 34.0 mm
Height	10.7 mm
Fastening	glue, pin
Colour	clear
Box size	480 x 280 x 300 mm
Box weight	8.7 kg
Quantity in Box	1254 pcs
ROHS compliant	yes ⓘ



MATERIAL SPECIFICATIONS:

Component	Type	Material	Colour
ANGIE-S	Lens array	PMMA	clear

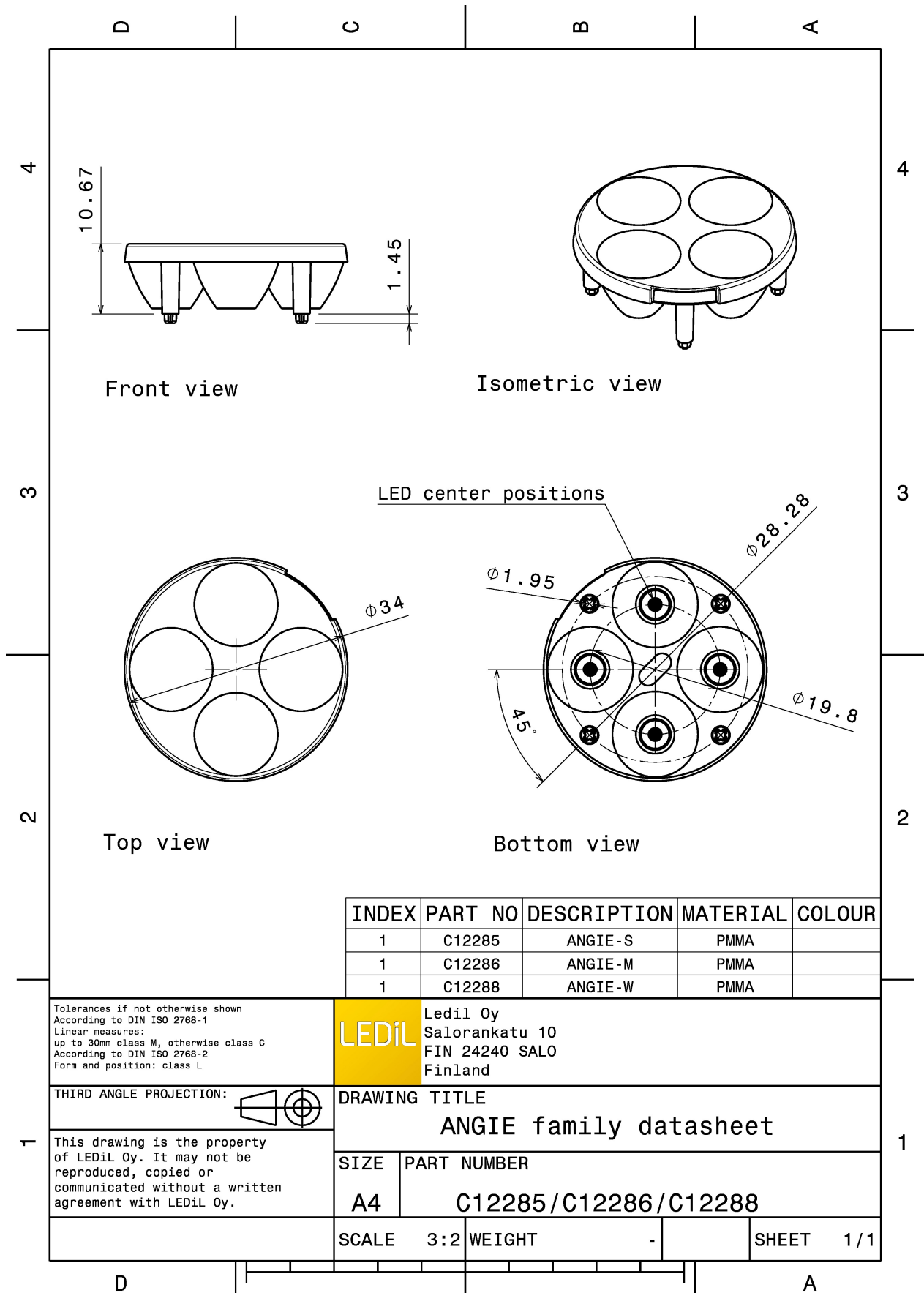

PHOTOMETRIC DATA (MEASURED):



LED XP-E
 FWHM 11.0°
 Efficiency 91 %
 Peak intensity 14.700 cd/lm
 Required components:



LED XP-G
 FWHM 15.0°
 Efficiency 93 %
 Peak intensity 8.020 cd/lm
 Required components:



LED LUXEON T
 FWHM 15.0°
 Efficiency 93 %
 Peak intensity 7.600 cd/lm
 Required components:

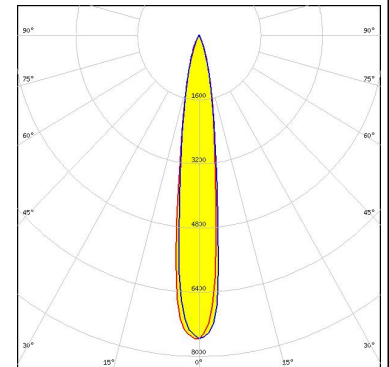
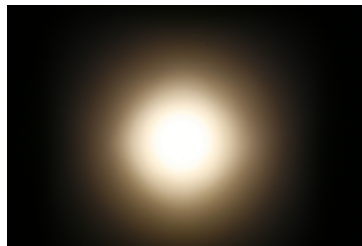

LED LUXEON TX
 FWHM 15.0°
 Efficiency 92 %
 Peak intensity 8.100 cd/lm
 Required components:

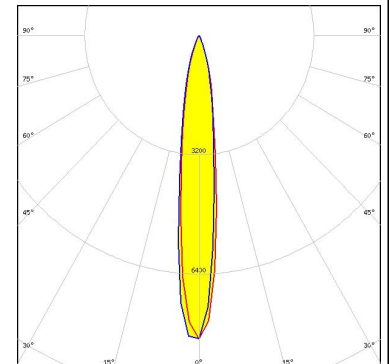
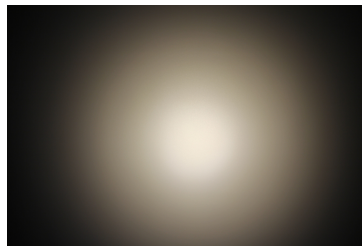

PHOTOMETRIC DATA (MEASURED):

OSRAM
Opto Semiconductors

LED Oslon Square EC
FWHM 14.0°
Efficiency 94 %
Peak intensity 8.300 cd/lm
Required components:

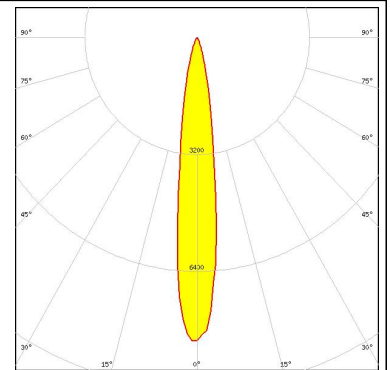

OSRAM
Opto Semiconductors

LED Oslon SSL 150
FWHM 10.0°
Efficiency 94 %
Peak intensity 17.000 cd/lm
Required components:

OSRAM
Opto Semiconductors

LED Oslon SSL 80
FWHM 12.0°
Efficiency 93 %
Peak intensity 11.000 cd/lm
Required components:

PHOTOMETRIC DATA (SIMULATED):



LED XP-L
 FWHM 21.0°
 Efficiency 91 %
 Peak intensity 4.600 cd/lm
 Required components:

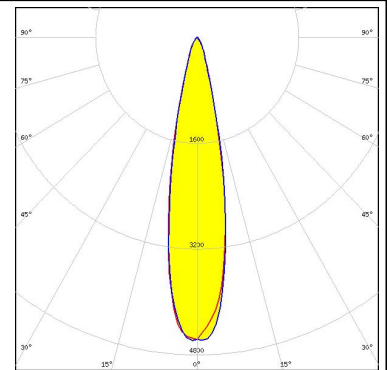

LED LUXEON H50-2
 FWHM 16.0°
 Efficiency 93 %
 Peak intensity 8.000 cd/lm
 Required components:

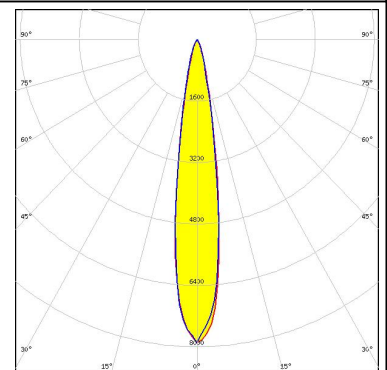

LED NVSxx19B/NVSxx19C
 FWHM 18.0°
 Efficiency 93 %
 Peak intensity 6.660 cd/lm
 Required components:

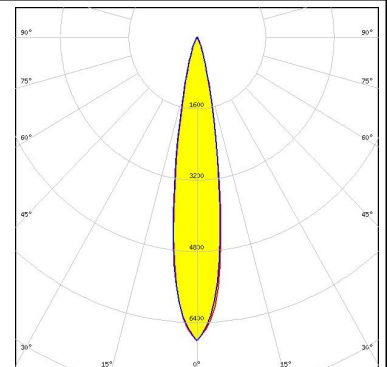

SEOUL SEMICONDUCTOR

LED Z5
 FWHM 10.0°
 Efficiency 92 %
 Peak intensity 19.000 cd/lm
 Required components:

PHOTOMETRIC DATA (SIMULATED):

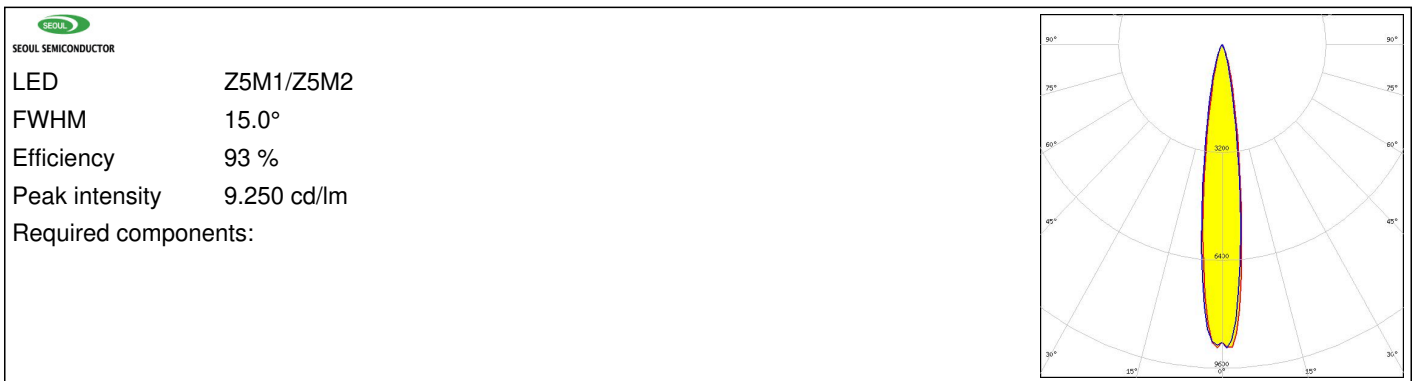

GENERAL INFORMATION:

NOTE: The typical beam angle will be changed by different color, chip size and chip position tolerance. The typical total beam angle is the full angle measured where the luminous intensity is half of the peak value.

MATERIALS:

As part of our continuous research and improvement processes, and to ensure the best possible quality and availability of our products, LEDiL reserves the right to change material grades without notice.

PRODUCT DATA USER AGREEMENT AND DISCLAIMER:

The measured data in the provided downloadable LEDiL Product Datasheets and Mechanical 2D-Drawings is rounded and provided as reference for planning. LEDiL Oy's optical specifications have been verified by conducting performance testing of the products in accordance with the company's quality system. The reported data are averaged results of multiple measurements with typical variation. LEDiL Oy reserves the right to without prior notification make changes and improvements to its products.

LEDiL Oy assumes neither warranty, nor guarantee nor any other liability of any kind for the contents and correctness of the provided data. The provided data has been generated with highest diligence but the provided data may in reality not represent the complete possible variation range of all intrinsic parameters. Therefore, in certain cases a deviation from the provided data could occur.

LEDiL Oy reserves the right to undertake technical changes of its products without further notification which could lead to changes in the provided data. LEDiL Oy assumes no liability of any kind for the possible deviation from any provided data or any other damage resulting from the usage of the provided data.

The user agrees to this disclaimer and user agreement with the download or usage of the provided files.

LEDiL Oy

Joensuunkatu 13
FI-24240 SALO
Finland

LEDiL Inc.

228 West Page Street
Suite D
Sycamore IL 60178
USA

Local sales and technical support

[www.ledil.com/
where_to_buy](http://www.ledil.com/where_to_buy)

Shipping locations

Salo, Finland
Hong Kong, China

Distribution Partners

[www.ledil.com/
where_to_buy](http://www.ledil.com/where_to_buy)