



Chipsmall Limited consists of a professional team with an average of over 10 year of expertise in the distribution of electronic components. Based in Hongkong, we have already established firm and mutual-benefit business relationships with customers from,Europe,America and south Asia,supplying obsolete and hard-to-find components to meet their specific needs.

With the principle of “Quality Parts,Customers Priority,Honest Operation,and Considerate Service”,our business mainly focus on the distribution of electronic components. Line cards we deal with include Microchip,ALPS,ROHM,Xilinx,Pulse,ON,Everlight and Freescale. Main products comprise IC,Modules,Potentiometer,IC Socket,Relay,Connector.Our parts cover such applications as commercial,industrial, and automotives areas.

We are looking forward to setting up business relationship with you and hope to provide you with the best service and solution. Let us make a better world for our industry!



## Contact us

Tel: +86-755-8981 8866 Fax: +86-755-8427 6832

Email & Skype: info@chipsmall.com Web: www.chipsmall.com

Address: A1208, Overseas Decoration Building, #122 Zhenhua RD., Futian, Shenzhen, China



## SATU-S

~19° spot beam optimized for CREE XT-E

### TECHNICAL SPECIFICATIONS:

Dimensions	Ø 21.8 mm
Height	8.9 mm
Fastening	glue, pin
Colour	clear
Box size	480 x 280 x 300 mm
Box weight	7.7 kg
Quantity in Box	2880 pcs
ROHS compliant	yes ⓘ



### MATERIAL SPECIFICATIONS:

Component	Type	Material	Colour
SATU-S	Lens array	PMMA	clear

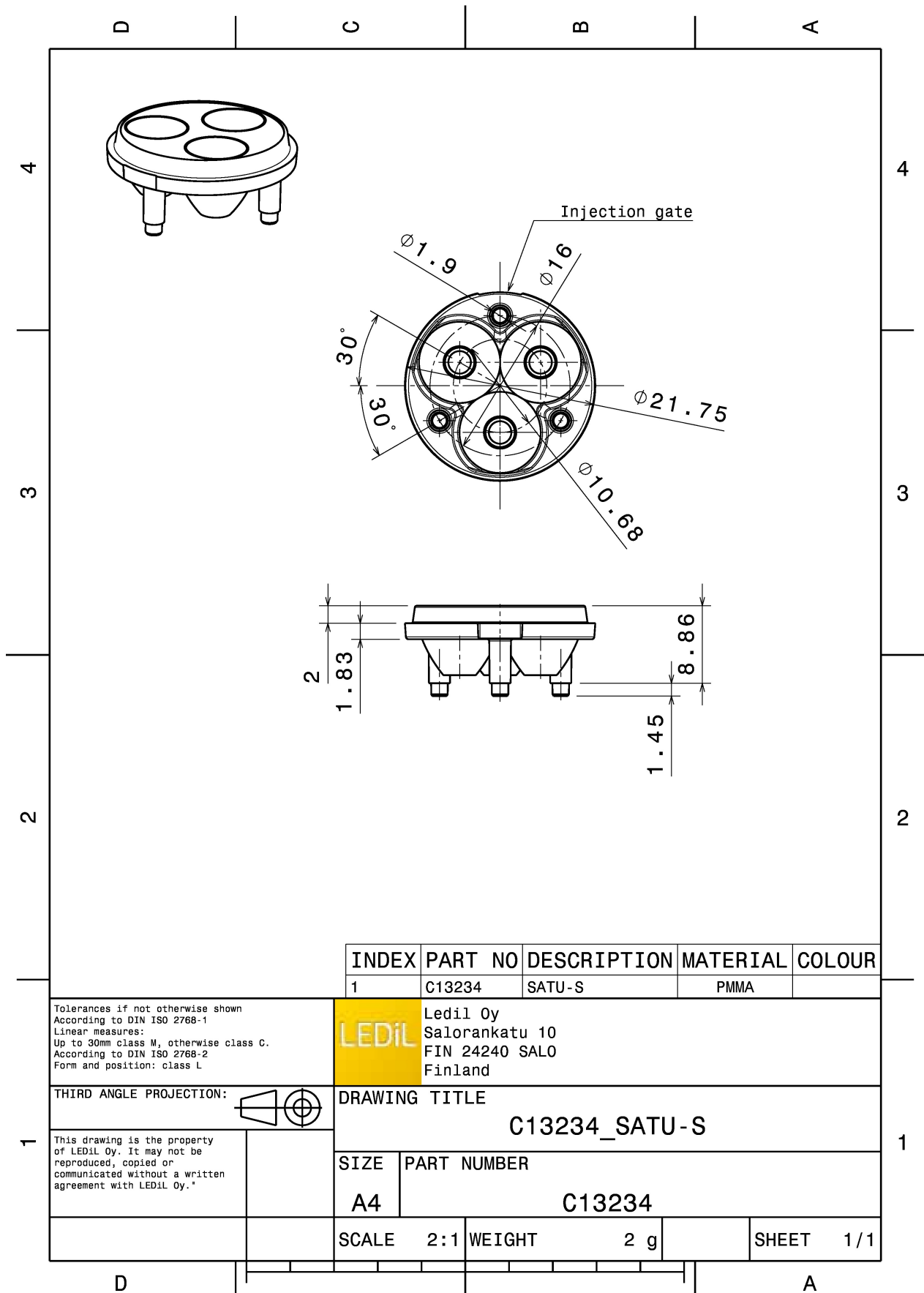



## PHOTOMETRIC DATA (MEASURED):

### CREE

LED XB-D  
FWHM 21.0°  
Efficiency 80 %  
Peak intensity 3.500 cd/lm  
Required components:



### CREE

LED XP-E  
FWHM 20.0°  
Efficiency 85 %  
Peak intensity 4.600 cd/lm  
Required components:

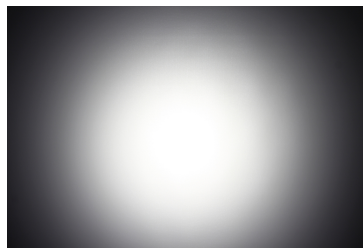

### CREE

LED XP-E2  
FWHM 20.0°  
Efficiency 86 %  
Peak intensity 5.500 cd/lm  
Required components:

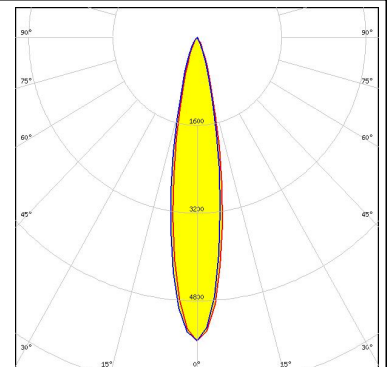
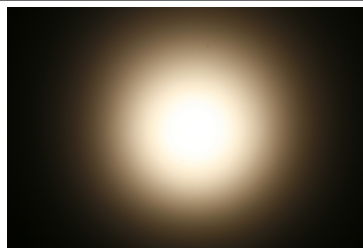

### CREE

LED XP-G  
FWHM 25.0°  
Efficiency 83 %  
Peak intensity 2.900 cd/lm  
Required components:

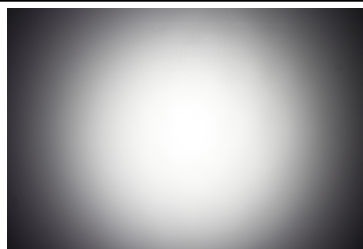

#### PHOTOMETRIC DATA (MEASURED):



LED XP-G2  
 FWHM 26.0°  
 Efficiency 85 %  
 Peak intensity 3.300 cd/lm  
 Required components:

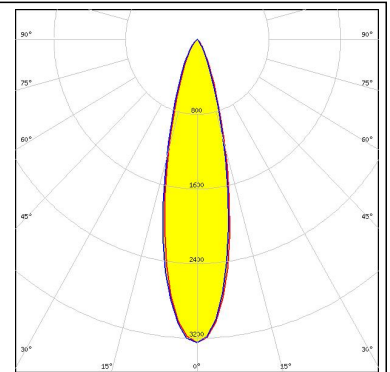

LED XT-E  
 FWHM 24.0°  
 Efficiency 89 %  
 Peak intensity 3.400 cd/lm  
 Required components:

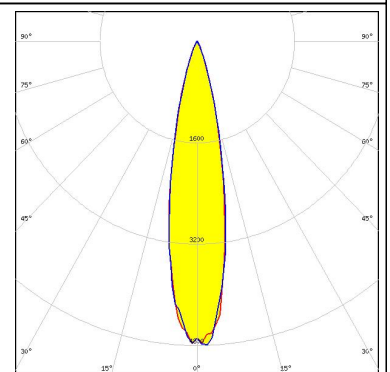

LED H35B0 (LEMWA32)  
 FWHM 24.0°  
 Efficiency 82 %  
 Peak intensity 3.200 cd/lm  
 Required components:

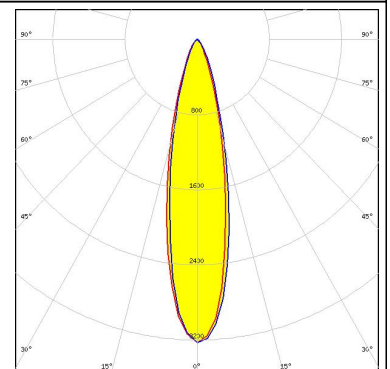
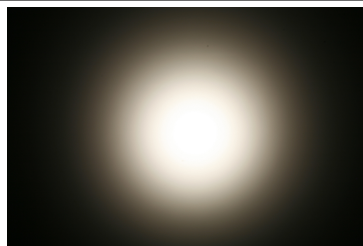

LED H35C0 (LEMWA33)  
 FWHM 27.0°  
 Efficiency 86 %  
 Peak intensity 2.800 cd/lm  
 Required components:

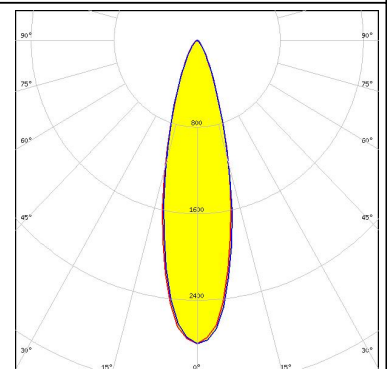
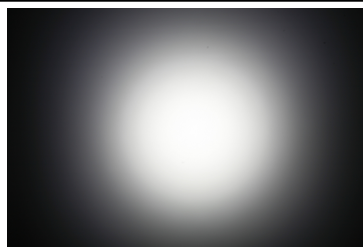

#### PHOTOMETRIC DATA (MEASURED):



LED LUXEON T  
 FWHM 27.0°  
 Efficiency 88 %  
 Peak intensity 2.700 cd/lm  
 Required components:

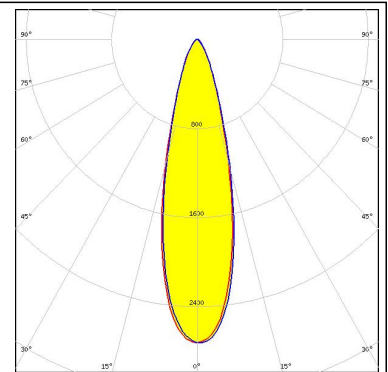

LED LUXEON TX  
 FWHM 26.0°  
 Efficiency 86 %  
 Peak intensity 2.800 cd/lm  
 Required components:

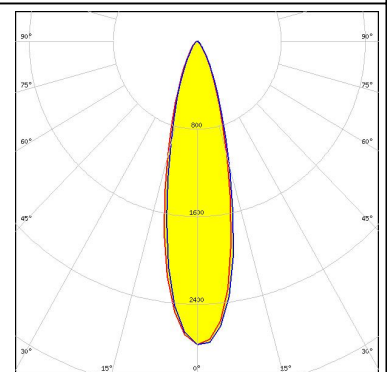
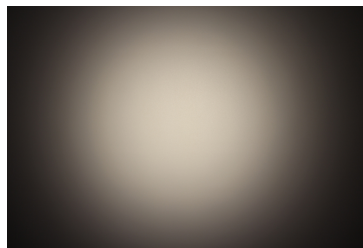

LED NF2x757A  
 FWHM 23.0°  
 Efficiency 85 %  
 Peak intensity 2.800 cd/lm  
 Required components:

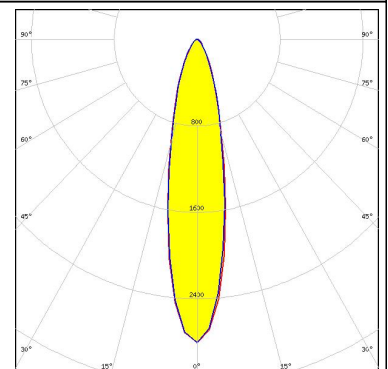
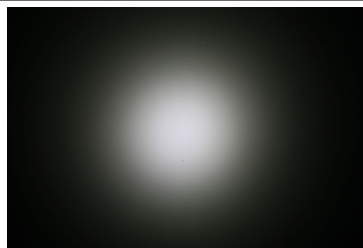

LED Oslon Square EC  
 FWHM 24.0°  
 Efficiency 85 %  
 Peak intensity 3.200 cd/lm  
 Required components:

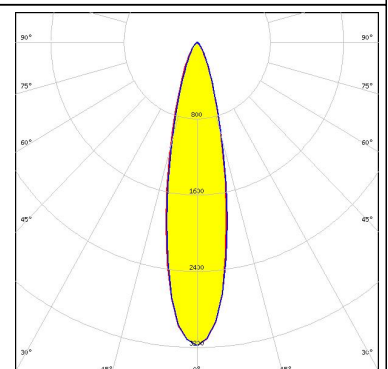

## PHOTOMETRIC DATA (MEASURED):

**OSRAM**  
Opto Semiconductors

LED Oslon SSL 80  
FWHM 18.0°  
Efficiency 81 %  
Peak intensity 4.400 cd/lm  
Required components:

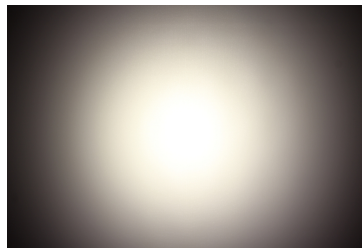

**SAMSUNG**

LED LH351Z  
FWHM 24.0°  
Efficiency 87 %  
Peak intensity 3.400 cd/lm  
Required components:

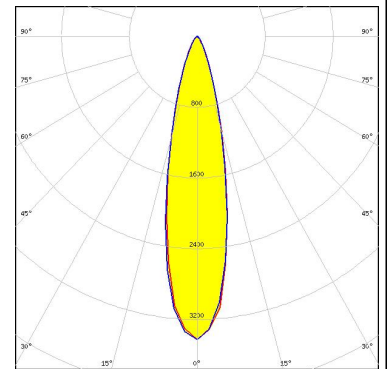
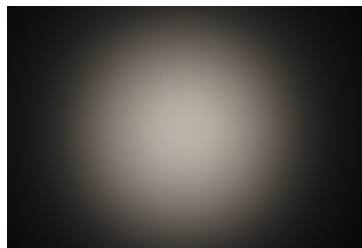

### PHOTOMETRIC DATA (SIMULATED):



LED LUXEON H50-2  
 FWHM 24.0°  
 Efficiency 90 %  
 Peak intensity 4.000 cd/lm  
 Required components:

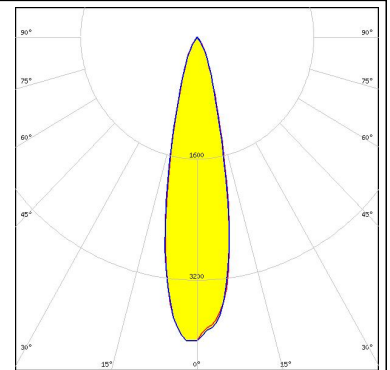

LED NVSxx19B/NVSxx19C  
 FWHM 26.0°  
 Efficiency 87 %  
 Peak intensity 3.130 cd/lm  
 Required components:

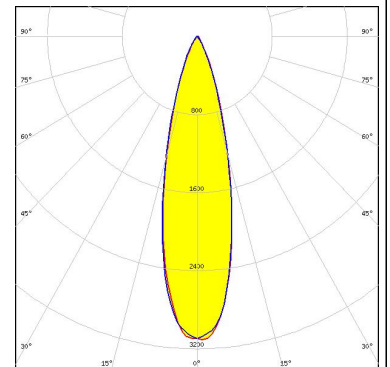

LED Synios P2720 1/2 mm  
 FWHM 16.0°  
 Efficiency 94 %  
 Peak intensity 7.890 cd/lm  
 Required components:

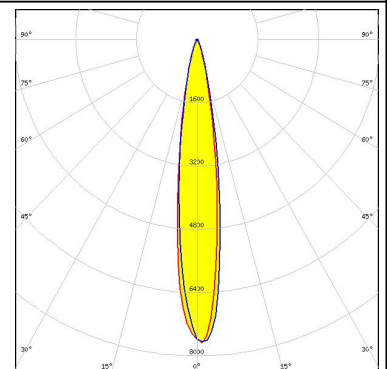

LED Z8Y22P  
 FWHM 27.0°  
 Efficiency 87 %  
 Peak intensity 2.690 cd/lm  
 Required components:

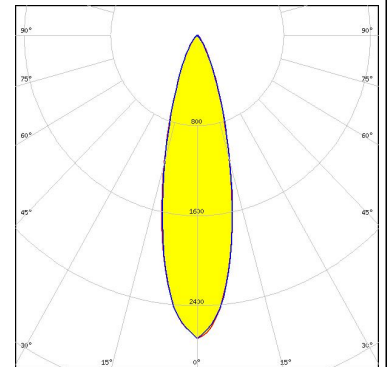



### GENERAL INFORMATION:

NOTE: The typical beam angle will be changed by different color, chip size and chip position tolerance. The typical total beam angle is the full angle measured where the luminous intensity is half of the peak value.

### MATERIALS:

As part of our continuous research and improvement processes, and to ensure the best possible quality and availability of our products, LEDiL reserves the right to change material grades without notice.

### PRODUCT DATA USER AGREEMENT AND DISCLAIMER:

The measured data in the provided downloadable LEDiL Product Datasheets and Mechanical 2D-Drawings is rounded and provided as reference for planning. LEDiL Oy's optical specifications have been verified by conducting performance testing of the products in accordance with the company's quality system. The reported data are averaged results of multiple measurements with typical variation. LEDiL Oy reserves the right to without prior notification make changes and improvements to its products.

LEDiL Oy assumes neither warranty, nor guarantee nor any other liability of any kind for the contents and correctness of the provided data. The provided data has been generated with highest diligence but the provided data may in reality not represent the complete possible variation range of all intrinsic parameters. Therefore, in certain cases a deviation from the provided data could occur.

LEDiL Oy reserves the right to undertake technical changes of its products without further notification which could lead to changes in the provided data. LEDiL Oy assumes no liability of any kind for the possible deviation from any provided data or any other damage resulting from the usage of the provided data.

The user agrees to this disclaimer and user agreement with the download or usage of the provided files.

#### LEDiL Oy

Joensuunkatu 13  
FI-24240 SALO  
Finland

#### LEDiL Inc.

228 West Page Street  
Suite D  
Sycamore IL 60178  
USA

#### Local sales and technical support

[www.ledil.com/  
where\\_to\\_buy](http://www.ledil.com/where_to_buy)

#### Shipping locations

Salo, Finland  
Hong Kong, China

#### Distribution Partners

[www.ledil.com/  
where\\_to\\_buy](http://www.ledil.com/where_to_buy)