



Chipsmall Limited consists of a professional team with an average of over 10 year of expertise in the distribution of electronic components. Based in Hongkong, we have already established firm and mutual-benefit business relationships with customers from,Europe,America and south Asia,supplying obsolete and hard-to-find components to meet their specific needs.

With the principle of “Quality Parts,Customers Priority,Honest Operation,and Considerate Service”,our business mainly focus on the distribution of electronic components. Line cards we deal with include Microchip,ALPS,ROHM,Xilinx,Pulse,ON,Everlight and Freescale. Main products comprise IC,Modules,Potentiometer,IC Socket,Relay,Connector.Our parts cover such applications as commercial,industrial, and automotives areas.

We are looking forward to setting up business relationship with you and hope to provide you with the best service and solution. Let us make a better world for our industry!



Contact us

Tel: +86-755-8981 8866 Fax: +86-755-8427 6832

Email & Skype: info@chipsmall.com Web: www.chipsmall.com

Address: A1208, Overseas Decoration Building, #122 Zhenhua RD., Futian, Shenzhen, China



STRADA-2X2-PX

Fully asymmetric beam designed to highlight pedestrian crossings for right side traffic

TECHNICAL SPECIFICATIONS:

Dimensions	50.0 mm
Height	8 mm
Fastening	screw, pin
Colour	clear
Box size	480 x 280 x 300 mm
Box weight	7.9 kg
Quantity in Box	800 pcs
ROHS compliant	yes ⓘ



MATERIAL SPECIFICATIONS:

Component	Type	Material	Colour
STRADA-2X2-PX	Lens	PMMA	clear

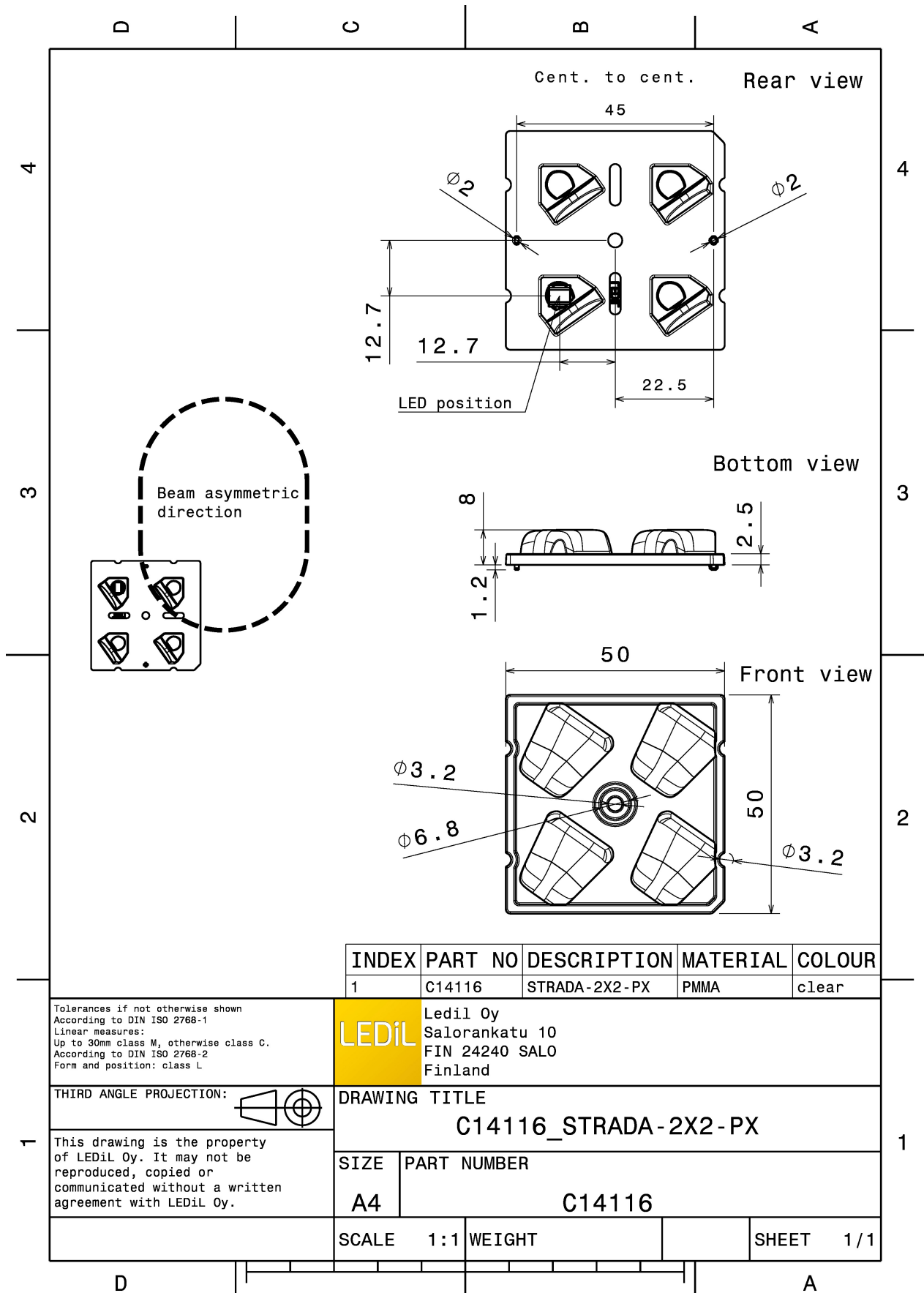

INDEX	PART NO	DESCRIPTION	MATERIAL	COLOUR
1	C14116	STRADA-2X2-PX	PMMA	clear

Tolerances if not otherwise shown
According to DIN ISO 2768-1
Linear measures:
Up to 30mm class M, otherwise class C.
According to DIN ISO 2768-2
Form and position: class L



Ledil Oy
Salorankatu 10
FIN 24240 SALO
Finland

THIRD ANGLE PROJECTION:

DRAWING TITLE

C14116_STRADA-2X2-PX

This drawing is the property of LEDiL Oy. It may not be reproduced, copied or communicated without a written agreement with LEDiL Oy.

SIZE PART NUMBER

A4

C14116

SCALE 1:1 WEIGHT

SHEET 1/1

PHOTOMETRIC DATA (MEASURED):



LED QUICK FLUX XTP 2x4 xxx LS G5
 FWHM Asymmetric
 Efficiency 94 %
 Peak intensity 1.000 cd/lm
 Required components:

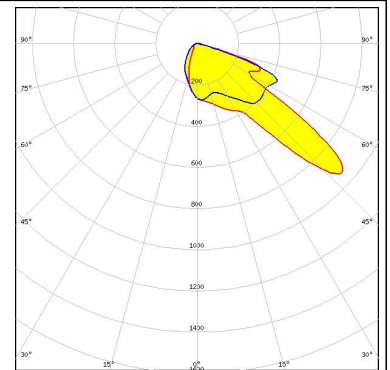

LED QUICK FLUX XTP 2x6 xxx LS G5
 FWHM Asymmetric
 Efficiency 94 %
 Peak intensity 1.000 cd/lm
 Required components:

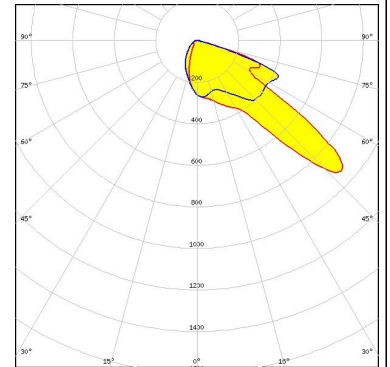

LED QUICK FLUX XTP 2x8 xxx LS G5
 FWHM Asymmetric
 Efficiency 94 %
 Peak intensity 0.760 cd/lm
 Required components:

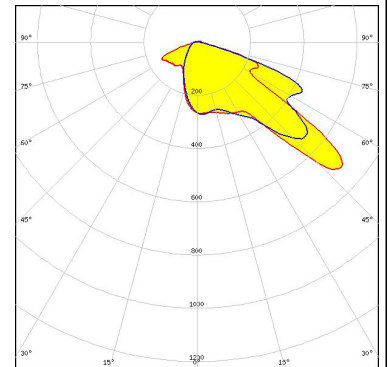

LED XB-D
 FWHM Asymmetric
 Efficiency 94 %
 Peak intensity 1.000 cd/lm
 Required components:

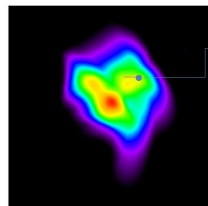

Light at plane, note LENS rotation shown upright.

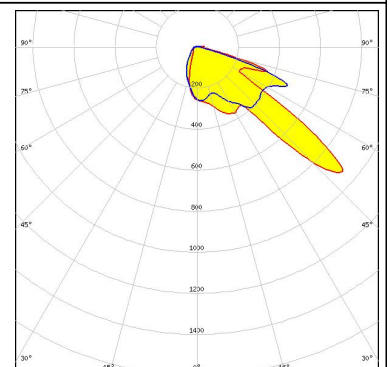

PHOTOMETRIC DATA (MEASURED):



LED XB-H
 FWHM Asymmetric
 Efficiency 94 %
 Peak intensity 1.000 cd/lm
 Required components:

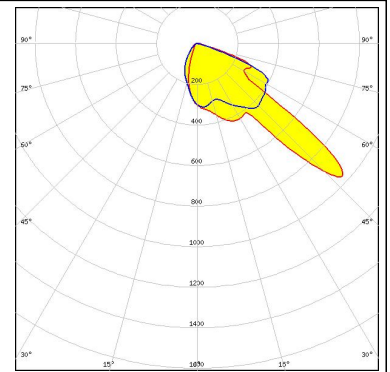
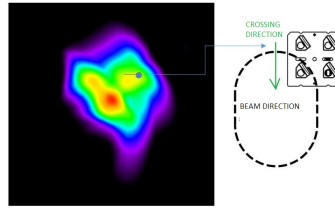

LED XM-L
 FWHM Asymmetric
 Efficiency 94 %
 Peak intensity 0.770 cd/lm
 Required components:

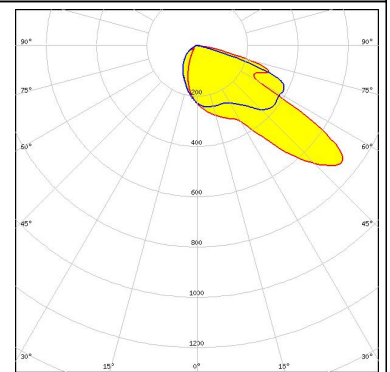

LED XM-L2
 FWHM Asymmetric
 Efficiency 94 %
 Peak intensity 0.790 cd/lm
 Required components:

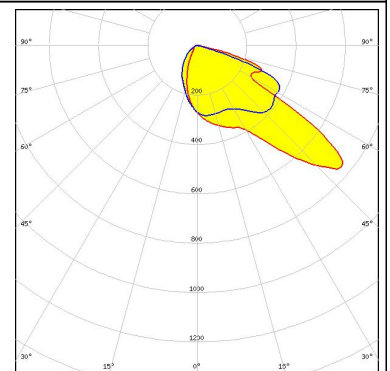
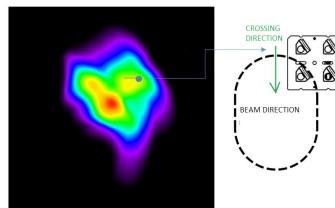

LED XP-E
 FWHM Asymmetric
 Efficiency 94 %
 Peak intensity 1.200 cd/lm
 Required components:

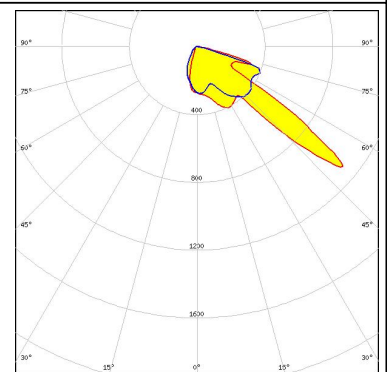
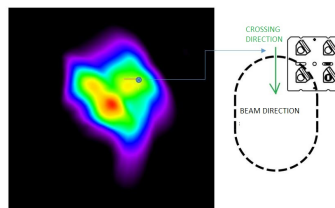

PHOTOMETRIC DATA (MEASURED):



LED XP-E2
 FWHM Asymmetric
 Efficiency 94 %
 Peak intensity 1.200 cd/lm
 Required components:

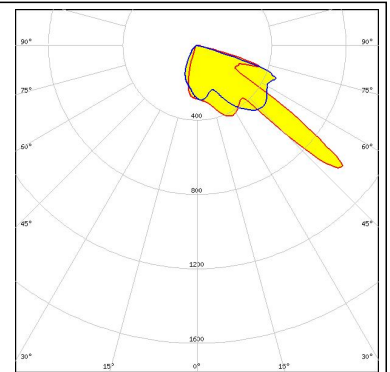
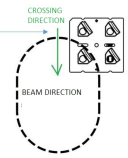
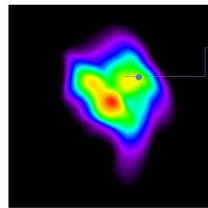

LED XP-G
 FWHM Asymmetric
 Efficiency 94 %
 Peak intensity 1.000 cd/lm
 Required components:

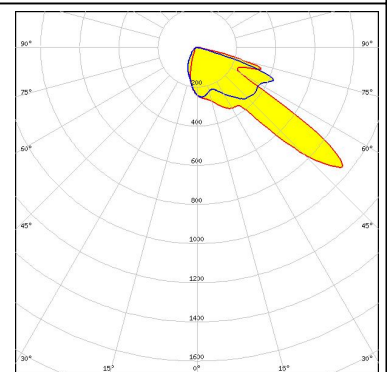
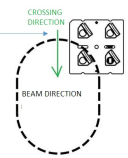
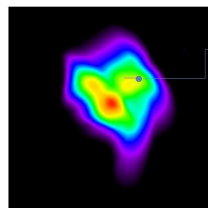

LED XP-G2
 FWHM Asymmetric
 Efficiency 94 %
 Peak intensity 1.000 cd/lm
 Required components:

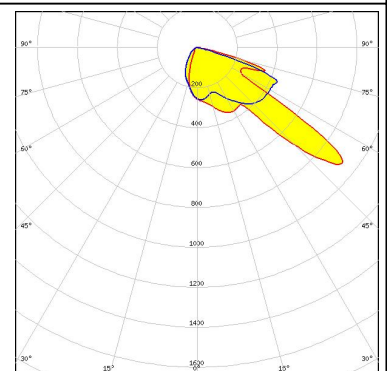
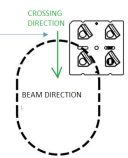
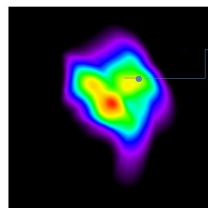

LED XP-G3
 FWHM Asymmetric
 Efficiency 94 %
 Peak intensity 0.890 cd/lm
 Required components:

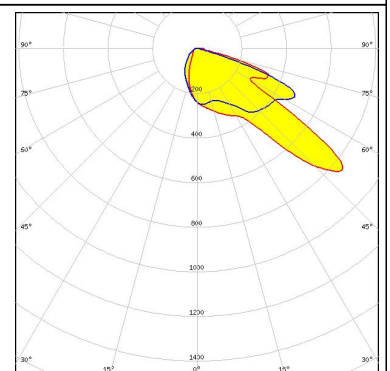

PHOTOMETRIC DATA (MEASURED):



LED XP-L
 FWHM Asymmetric
 Efficiency 94 %
 Peak intensity 0.800 cd/lm
 Required components:

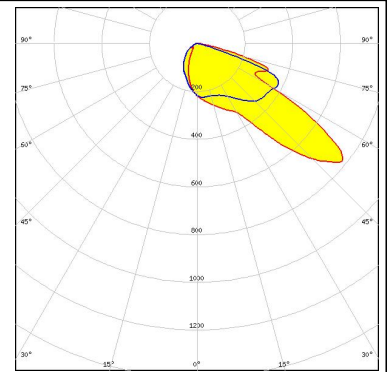
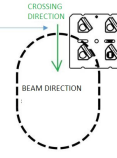
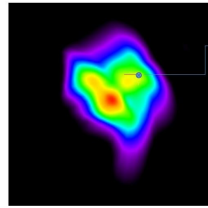

LED XP-L HI
 FWHM Asymmetric
 Efficiency 94 %
 Peak intensity 1.000 cd/lm
 Required components:

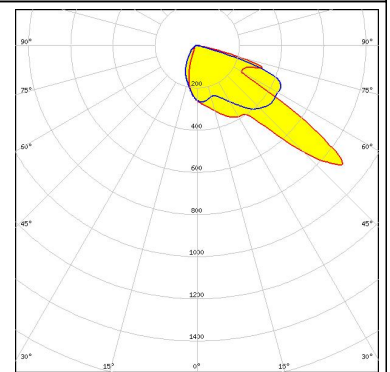

LED XP-L2
 FWHM Asymmetric
 Efficiency 94 %
 Peak intensity 0.720 cd/lm
 Required components:

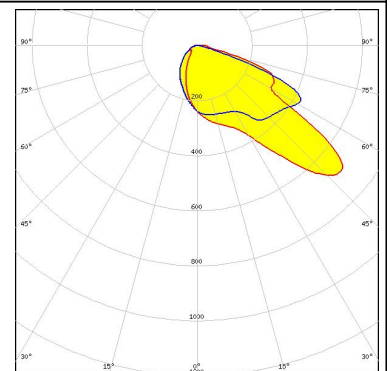

LED XT-E
 FWHM Asymmetric
 Efficiency 94 %
 Peak intensity 0.950 cd/lm
 Required components:

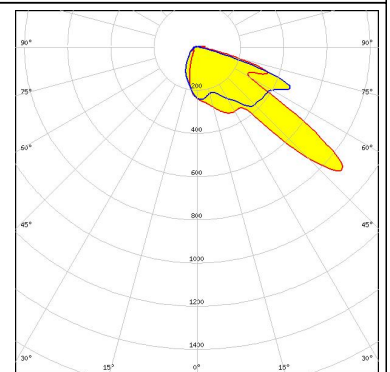
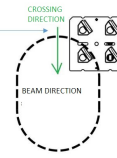
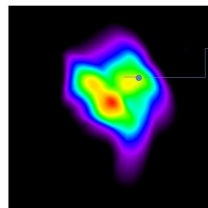

PHOTOMETRIC DATA (MEASURED):

LG Innotek

LED H35C0 (LEMWA33)
 FWHM Asymmetric
 Efficiency 94 %
 Peak intensity 0.900 cd/lm
 Required components:

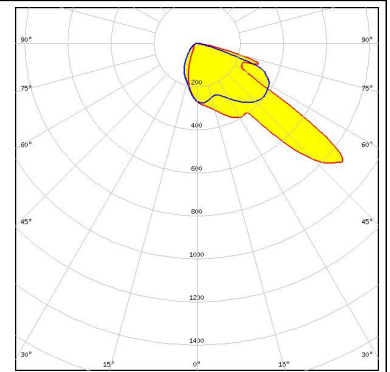
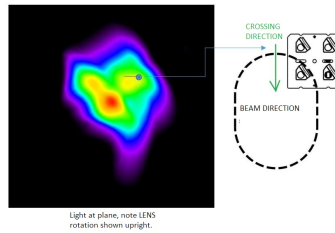

LG Innotek

LED H35C1 (LEMWA33)
 FWHM Asymmetric
 Efficiency 94 %
 Peak intensity 0.980 cd/lm
 Required components:

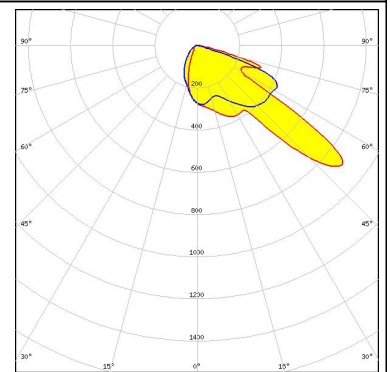
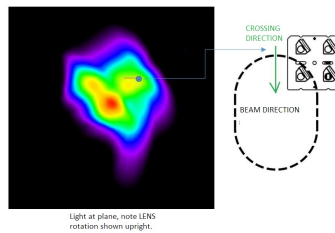

LUMILEDS

LED LUXEON 5050
 FWHM Asymmetric
 Efficiency 94 %
 Peak intensity 0.810 cd/lm
 Required components:

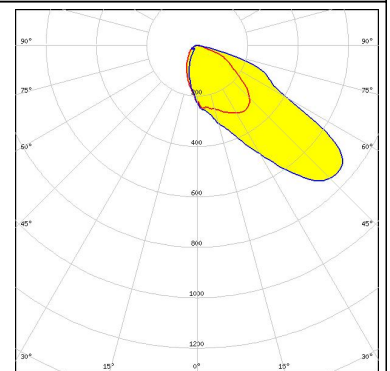

LUMILEDS

LED LUXEON MZ
 FWHM Asymmetric
 Efficiency 94 %
 Peak intensity 0.900 cd/lm
 Required components:

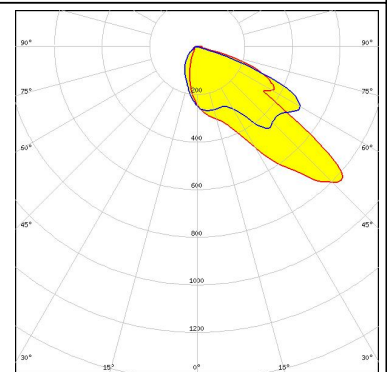

PHOTOMETRIC DATA (MEASURED):

LUMILEDS

LED LUXEON Q
 FWHM Asymmetric
 Efficiency 94 %
 Peak intensity 0.960 cd/lm
 Required components:

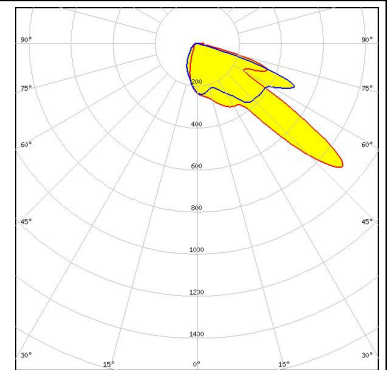
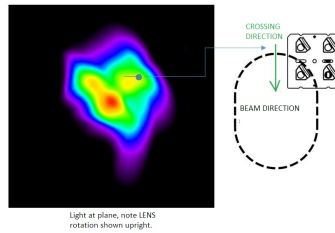

LUMILEDS

LED LUXEON R
 FWHM Asymmetric
 Efficiency 94 %
 Peak intensity 1.000 cd/lm
 Required components:

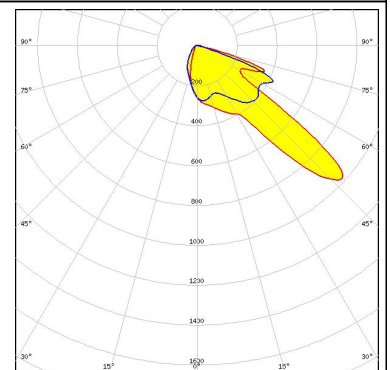
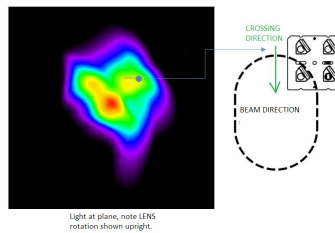

LUMILEDS

LED LUXEON Rebel ES
 FWHM Asymmetric
 Efficiency 94 %
 Peak intensity 1.050 cd/lm
 Required components:

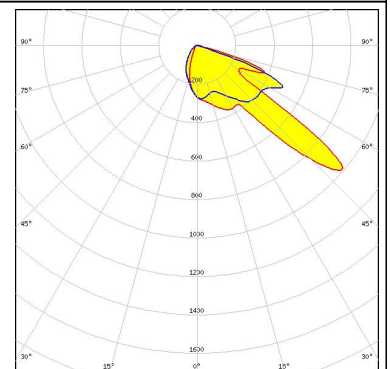
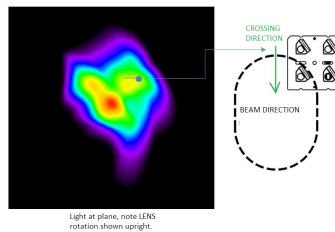

LUMILEDS

LED LUXEON T
 FWHM Asymmetric
 Efficiency 94 %
 Peak intensity 0.990 cd/lm
 Required components:

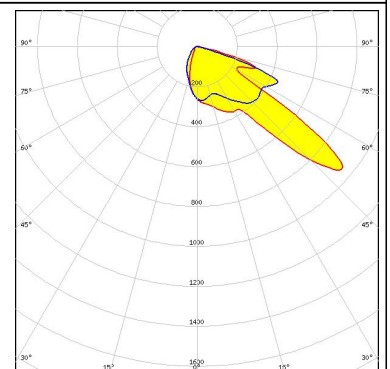
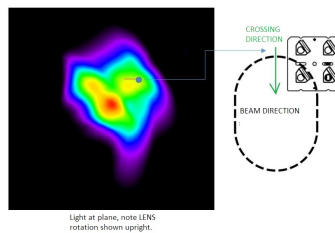

PHOTOMETRIC DATA (MEASURED):

LUMILEDS

LED LUXEON TX
 FWHM Asymmetric
 Efficiency 94 %
 Peak intensity 1.070 cd/lm
 Required components:

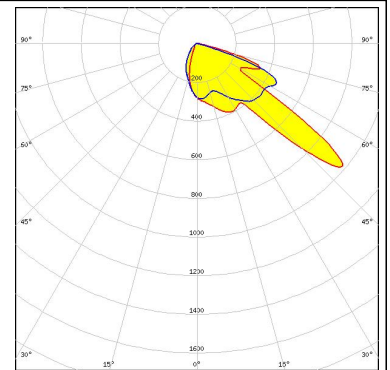
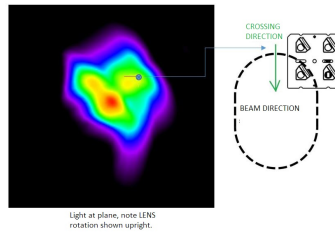

LUMILEDS

LED LUXEON V
 FWHM Asymmetric
 Efficiency 94 %
 Peak intensity 0.780 cd/lm
 Required components:

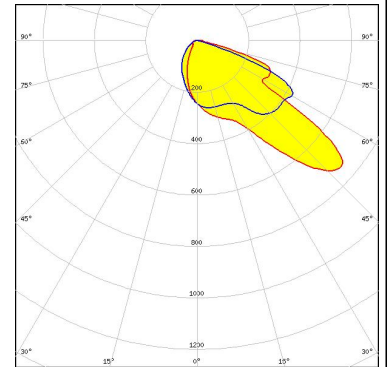
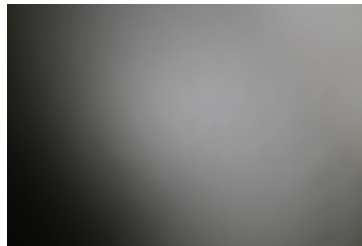

LUMILEDS

LED LUXEON Z ES
 FWHM Asymmetric
 Efficiency 94 %
 Peak intensity 1.400 cd/lm
 Required components:

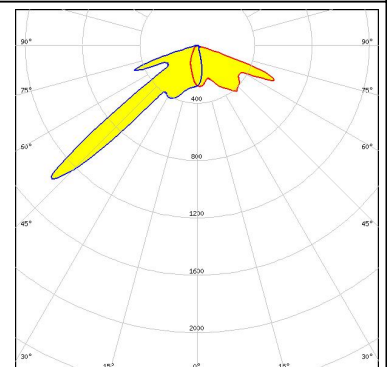
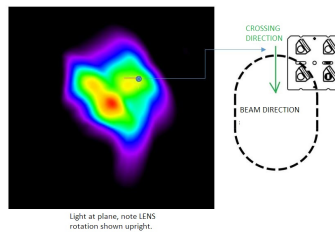

NICHIA

LED NCSxx19A
 FWHM Asymmetric
 Efficiency 94 %
 Peak intensity 1.160 cd/lm
 Required components:

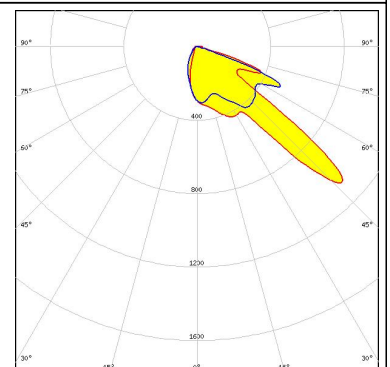
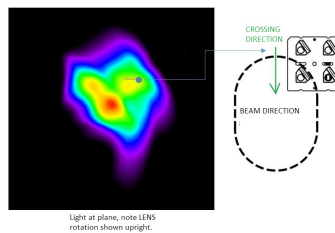

PHOTOMETRIC DATA (MEASURED):



LED NCSxx19B
 FWHM Asymmetric
 Efficiency 94 %
 Peak intensity 1.120 cd/lm
 Required components:

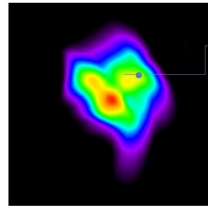

Light at plane, note LENS rotation shown upright.

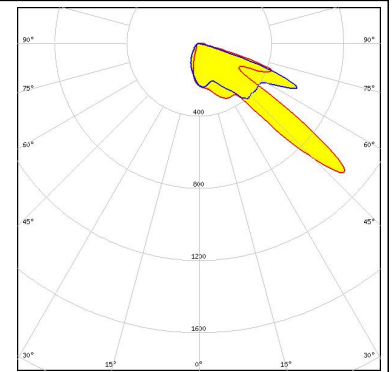

LED NS9x383
 FWHM Asymmetric
 Efficiency 94 %
 Peak intensity 0.750 cd/lm
 Required components:

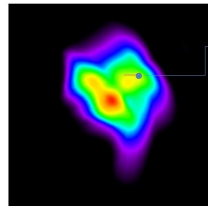

Light at plane, note LENS rotation shown upright.

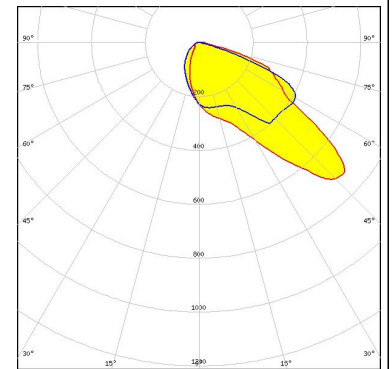

LED NVSW3x9A
 FWHM Asymmetric
 Efficiency 94 %
 Peak intensity 0.830 cd/lm
 Required components:

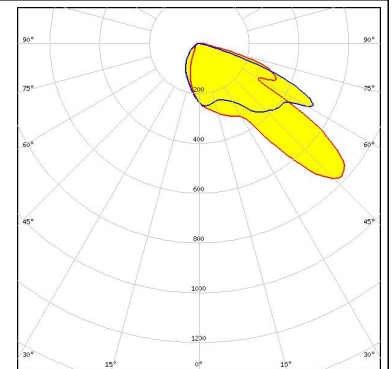

LED NVSxE21A
 FWHM Asymmetric
 Efficiency 94 %
 Peak intensity 1.400 cd/lm
 Required components:

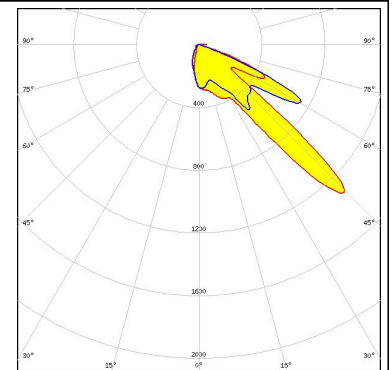

PHOTOMETRIC DATA (MEASURED):

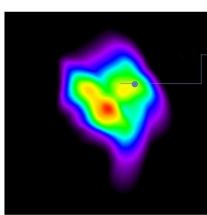
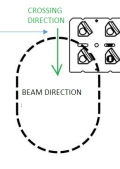
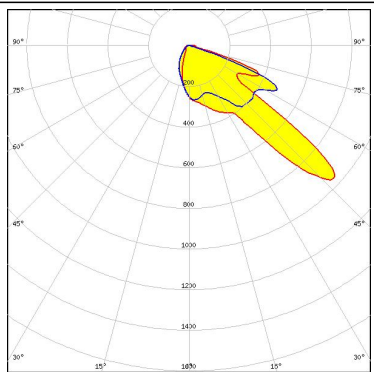
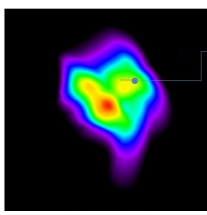
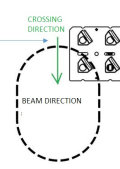
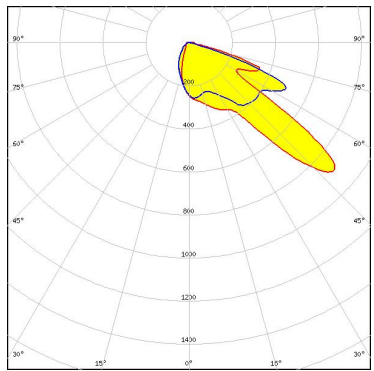
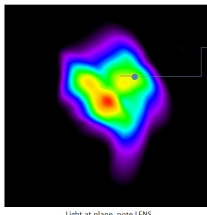
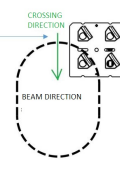
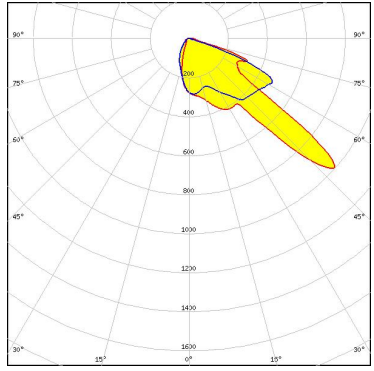
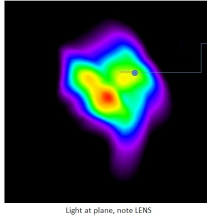
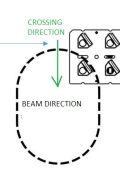
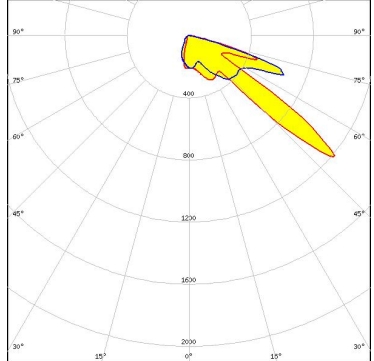
<p>NICHIA</p> <p>LED NVSxx19A</p> <p>FWHM Asymmetric</p> <p>Efficiency 94 %</p> <p>Peak intensity 1.020 cd/lm</p> <p>Required components:</p>	 <p>Light at plane, note LENS rotation shown upright.</p>		
<p>NICHIA</p> <p>LED NVSxx19B/NVSxx19C</p> <p>FWHM Asymmetric</p> <p>Efficiency 94 %</p> <p>Peak intensity 0.940 cd/lm</p> <p>Required components:</p>	 <p>Light at plane, note LENS rotation shown upright.</p>		
<p>OSRAM Opto Semiconductors</p> <p>LED Oslon Square PC</p> <p>FWHM Asymmetric</p> <p>Efficiency 94 %</p> <p>Peak intensity 1.100 cd/lm</p> <p>Required components:</p>	 <p>Light at plane, note LENS rotation shown upright.</p>		
<p>OSRAM Opto Semiconductors</p> <p>LED Oslon SSL 150</p> <p>FWHM Asymmetric</p> <p>Efficiency 94 %</p> <p>Peak intensity 1.300 cd/lm</p> <p>Required components:</p>	 <p>Light at plane, note LENS rotation shown upright.</p>		

PHOTOMETRIC DATA (MEASURED):

OSRAM

Opto Semiconductors

LED Oslon SSL 80
 FWHM Asymmetric
 Efficiency 94 %
 Peak intensity 1.300 cd/lm
 Required components:

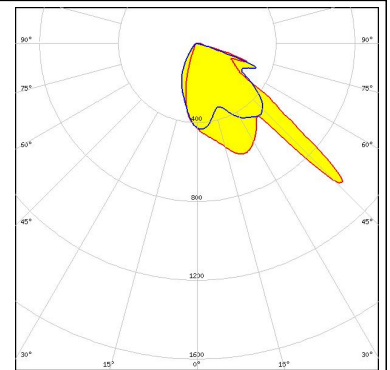

PHILIPS

LED Fortimo FastFlex LED board 2x8 DA G4
 FWHM Asymmetric
 Efficiency 94 %
 Peak intensity 1.100 cd/lm
 Required components:

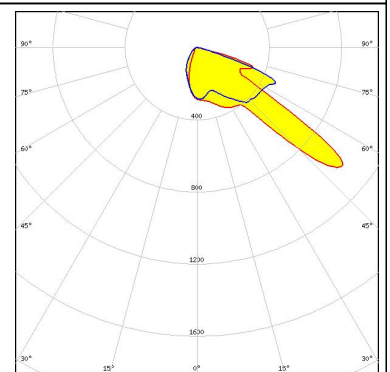

PHILIPS

LED Fortimo FastFlex LED board 2x8 DAX G4
 FWHM Asymmetric
 Efficiency 94 %
 Peak intensity 0.890 cd/lm
 Required components:

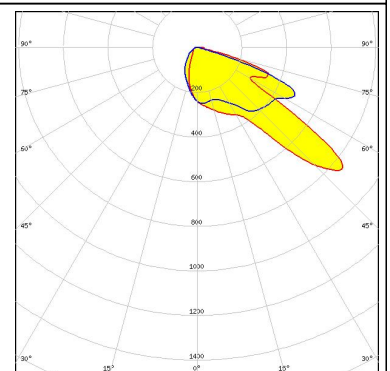

SAMSUNG

LED LH351A(3535)
 FWHM Asymmetric
 Efficiency 94 %
 Peak intensity 1.200 cd/lm
 Required components:

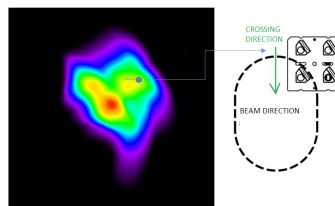

Light at plane, note LENS rotation shown upright.

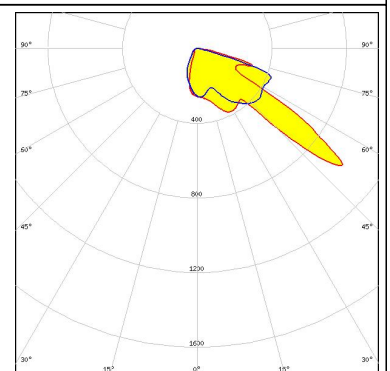

PHOTOMETRIC DATA (MEASURED):

SAMSUNG

LED LH351B
 FWHM Asymmetric
 Efficiency 94 %
 Peak intensity 0.880 cd/lm
 Required components:

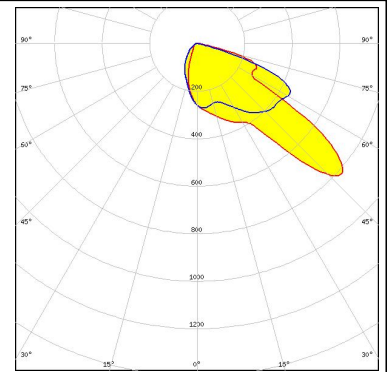

SAMSUNG

LED LH351Z
 FWHM Asymmetric
 Efficiency 94 %
 Peak intensity 1.000 cd/lm
 Required components:

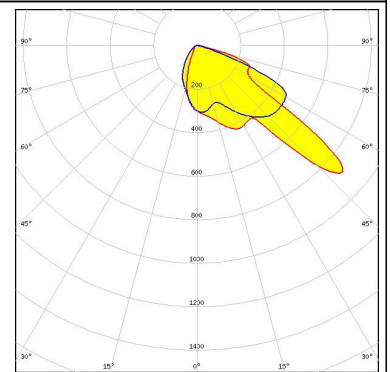
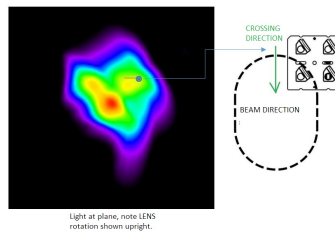



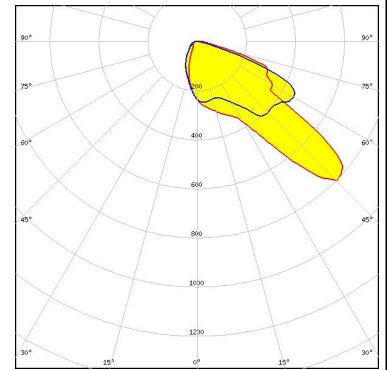
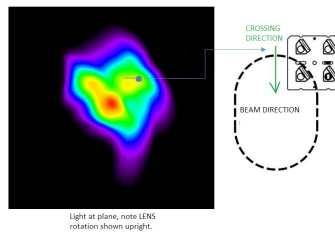

LED Acrich MJT 4040
 FWHM Asymmetric
 Efficiency 94 %
 Peak intensity 0.830 cd/lm
 Required components:

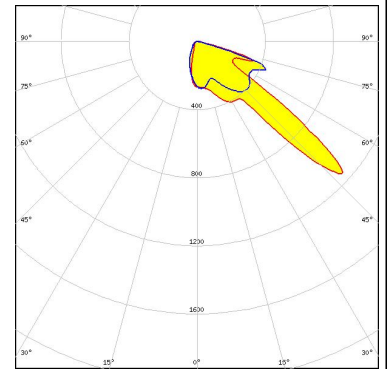
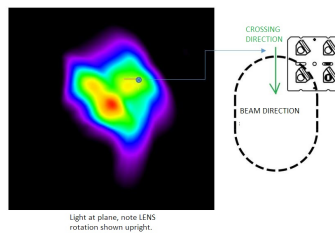

LED Z5
 FWHM Asymmetric
 Efficiency 94 %
 Peak intensity 1.300 cd/lm
 Required components:

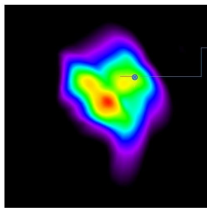
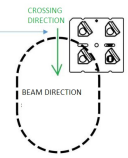
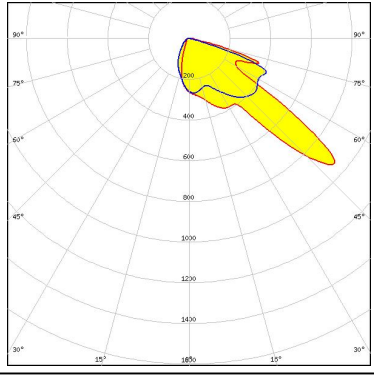

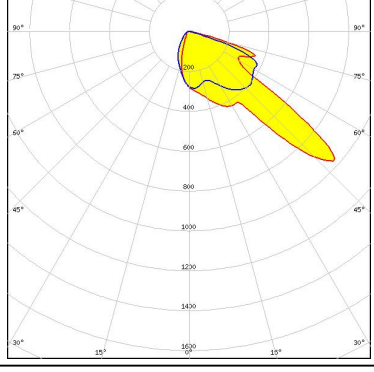
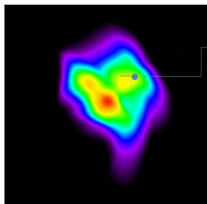
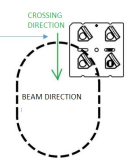
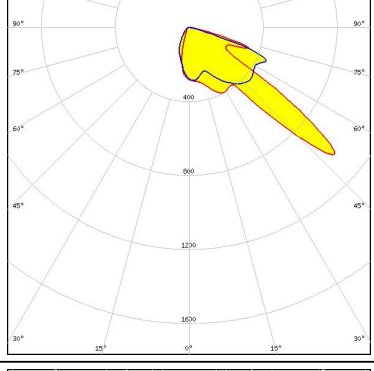
PHOTOMETRIC DATA (MEASURED):

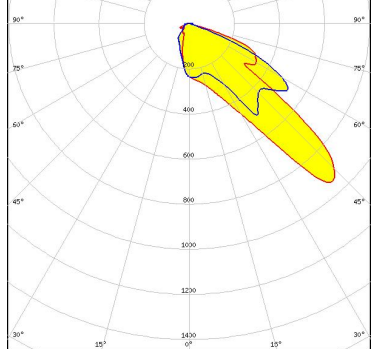
<p>SEOL SEOL SEMICONDUCTOR</p> <p>LED Z5M</p> <p>FWHM Asymmetric</p> <p>Efficiency 94 %</p> <p>Peak intensity 1.000 cd/lm</p> <p>Required components:</p>	 <p>Light at plane, note LENS rotation shown upright.</p> 	
<p>SEOL SEOL SEMICONDUCTOR</p> <p>LED Z5M1/Z5M2</p> <p>FWHM Asymmetric</p> <p>Efficiency 94 %</p> <p>Peak intensity 1.000 cd/lm</p> <p>Required components:</p>	 <p>Light at plane, note LENS rotation shown upright.</p> 	
<p>SEOL SEOL SEMICONDUCTOR</p> <p>LED Z5P</p> <p>FWHM Asymmetric</p> <p>Efficiency 94 %</p> <p>Peak intensity 1.130 cd/lm</p> <p>Required components:</p>	 <p>Light at plane, note LENS rotation shown upright.</p> 	
<p>SEOL SEOL SEMICONDUCTOR</p> <p>LED Z8Y22</p> <p>FWHM Asymmetric</p> <p>Efficiency 94 %</p> <p>Peak intensity 0.980 cd/lm</p> <p>Required components:</p>	 <p>Light at plane, note LENS rotation shown upright.</p> 	

PHOTOMETRIC DATA (MEASURED):

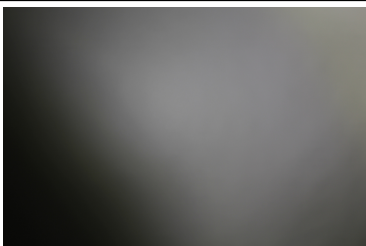
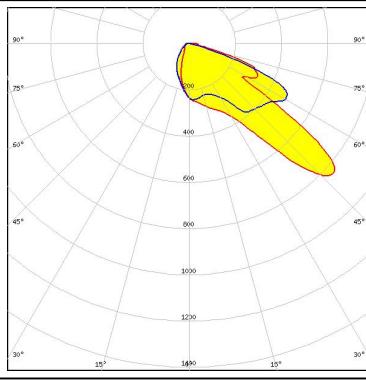
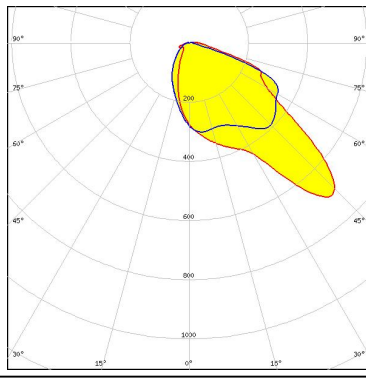
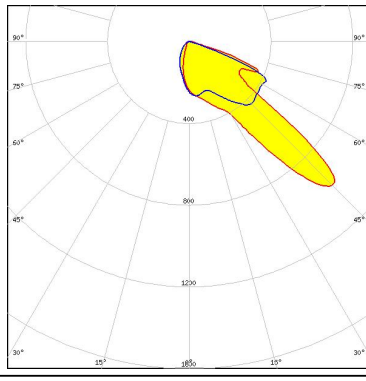
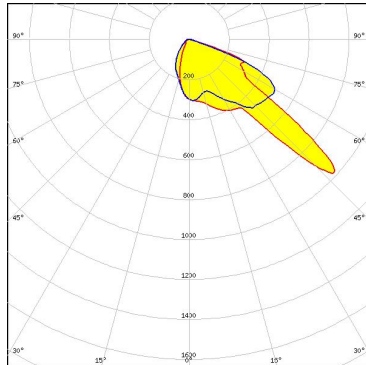
<p>SEMI SEOUL SEMICONDUCTOR</p> <p>LED Z8Y22P FWHM Asymmetric Efficiency 94 % Peak intensity 0.900 cd/lm Required components:</p>		
<p>TOSHIBA Leading Innovation >>></p> <p>LED TL1L3 FWHM Asymmetric Efficiency 94 % Peak intensity 0.760 cd/lm Required components:</p>		
<p>TOSHIBA Leading Innovation >>></p> <p>LED TL1L4 FWHM Asymmetric Efficiency 91 % Peak intensity 1.000 cd/lm Required components:</p>		
<p>TRIDONIC</p> <p>LED RLE G1 49x121mm 2000lm xxx EXC OTD FWHM Asymmetric Efficiency 94 % Peak intensity 1.100 cd/lm Required components:</p>		

PHOTOMETRIC DATA (MEASURED):

TRIDONIC

LED RLE G1 49x133mm 2000lm xxx EXC OTD
FWHM Asymmetric
Efficiency 94 %
Peak intensity 1.100 cd/lm
Required components:

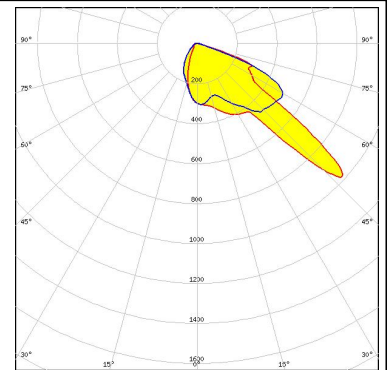

TRIDONIC

LED RLE G1 49x223mm 4000lm xxx EXC OTD
FWHM Asymmetric
Efficiency 94 %
Peak intensity 1.100 cd/lm
Required components:

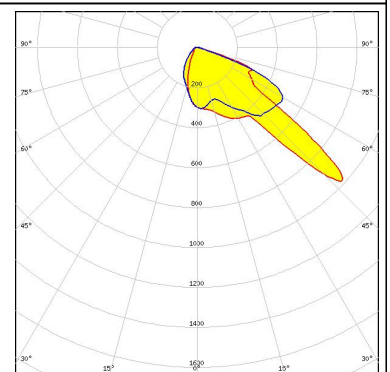

TRIDONIC

LED RLE G1 49x245mm 4000lm xxx EXC OTD
FWHM Asymmetric
Efficiency 94 %
Peak intensity 1.100 cd/lm
Required components:

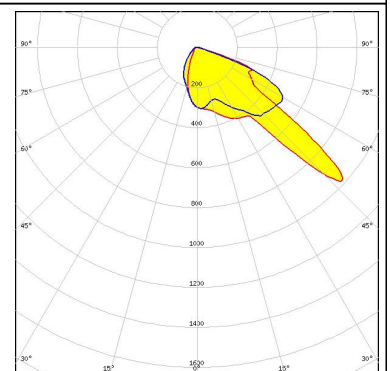

TRIDONIC

LED RLE G2 HP 2x8 4000lm
FWHM Asymmetric
Efficiency 94 %
Peak intensity 1.200 cd/lm
Required components:

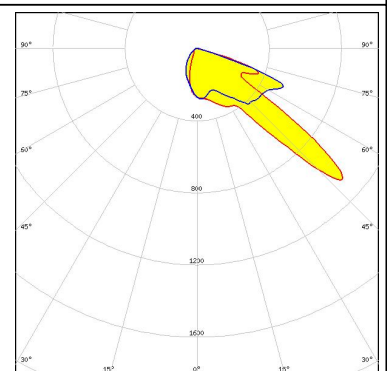

PHOTOMETRIC DATA (SIMULATED):

OSRAM

LED PrevaLED Brick DC 2x8
 FWHM Asymmetric
 Efficiency 92 %
 Peak intensity 1.100 cd/lm
 Required components:

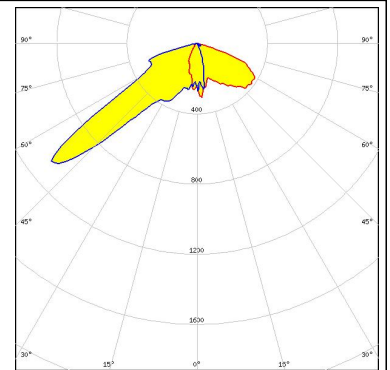

OSRAM
Opto Semiconductors

LED Duris S8
 FWHM Asymmetric
 Efficiency 94 %
 Peak intensity 0.850 cd/lm
 Required components:

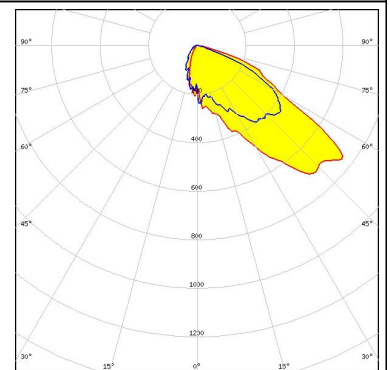

OSRAM
Opto Semiconductors

LED OSCONIQ P 3737 (3W version)
 FWHM Asymmetric
 Efficiency 94 %
 Peak intensity 3.670 cd/lm
 Required components:

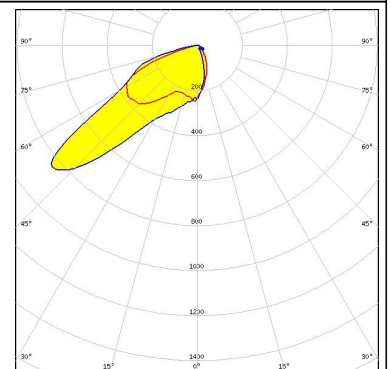

OSRAM
Opto Semiconductors

LED Oslon Square Gen3
 FWHM Asymmetric
 Efficiency 92 %
 Peak intensity 1.100 cd/lm
 Required components:

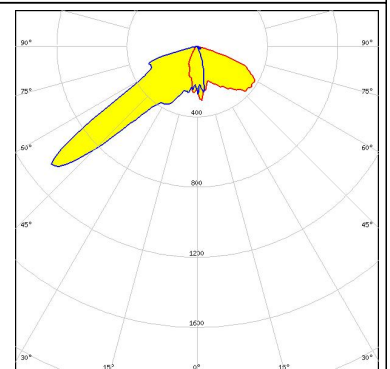

PHOTOMETRIC DATA (SIMULATED):

SAMSUNG

LED LH351D
FWHM Asymmetric
Efficiency 92 %
Peak intensity 0.810 cd/lm
Required components:

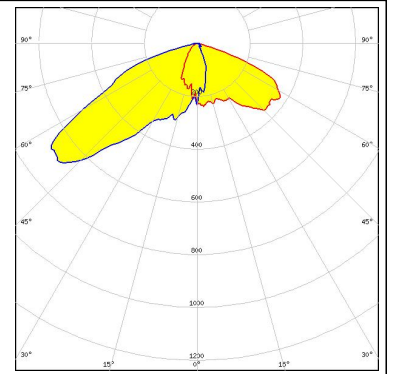

GENERAL INFORMATION:

NOTE: The typical beam angle will be changed by different color, chip size and chip position tolerance. The typical total beam angle is the full angle measured where the luminous intensity is half of the peak value.

MATERIALS:

As part of our continuous research and improvement processes, and to ensure the best possible quality and availability of our products, LEDiL reserves the right to change material grades without notice.

PRODUCT DATA USER AGREEMENT AND DISCLAIMER:

The measured data in the provided downloadable LEDiL Product Datasheets and Mechanical 2D-Drawings is rounded and provided as reference for planning. LEDiL Oy's optical specifications have been verified by conducting performance testing of the products in accordance with the company's quality system. The reported data are averaged results of multiple measurements with typical variation. LEDiL Oy reserves the right to without prior notification make changes and improvements to its products.

LEDiL Oy assumes neither warranty, nor guarantee nor any other liability of any kind for the contents and correctness of the provided data. The provided data has been generated with highest diligence but the provided data may in reality not represent the complete possible variation range of all intrinsic parameters. Therefore, in certain cases a deviation from the provided data could occur.

LEDiL Oy reserves the right to undertake technical changes of its products without further notification which could lead to changes in the provided data. LEDiL Oy assumes no liability of any kind for the possible deviation from any provided data or any other damage resulting from the usage of the provided data.

The user agrees to this disclaimer and user agreement with the download or usage of the provided files.

LEDiL Oy

Joensuunkatu 13
FI-24240 SALO
Finland

LEDiL Inc.

228 West Page Street
Suite D
Sycamore IL 60178
USA

Local sales and technical support

[www.ledil.com/
where_to_buy](http://www.ledil.com/where_to_buy)

Shipping locations

Salo, Finland
Hong Kong, China

Distribution Partners

[www.ledil.com/
where_to_buy](http://www.ledil.com/where_to_buy)