



Chipsmall Limited consists of a professional team with an average of over 10 year of expertise in the distribution of electronic components. Based in Hongkong, we have already established firm and mutual-benefit business relationships with customers from,Europe,America and south Asia,supplying obsolete and hard-to-find components to meet their specific needs.

With the principle of “Quality Parts,Customers Priority,Honest Operation,and Considerate Service”,our business mainly focus on the distribution of electronic components. Line cards we deal with include Microchip,ALPS,ROHM,Xilinx,Pulse,ON,Everlight and Freescale. Main products comprise IC,Modules,Potentiometer,IC Socket,Relay,Connector.Our parts cover such applications as commercial,industrial, and automotives areas.

We are looking forward to setting up business relationship with you and hope to provide you with the best service and solution. Let us make a better world for our industry!



Contact us

Tel: +86-755-8981 8866 Fax: +86-755-8427 6832

Email & Skype: info@chipsmall.com Web: www.chipsmall.com

Address: A1208, Overseas Decoration Building, #122 Zhenhua RD., Futian, Shenzhen, China



STRADA-2X2-ME-WIDE1

Beam with excellent longitudinal luminance uniformity fulfilling EN13201 M-class requirements where road width is equal to or less than the pole height. Added house-side backlight.

TECHNICAL SPECIFICATIONS:

Dimensions	50.0 mm
Height	8.3 mm
Fastening	glue, screw, pin
Colour	clear
Box size	480 x 280 x 300 mm
Box weight	7.9 kg
Quantity in Box	800 pcs
ROHS compliant	yes ⓘ



MATERIAL SPECIFICATIONS:

Component	Type	Material	Colour
STRADA-2X2-ME-WIDE1	Lens array	PMMA	clear

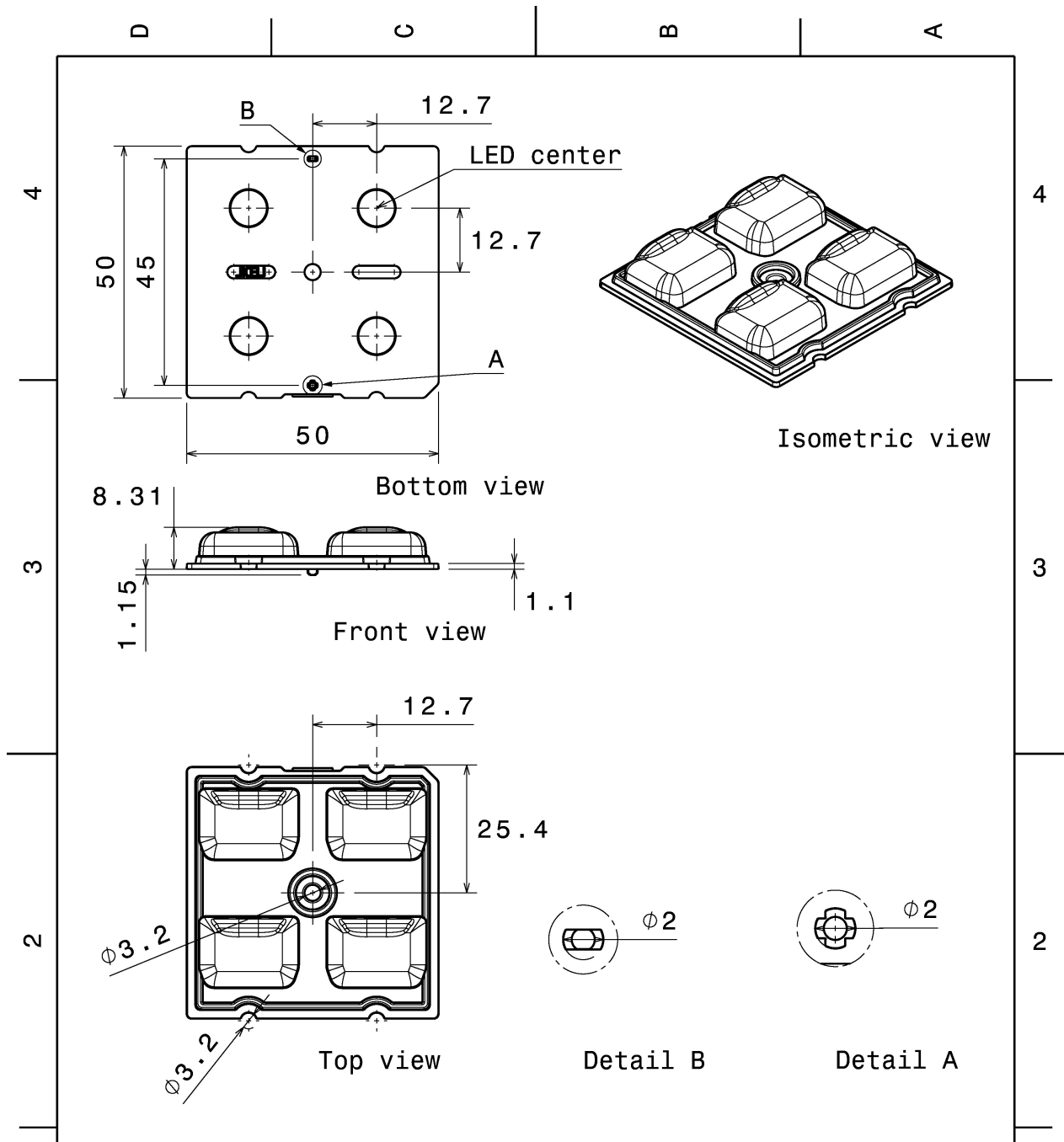

<p>Tolerances if not otherwise shown According to DIN ISO 2768-1 Linear measures: Up to 30mm class M, otherwise class C. According to DIN ISO 2768-2 Form and position: class L</p>		<p>LEDiL Ledil Oy Salorankatu 10 FIN 24240 SALO Finland</p>	
<p>THIRD ANGLE PROJECTION: </p>		<p>DRAWING TITLE STRADA-2X2-ME-WIDE1</p>	
<p>This drawing is the property of LEDiL Oy. It may not be reproduced, copied or communicated without a written agreement with LEDiL Oy.</p>		<p>SIZE PART NUMBER A4 C14164</p>	
<p>SCALE 1:1</p>		<p>WEIGHT - SHEET 1/1</p>	

PHOTOMETRIC DATA (MEASURED):



LED XD16
 FWHM Asymmetric
 Efficiency 94 %
 Peak intensity 1.400 cd/lm
 Required components:

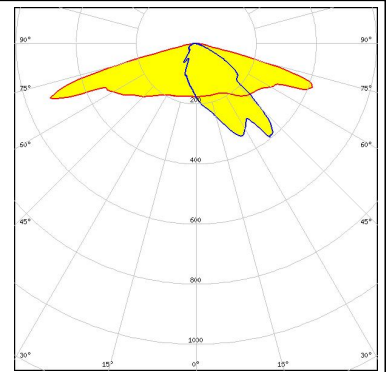

LED XD16 2x2 cluster
 FWHM Asymmetric
 Efficiency 94 %
 Peak intensity 0.700 cd/lm
 Required components:

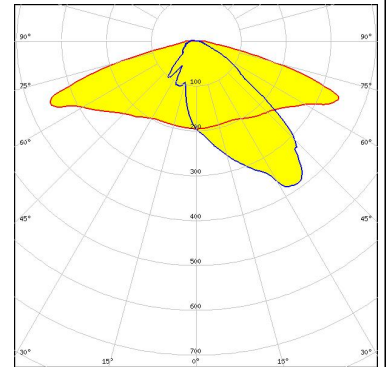
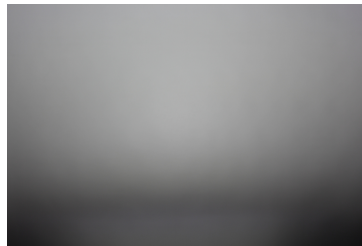

LED XP-G
 FWHM Asymmetric
 Efficiency 86 %
 Peak intensity 0.950 cd/lm
 Required components:
 Undefined Manufacturer: Protective Plate, Glass

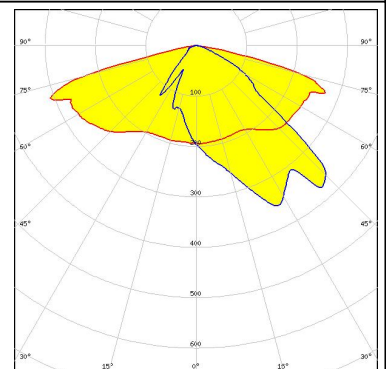

LED XP-G2
 FWHM Asymmetric
 Efficiency 83 %
 Peak intensity 0.860 cd/lm
 Required components:
 Undefined Manufacturer: Protective Plate, Glass

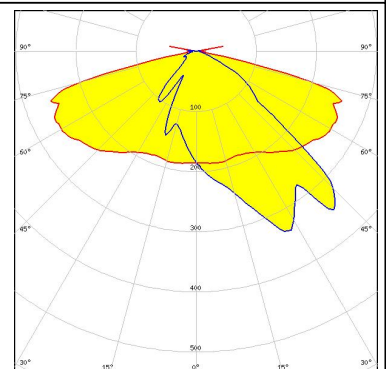

PHOTOMETRIC DATA (MEASURED):



LED XP-G3
FWHM Asymmetric
Efficiency 94 %
Peak intensity 1.000 cd/lm
Required components:

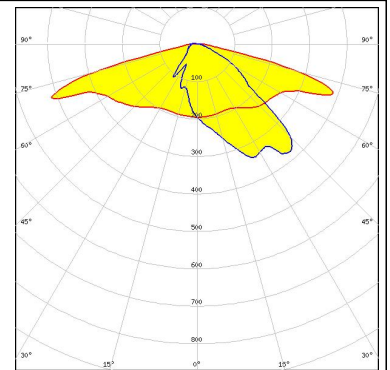

LED XP-L
FWHM Asymmetric
Efficiency 83 %
Peak intensity 0.660 cd/lm
Required components:
Undefined Manufacturer: Protective Plate, Glass



LED XP-L2
FWHM Asymmetric
Efficiency 85 %
Peak intensity 0.600 cd/lm
Required components:

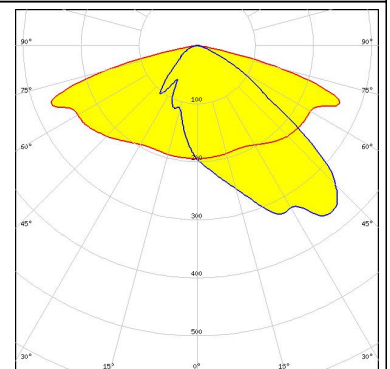

LED H35C1 (LEMWA33)
FWHM Asymmetric
Efficiency 86 %
Peak intensity 0.820 cd/lm
Required components:

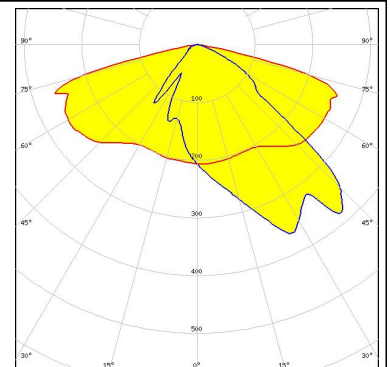

PHOTOMETRIC DATA (MEASURED):

LUMILEDS

LED LUXEON TX

FWHM Asymmetric

Efficiency 84 %

Peak intensity 0.880 cd/lm

Required components:

Undefined Manufacturer: Protective Plate, Glass

LUMILEDS

LED LUXEON V

FWHM Asymmetric

Efficiency 94 %

Peak intensity 0.770 cd/lm

Required components:

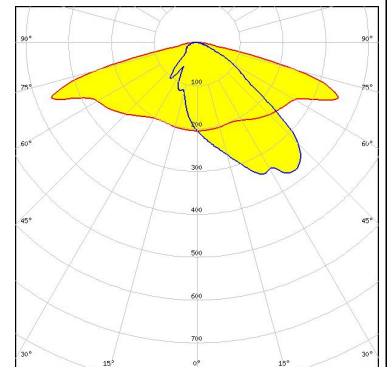

NICHIA

LED NVSW3x9A

FWHM Asymmetric

Efficiency 86 %

Peak intensity 0.780 cd/lm

Required components:

Undefined Manufacturer: Protective Plate, Glass

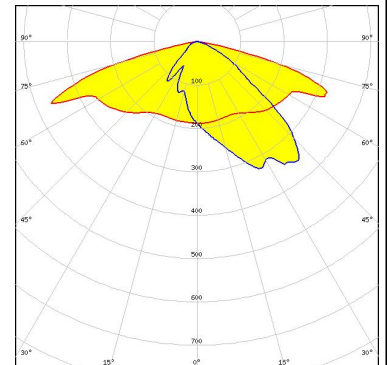
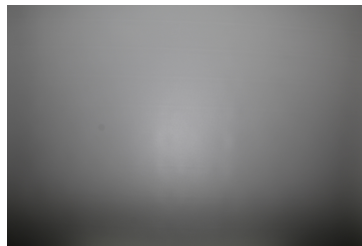

OSRAM

LED PrevaLED Brick DC 2x8

FWHM Asymmetric

Efficiency 86 %

Peak intensity 0.970 cd/lm

Required components:

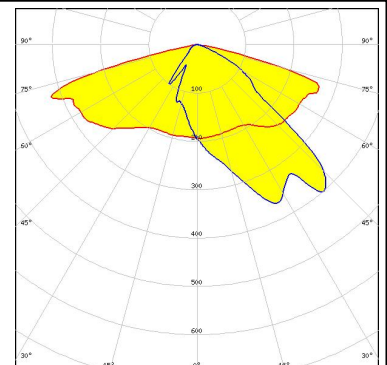

PHOTOMETRIC DATA (MEASURED):

OSRAM
Opto Semiconductors

LED Duris S8
FWHM Asymmetric
Efficiency 94 %
Peak intensity 0.620 cd/lm
Required components:

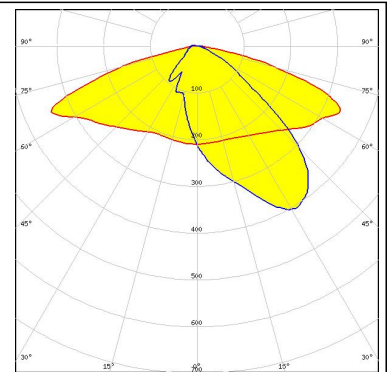

OSRAM
Opto Semiconductors

LED Oslon Square Gen3
FWHM Asymmetric
Efficiency 86 %
Peak intensity 0.970 cd/lm
Required components:

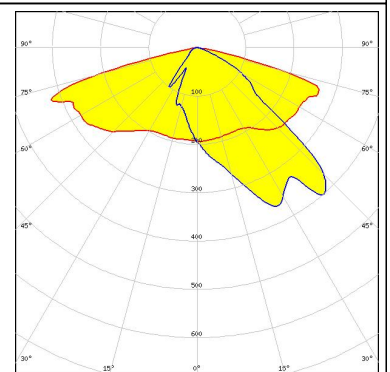
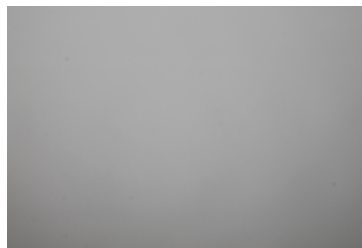

OSRAM
Opto Semiconductors

LED Oslon Square PC
FWHM Asymmetric
Efficiency 84 %
Peak intensity 0.900 cd/lm
Required components:

PHILIPS

LED Fortimo FastFlex LED board 2x8 DA G4
FWHM Asymmetric
Efficiency 86 %
Peak intensity 0.820 cd/lm
Required components:

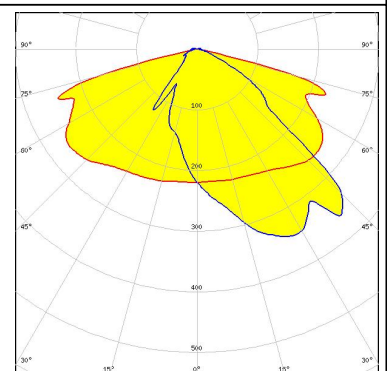

PHOTOMETRIC DATA (MEASURED):

PHILIPS

LED Fortimo FastFlex LED board 2x8 DAX G4
FWHM Asymmetric
Efficiency 94 %
Peak intensity 1.000 cd/lm
Required components:

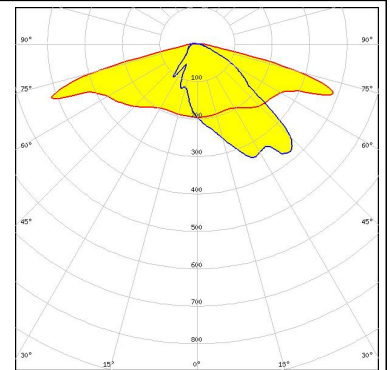

SAMSUNG

LED LH351B
FWHM Asymmetric
Efficiency 87 %
Peak intensity 0.740 cd/lm
Required components:
Undefined Manufacturer: Protective Plate, Glass

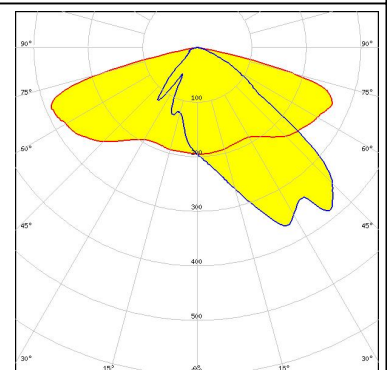

SAMSUNG

LED LH351B
FWHM Asymmetric
Efficiency 94 %
Peak intensity 0.920 cd/lm
Required components:

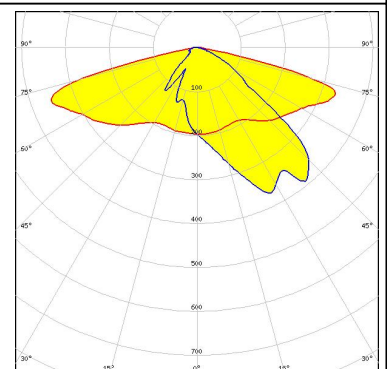

SEOUL SEMICONDUCTOR

LED Z8Y22
FWHM Asymmetric
Efficiency 94 %
Peak intensity 1.100 cd/lm
Required components:

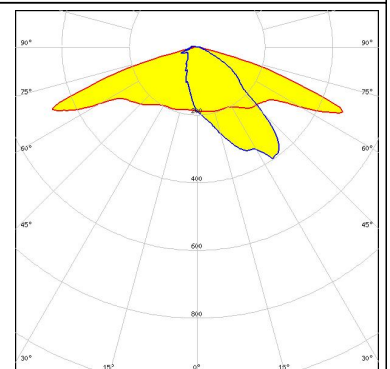

PHOTOMETRIC DATA (MEASURED):

TOSHIBA Leading Innovation >>>

LED TL1L4
FWHM Asymmetric
Efficiency 83 %
Peak intensity 0.880 cd/lm
Required components:

Undefined Manufacturer: Protective Plate, Glass

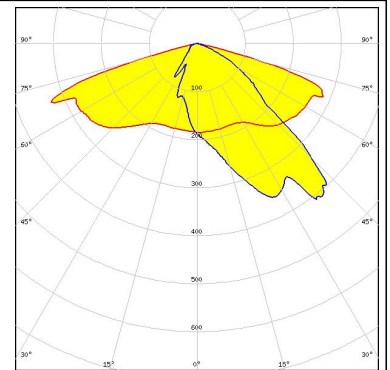

TRIDONIC

LED RLE G1 49x121mm 2000lm xxx EXC OTD
FWHM Asymmetric
Efficiency 94 %
Peak intensity 1.200 cd/lm
Required components:

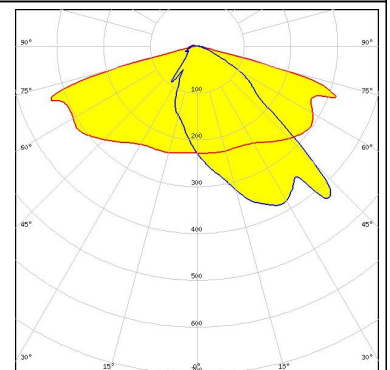

TRIDONIC

LED RLE G1 49x133mm 2000lm xxx EXC OTD
FWHM Asymmetric
Efficiency 94 %
Peak intensity 1.200 cd/lm
Required components:

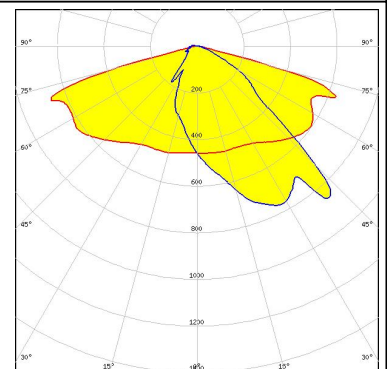

TRIDONIC

LED RLE G1 49x223mm 4000lm xxx EXC OTD
FWHM Asymmetric
Efficiency 94 %
Peak intensity 1.200 cd/lm
Required components:

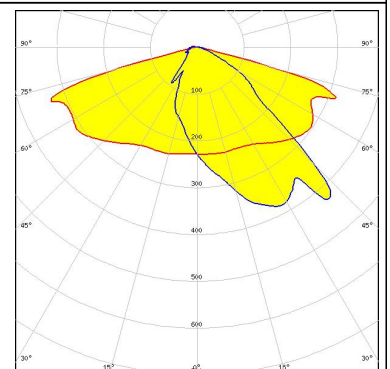

PHOTOMETRIC DATA (MEASURED):

TRIDONIC

LED RLE G1 49x245mm 4000lm xxx EXC OTD
FWHM Asymmetric
Efficiency 94 %
Peak intensity 1.200 cd/lm
Required components:

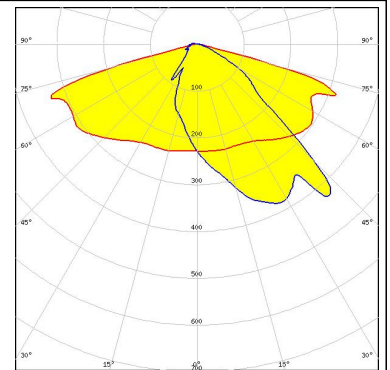

TRIDONIC

LED RLE G2 HP 2x8 4000lm
FWHM Asymmetric
Efficiency 94 %
Peak intensity 1.300 cd/lm
Required components:

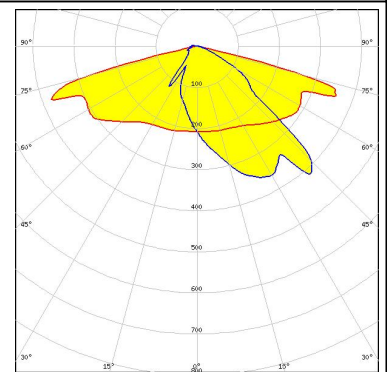

PHOTOMETRIC DATA (SIMULATED):



LED XHP35 HD
 FWHM Asymmetric
 Efficiency 94 %
 Peak intensity 0.550 cd/lm
 Required components:

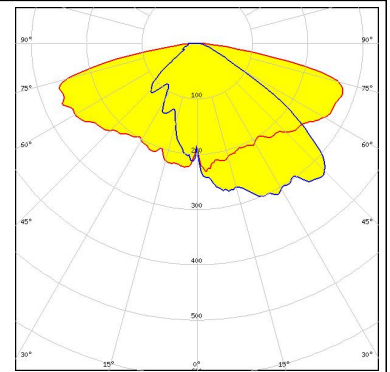

LED XHP35 HI
 FWHM Asymmetric
 Efficiency 94 %
 Peak intensity 0.760 cd/lm
 Required components:

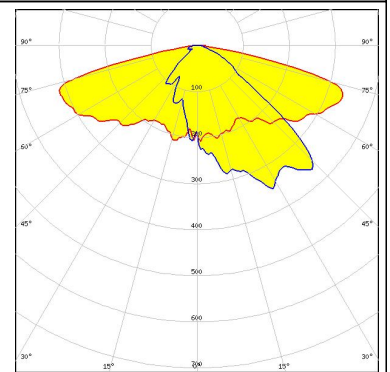

LED XP-L HI
 FWHM Asymmetric
 Efficiency 94 %
 Peak intensity 0.820 cd/lm
 Required components:

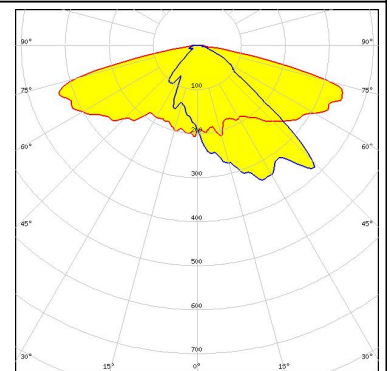

LED XT-E
 FWHM Asymmetric
 Efficiency 84 %
 Peak intensity cd/lm
 Required components:

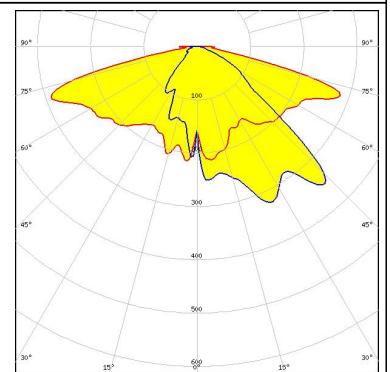

Undefined Manufacturer: Protective Plate, Glass

PHOTOMETRIC DATA (SIMULATED):

LUMILEDS

LED LUXEON 5050
 FWHM Asymmetric
 Efficiency 86 %
 Peak intensity 0.520 cd/lm

Required components:

Undefined Manufacturer: Protective Plate, Glass

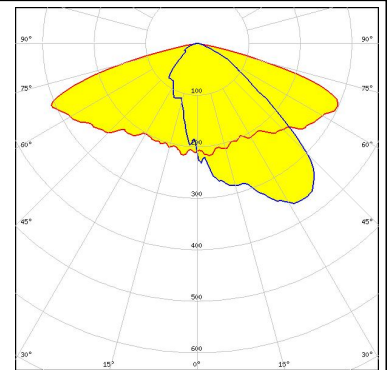

LUMILEDS

LED LUXEON 5050
 FWHM Asymmetric
 Efficiency 94 %
 Peak intensity 0.650 cd/lm

Required components:

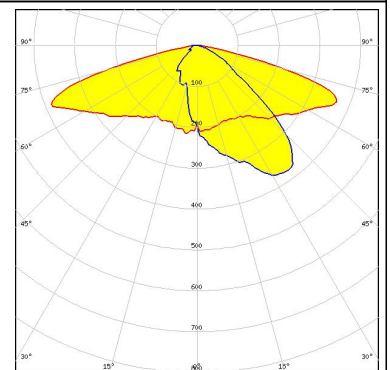

LUMILEDS

LED LUXEON T
 FWHM Asymmetric
 Efficiency 84 %
 Peak intensity cd/lm

Required components:

Undefined Manufacturer: Protective Plate, Glass

NICHIA

LED NVSW3x9A
 FWHM Asymmetric
 Efficiency 93 %
 Peak intensity 0.850 cd/lm

Required components:

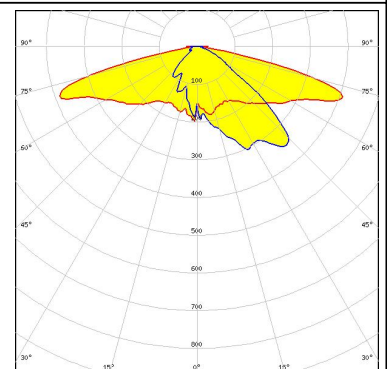

PHOTOMETRIC DATA (SIMULATED):



LED NVSxx19B/NVSxx19C
FWHM Asymmetric
Efficiency 94 %
Peak intensity 0.860 cd/lm
Required components:

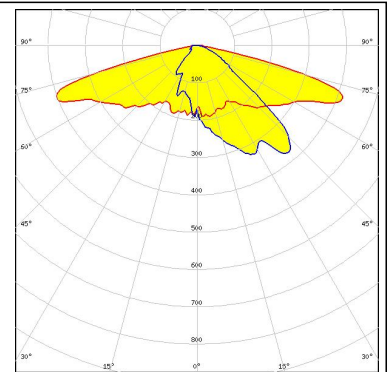

LED OSCONIQ P 3737 (2W version)
FWHM Asymmetric
Efficiency 94 %
Peak intensity 0.900 cd/lm
Required components:

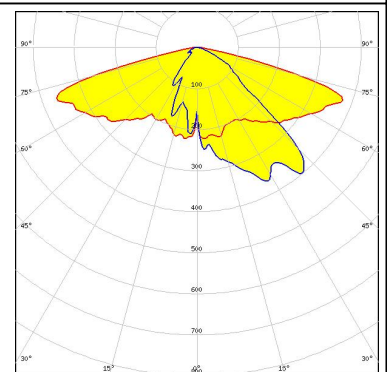

LED OSCONIQ P 3737 (3W version)
FWHM Asymmetric
Efficiency 94 %
Peak intensity 0.720 cd/lm
Required components:

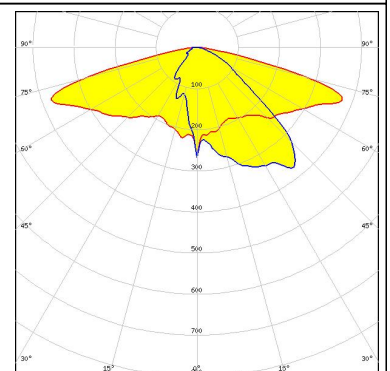

LED LH351D
FWHM Asymmetric
Efficiency 76 %
Peak intensity 0.440 cd/lm
Required components:

Undefined Manufacturer: Protective Plate, Glass

GENERAL INFORMATION:

NOTE: The typical beam angle will be changed by different color, chip size and chip position tolerance. The typical total beam angle is the full angle measured where the luminous intensity is half of the peak value.

MATERIALS:

As part of our continuous research and improvement processes, and to ensure the best possible quality and availability of our products, LEDiL reserves the right to change material grades without notice.

PRODUCT DATA USER AGREEMENT AND DISCLAIMER:

The measured data in the provided downloadable LEDiL Product Datasheets and Mechanical 2D-Drawings is rounded and provided as reference for planning. LEDiL Oy's optical specifications have been verified by conducting performance testing of the products in accordance with the company's quality system. The reported data are averaged results of multiple measurements with typical variation. LEDiL Oy reserves the right to without prior notification make changes and improvements to its products.

LEDiL Oy assumes neither warranty, nor guarantee nor any other liability of any kind for the contents and correctness of the provided data. The provided data has been generated with highest diligence but the provided data may in reality not represent the complete possible variation range of all intrinsic parameters. Therefore, in certain cases a deviation from the provided data could occur.

LEDiL Oy reserves the right to undertake technical changes of its products without further notification which could lead to changes in the provided data. LEDiL Oy assumes no liability of any kind for the possible deviation from any provided data or any other damage resulting from the usage of the provided data.

The user agrees to this disclaimer and user agreement with the download or usage of the provided files.

LEDiL Oy

Joensuunkatu 13
FI-24240 SALO
Finland

LEDiL Inc.

228 West Page Street
Suite D
Sycamore IL 60178
USA

Local sales and technical support

[www.ledil.com/
where_to_buy](http://www.ledil.com/where_to_buy)

Shipping locations

Salo, Finland
Hong Kong, China

Distribution Partners

[www.ledil.com/
where_to_buy](http://www.ledil.com/where_to_buy)