



Chipsmall Limited consists of a professional team with an average of over 10 year of expertise in the distribution of electronic components. Based in Hongkong, we have already established firm and mutual-benefit business relationships with customers from,Europe,America and south Asia,supplying obsolete and hard-to-find components to meet their specific needs.

With the principle of “Quality Parts,Customers Priority,Honest Operation,and Considerate Service”,our business mainly focus on the distribution of electronic components. Line cards we deal with include Microchip,ALPS,ROHM,Xilinx,Pulse,ON,Everlight and Freescale. Main products comprise IC,Modules,Potentiometer,IC Socket,Relay,Connector.Our parts cover such applications as commercial,industrial, and automotives areas.

We are looking forward to setting up business relationship with you and hope to provide you with the best service and solution. Let us make a better world for our industry!



Contact us

Tel: +86-755-8981 8866 Fax: +86-755-8427 6832

Email & Skype: info@chipsmall.com Web: www.chipsmall.com

Address: A1208, Overseas Decoration Building, #122 Zhenhua RD., Futian, Shenzhen, China



ANGELETTE-WAS

Asymmetric wall-washer beam

TECHNICAL SPECIFICATIONS:

Dimensions	Ø 97.2 x 83.4 mm
Height	84.1 mm
Fastening	socket
Colour	metal
Box size	480 x 280 x 300 mm
Box weight	5.4 kg
Quantity in Box	90 pcs
ROHS compliant	yes ⓘ





MATERIAL SPECIFICATIONS:

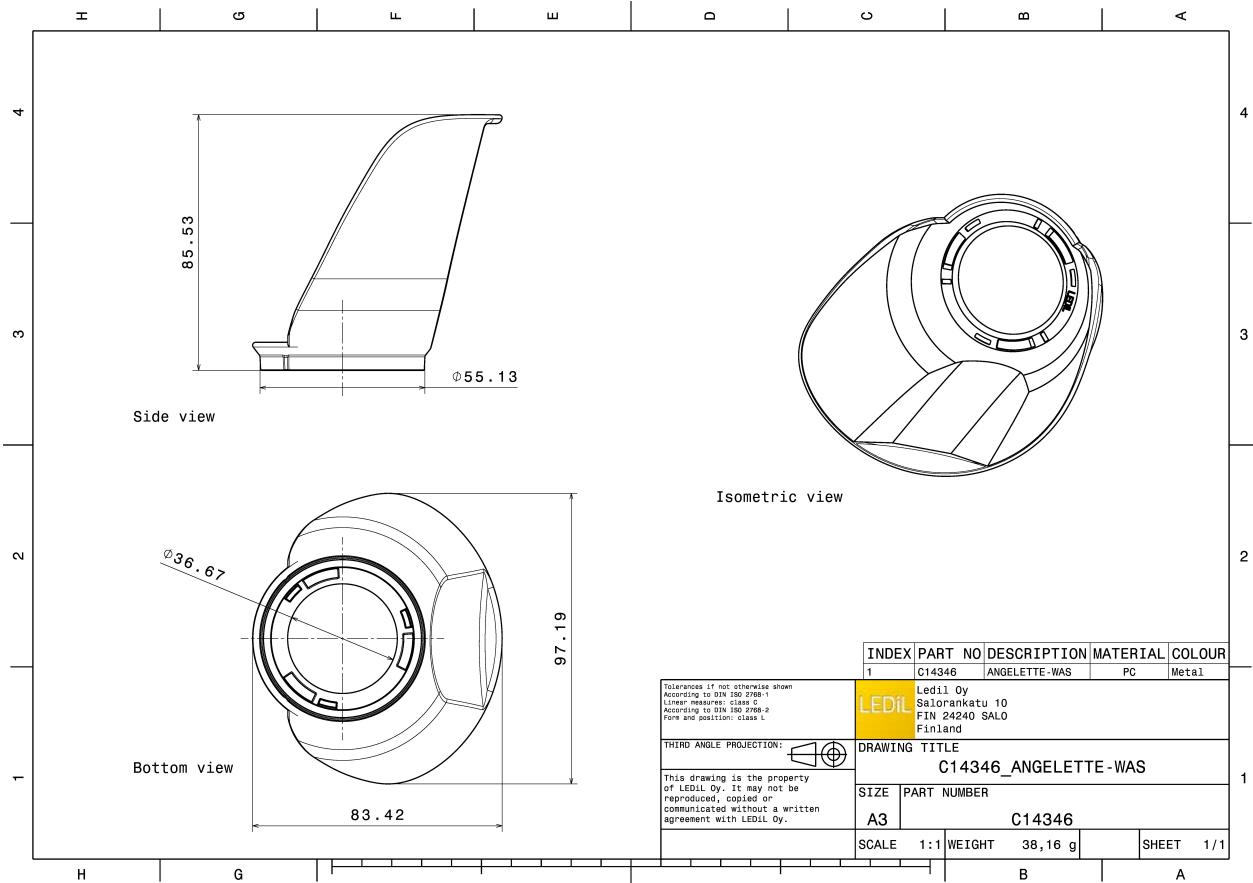

Component	Type	Material	Colour	Coating
ANGELETTE-WAS	Reflector	PC	metal	lacquer

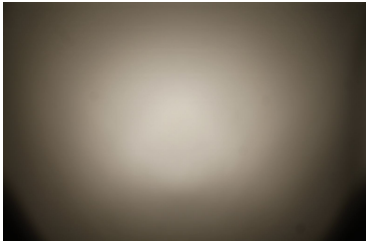
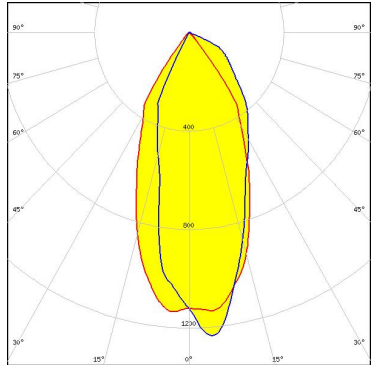

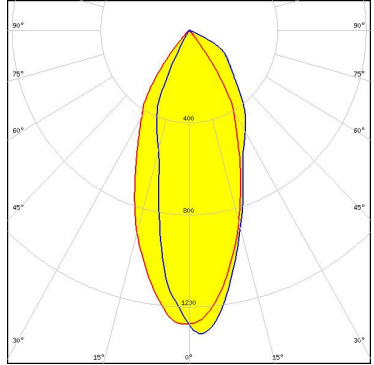
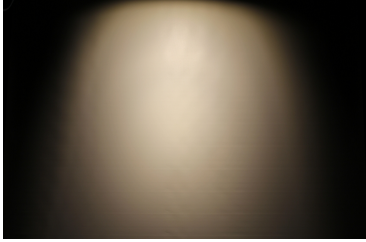
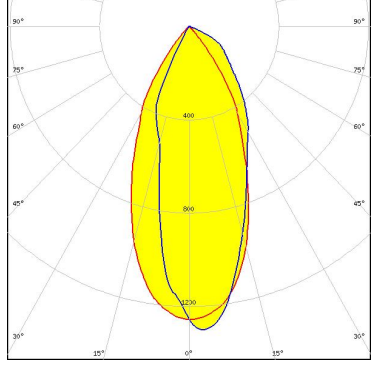
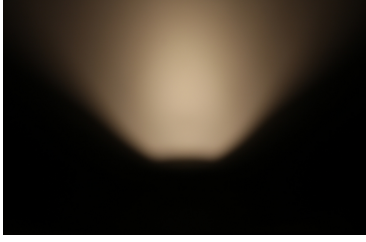
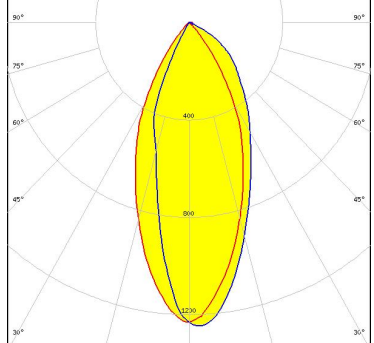
PHOTOMETRIC DATA (MEASURED):

<p>bridgelux.</p> <p>LED V10 Gen7 FWHM Asymmetric Efficiency 90 % Peak intensity 1.200 cd/lm Required components: C13658_CLAMP-VERO13-18 Bender Wirth: 434 Typ L1</p>		
<p>bridgelux.</p> <p>LED V13 Gen7 FWHM Asymmetric Efficiency 91 % Peak intensity 1.300 cd/lm Required components: TE: 2213254-2 + OPTIC CLIP Z50 TYPE1 2213194-1</p>		
<p>bridgelux.</p> <p>LED V15 Gen6 FWHM Asymmetric Efficiency 93 % Peak intensity 1.300 cd/lm Required components: C13658_CLAMP-VERO13-18 Bender Wirth: 456 Typ L2</p>		
<p>bridgelux.</p> <p>LED V22 Gen6 FWHM Asymmetric Efficiency 88 % Peak intensity 1.200 cd/lm Required components: IDEAL: 50-2204-CT + 50-2100AN</p>		

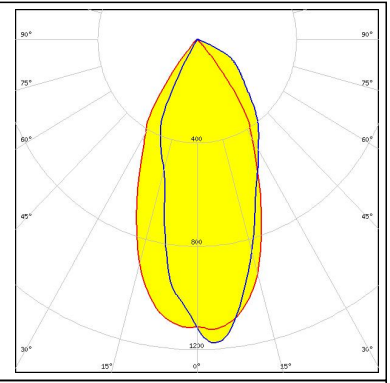
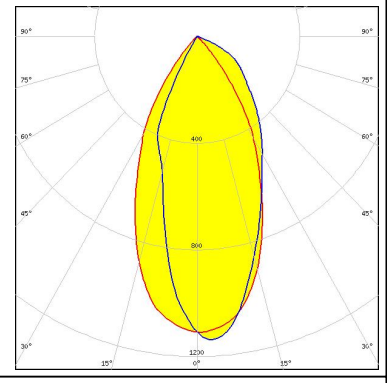
PHOTOMETRIC DATA (MEASURED):

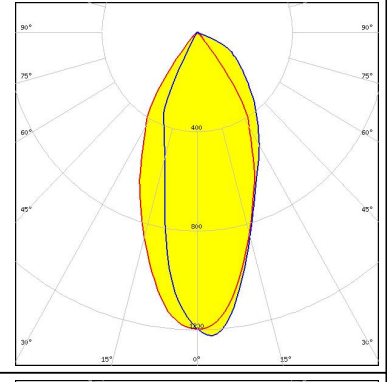
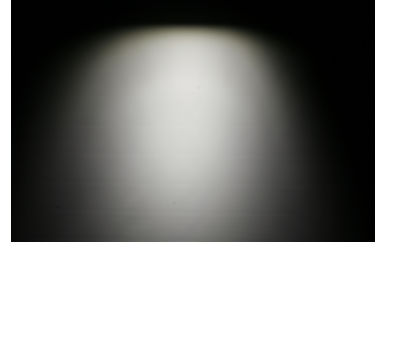
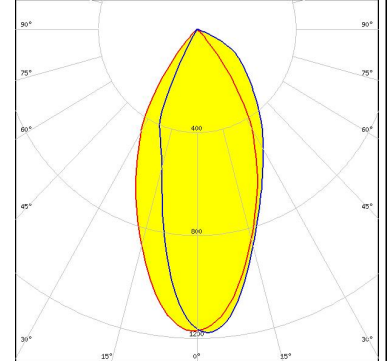
<p>bridgelux.</p> <p>LED Vero SE 13</p> <p>FWHM Asymmetric</p> <p>Efficiency 91 %</p> <p>Peak intensity 1.200 cd/lm</p> <p>Required components:</p> <p> C16402_CLAMP-VEROSE-13-18</p>		
<p>bridgelux.</p> <p>LED Vero SE 18</p> <p>FWHM Asymmetric</p> <p>Efficiency 91 %</p> <p>Peak intensity 1.100 cd/lm</p> <p>Required components:</p> <p> C16402_CLAMP-VEROSE-13-18</p>		
<p>bridgelux.</p> <p>LED VERO13</p> <p>FWHM Asymmetric</p> <p>Efficiency 92 %</p> <p>Peak intensity 1.200 cd/lm</p> <p>Required components:</p> <p> C13658_CLAMP-VERO13-18</p>		
<p>bridgelux.</p> <p>LED VERO18</p> <p>FWHM Asymmetric</p> <p>Efficiency 94 %</p> <p>Peak intensity 1.200 cd/lm</p> <p>Required components:</p> <p> C13658_CLAMP-VERO13-18</p>		

PHOTOMETRIC DATA (MEASURED):

bridgelux

LED VERO29
 FWHM Asymmetric
 Efficiency 92 %
 Peak intensity 1.000 cd/lm
 Required components:
 C13584_CLAMP-VERO29

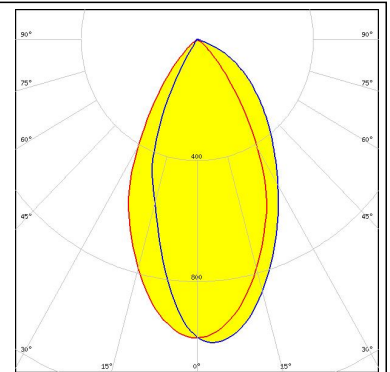

bridgelux

LED VERO29
 FWHM Asymmetric
 Efficiency 85 %
 Peak intensity 0.930 cd/lm
 Required components:
 C13584_CLAMP-VERO29
 F13671_ANGE-RZ-LENS

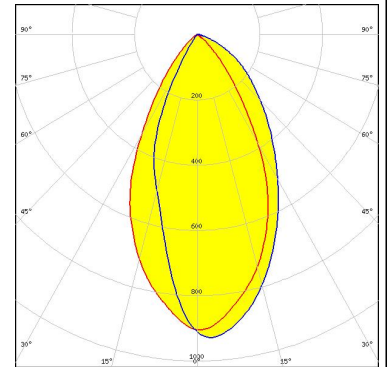

CITIZEN

LED CLL03x/CLU03x
 FWHM Asymmetric
 Efficiency 91 %
 Peak intensity 1.400 cd/lm
 Required components:
 TE: 2213254-2 + OPTIC CLIP Z50 TYPE1 2213194-1

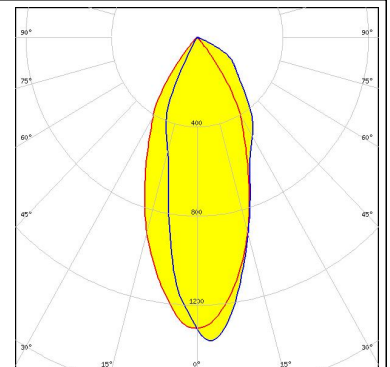
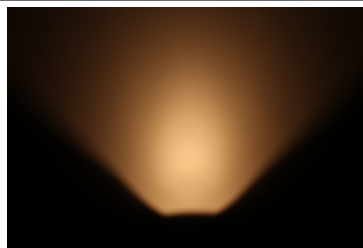

CITIZEN

LED CLL03x/CLU03x
 FWHM Asymmetric
 Efficiency 92 %
 Peak intensity 1.500 cd/lm
 Required components:
 IDEAL: 50-2103CT + 50-2100AN

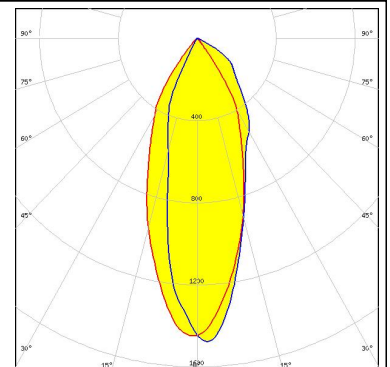
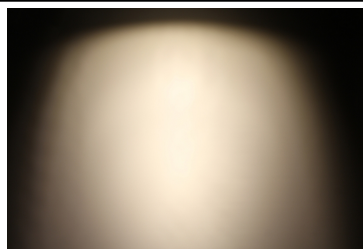

PHOTOMETRIC DATA (MEASURED):

CITIZEN

LED CLL04x/CLU04x
FWHM Asymmetric
Efficiency 88 %
Peak intensity 1.200 cd/lm
Required components:
IDEAL: 50-2204-CT + 50-2100AN

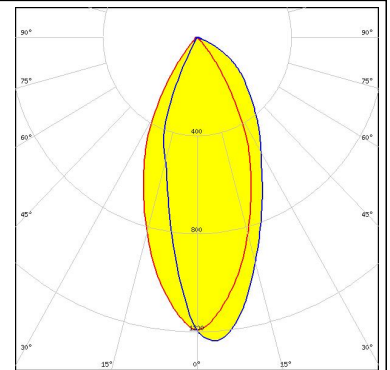

CITIZEN

LED CLL04x/CLU04x
FWHM Asymmetric
Efficiency 91 %
Peak intensity 1.300 cd/lm
Required components:
C13584_CLAMP-VERO29
Bender Wirth: 431 Typ L3

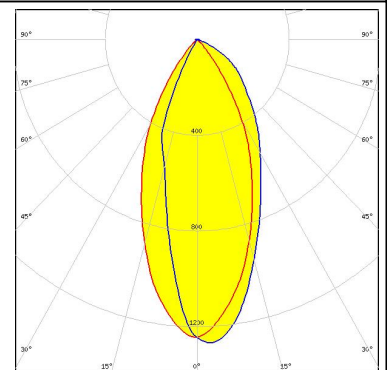
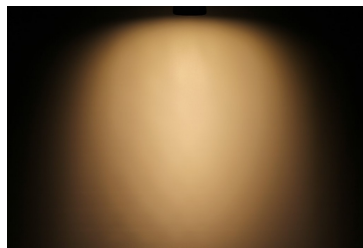

CITIZEN

LED CLU700/701
FWHM Asymmetric
Efficiency 92 %
Peak intensity 1.400 cd/lm
Required components:
C13658_CLAMP-VERO13-18
Bender Wirth: 434 Typ L1

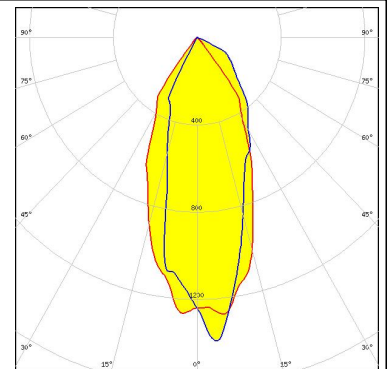

CITIZEN

LED CLU720/721
FWHM Asymmetric
Efficiency 93 %
Peak intensity 1.300 cd/lm
Required components:
TE: 2213254-2 + OPTIC CLIP Z50 TYPE1 2213194-1

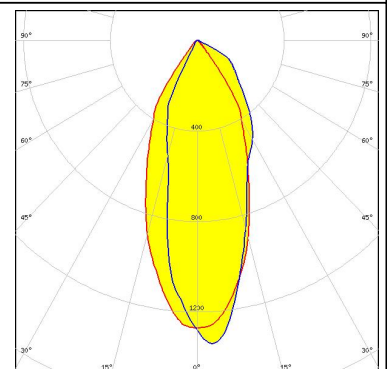

PHOTOMETRIC DATA (MEASURED):

CITIZEN

LED CLU720/721
 FWHM Asymmetric
 Efficiency 92 %
 Peak intensity 1.400 cd/lm
 Required components:
 IDEAL: 50-2103CT + 50-2100AN

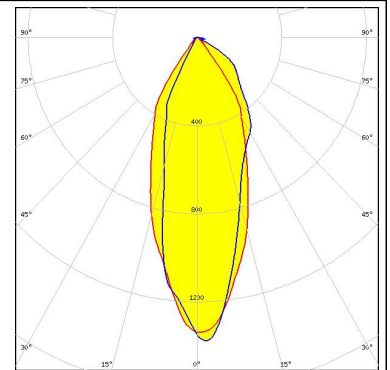

CITIZEN

LED CLU730/731
 FWHM Asymmetric
 Efficiency 88 %
 Peak intensity 1.400 cd/lm
 Required components:
 IDEAL: 50-2204-CT + 50-2100AN

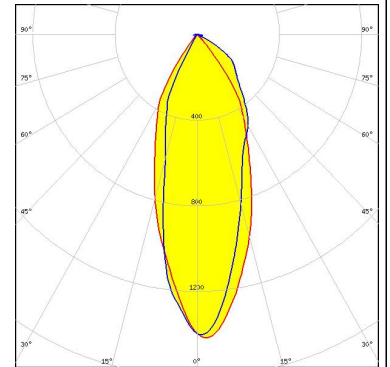
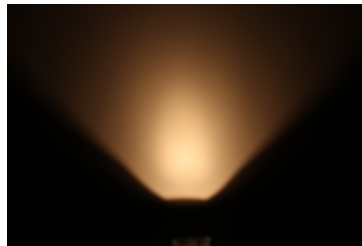

CREE

LED CMA2550
 FWHM Asymmetric
 Efficiency 93 %
 Peak intensity 1.100 cd/lm
 Required components:
 C14036_CLAMP_CXA25-30

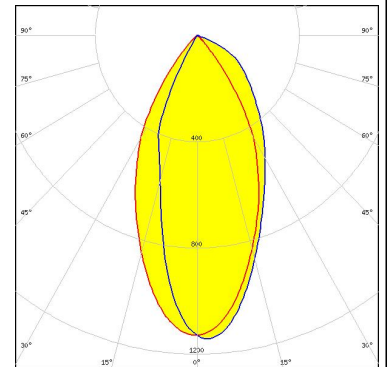
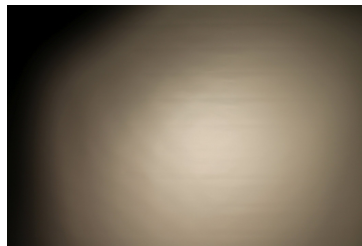

CREE

LED CXA/B 1816 & CXA/B 1820 & CXA 1850
 FWHM Asymmetric
 Efficiency 91 %
 Peak intensity 1.300 cd/lm
 Required components:
 C13658_CLAMP-VERO13-18
 Bender Wirth: 437 Typ L1

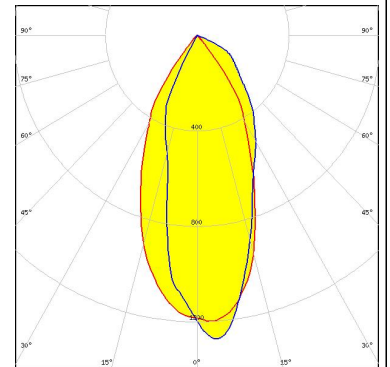
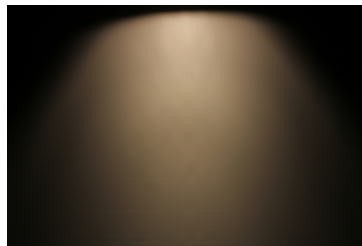

PHOTOMETRIC DATA (MEASURED):



LED CXA/B 1830
FWHM Asymmetric
Efficiency 92 %
Peak intensity 1.160 cd/lm
Required components:
C14123_CLAMP-CXA15-18

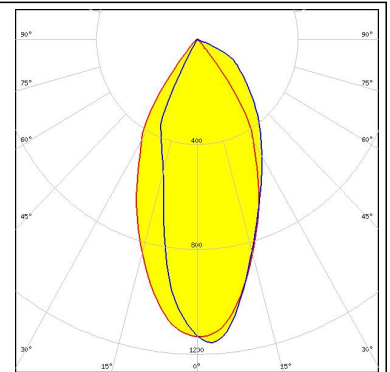

LED CXA/B 25xx
FWHM Asymmetric
Efficiency 92 %
Peak intensity 1.100 cd/lm
Required components:
C14036_CLAMP_CXA25-30

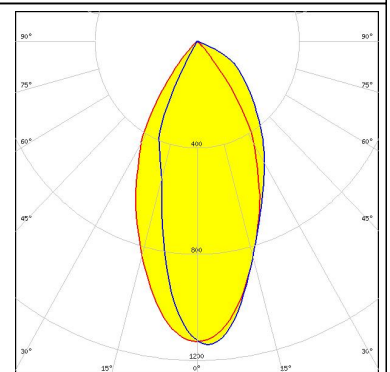
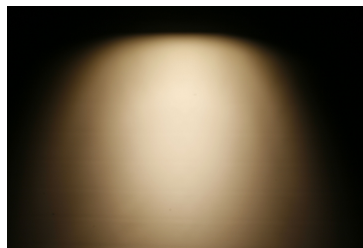

LED CXA/B 30xx
FWHM Asymmetric
Efficiency 91 %
Peak intensity 1.100 cd/lm
Required components:
C14036_CLAMP_CXA25-30

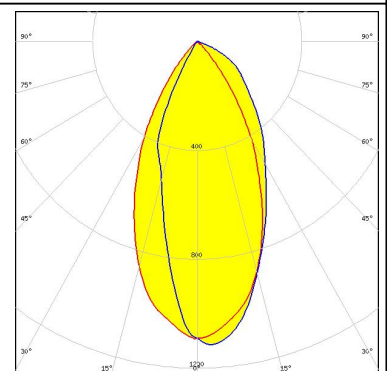
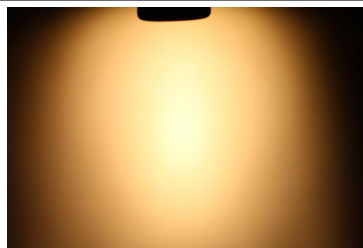

LED LUXEON CoB 1202/1203
FWHM Asymmetric
Efficiency 92 %
Peak intensity 1.300 cd/lm
Required components:
C13658_CLAMP-VERO13-18
Bender Wirth: 438 Typ L1

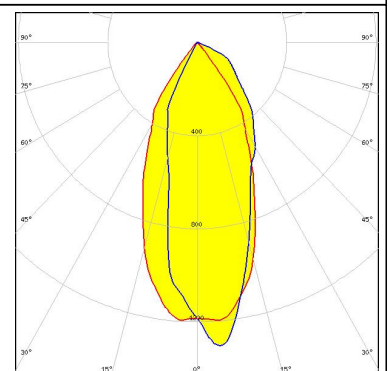
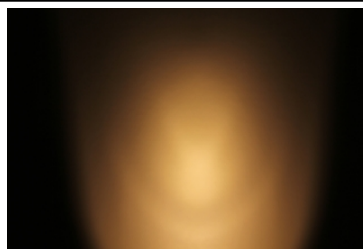

PHOTOMETRIC DATA (MEASURED):

LUMILEDS

LED LUXEON CoB 1208
 FWHM Asymmetric
 Efficiency 89 %
 Peak intensity 1.400 cd/lm
 Required components:
 IDEAL: 50-2100SH + 50-2100AN

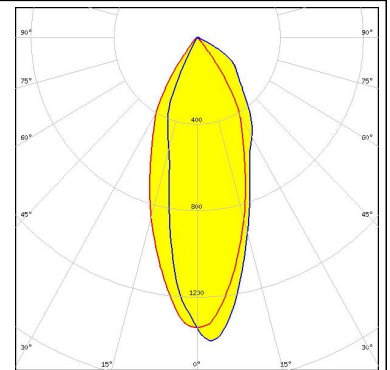
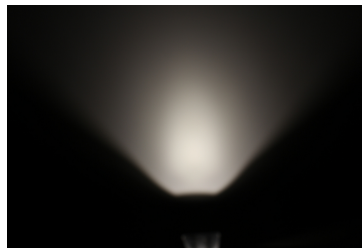

LUMILEDS

LED LUXEON CoB 1208
 FWHM Asymmetric
 Efficiency 91 %
 Peak intensity 1.400 cd/lm
 Required components:
 TE: 2213130-2

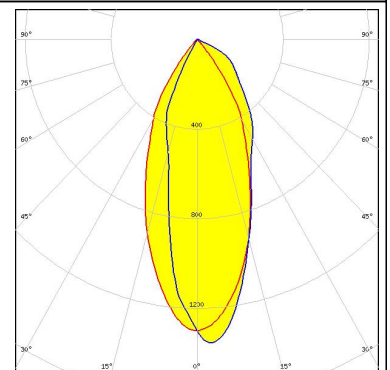
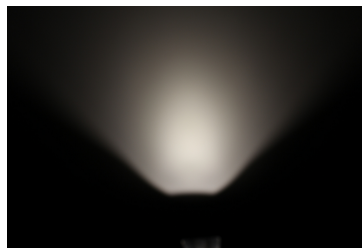

LUMILEDS

LED LUXEON CoB 1211
 FWHM Asymmetric
 Efficiency 92 %
 Peak intensity 1.300 cd/lm
 Required components:
 C13584_CLAMP-VERO29
 Bender Wirth: 431 Typ L3

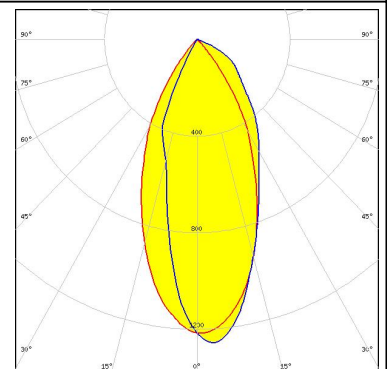
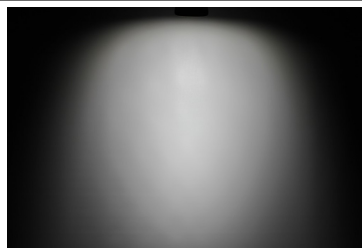

LUMILEDS

LED LUXEON CoB 1211
 FWHM Asymmetric
 Efficiency 88 %
 Peak intensity 1.300 cd/lm
 Required components:
 IDEAL: 50-2204-CT + 50-2100AN

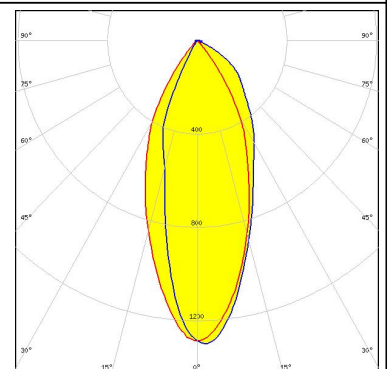
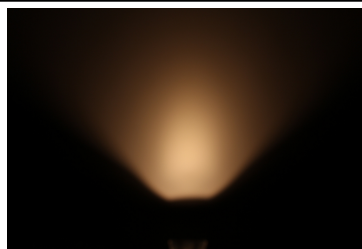

PHOTOMETRIC DATA (MEASURED):



LED LUXEON CoB 1216/1812
 FWHM Asymmetric
 Efficiency 89 %
 Peak intensity 1.200 cd/lm
 Required components:
 IDEAL: 50-2204CT + 50-2100LN

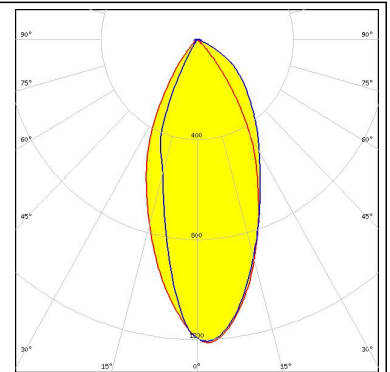
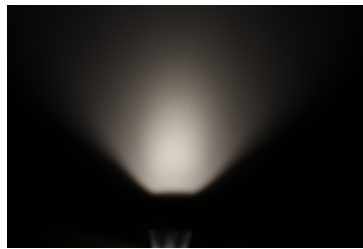

LED CDM-14 (Dim-To-Warm)
 FWHM Asymmetric
 Efficiency 91 %
 Peak intensity 1.200 cd/lm
 Required components:
 C13658_CLAMP-VERO13-18
 Bender Wirth: 491 Typ L2

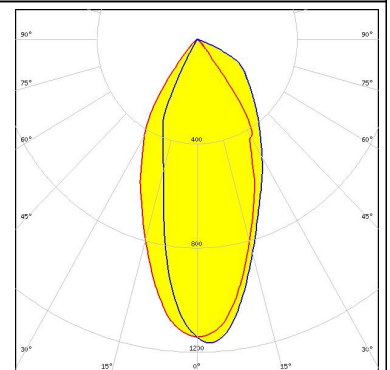
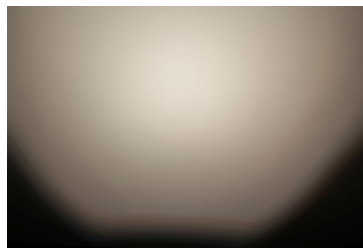

LED CDM-14 (Dim-To-Warm)
 FWHM Asymmetric
 Efficiency 87 %
 Peak intensity 1.000 cd/lm
 Required components:
 C13658_CLAMP-VERO13-18
 F13671_ANGE-RZ-LENS
 Bender Wirth: 491 Typ L2

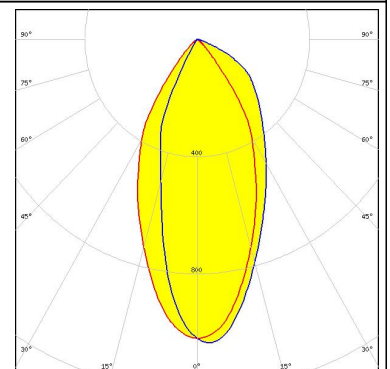
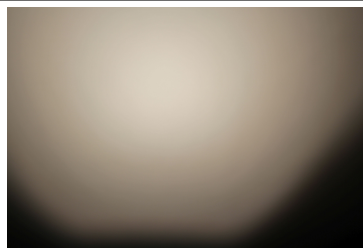

LED CDM-18 (Dim-To-Warm)
 FWHM Asymmetric
 Efficiency 92 %
 Peak intensity 1.150 cd/lm
 Required components:
 C13658_CLAMP-VERO13-18
 Bender Wirth: 491 Typ L2

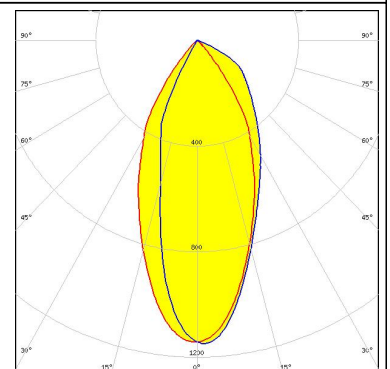

PHOTOMETRIC DATA (MEASURED):



LED CDM-18 (Dim-To-Warm)
 FWHM Asymmetric
 Efficiency 87 %
 Peak intensity 1.000 cd/lm
 Required components:
 C13658_CLAMP-VERO13-18
 F13671_ANGE-RZ-LENS
 Bender Wirth: 491 Typ L2

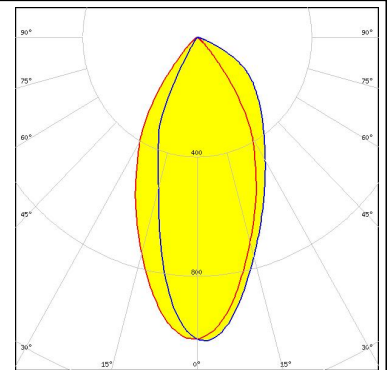

LED CDM-9 (Dim-To-Warm)
 FWHM Asymmetric
 Efficiency 85 %
 Peak intensity 1.200 cd/lm
 Required components:
 C13658_CLAMP-VERO13-18
 F13671_ANGE-RZ-LENS
 Bender Wirth: 490 Typ L1

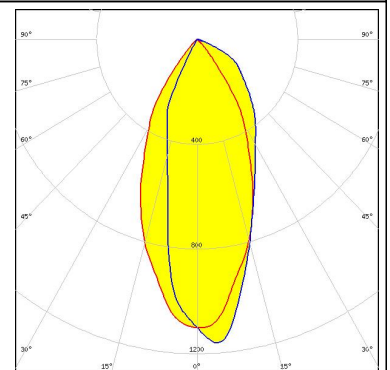
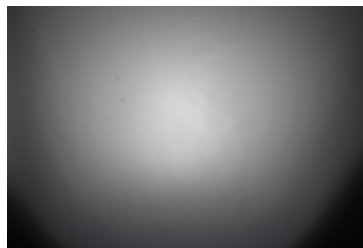

LED CDM-9 (Dim-To-Warm)
 FWHM Asymmetric
 Efficiency 90 %
 Peak intensity 1.300 cd/lm
 Required components:
 C13658_CLAMP-VERO13-18
 Bender Wirth: 490 Typ L1

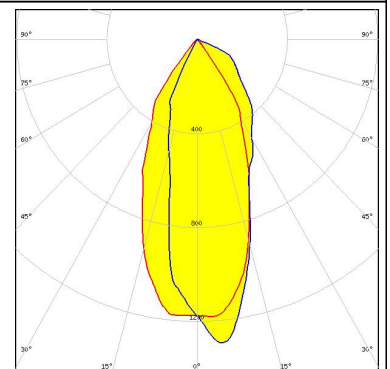
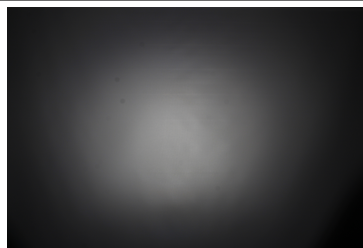

LED CTM-14 (Tunable White)
 FWHM Asymmetric
 Efficiency 92 %
 Peak intensity 1.200 cd/lm
 Required components:
 C13584_CLAMP-VERO29
 Bender Wirth: 442 Typ L3

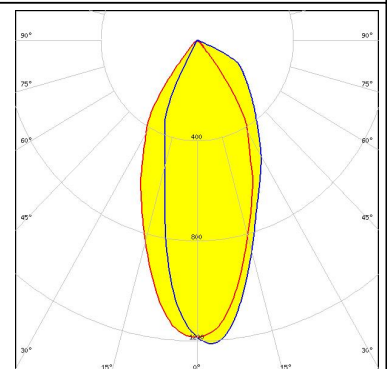
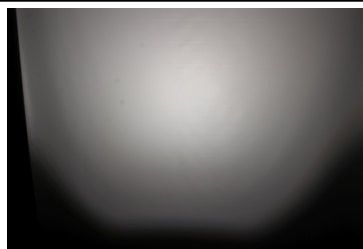

PHOTOMETRIC DATA (MEASURED):



LED CTM-14 (Tunable White)
 FWHM Asymmetric
 Efficiency 87 %
 Peak intensity 1.100 cd/lm
 Required components:
 C13584_CLAMP-VERO29
 F13671_ANGE-RZ-LENS
 Bender Wirth: 442 Typ L3

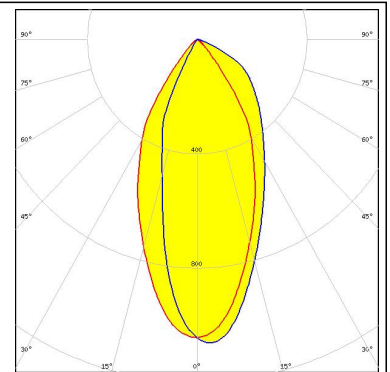

LED CTM-22 (Tunable White)
 FWHM Asymmetric
 Efficiency 90 %
 Peak intensity 1.160 cd/lm
 Required components:
 C13584_CLAMP-VERO29
 Bender Wirth: 494 Typ L3

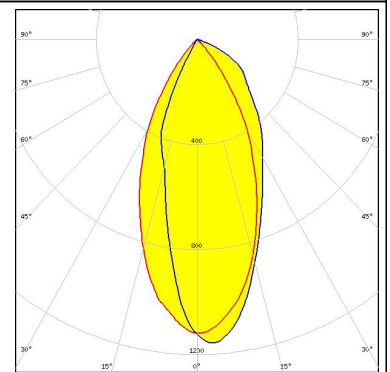
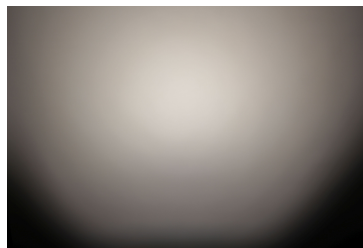

LED COB J-Type
 FWHM Asymmetric
 Efficiency 89 %
 Peak intensity 1.500 cd/lm
 Required components:
 IDEAL: 50-2103NC + 50-2100AN

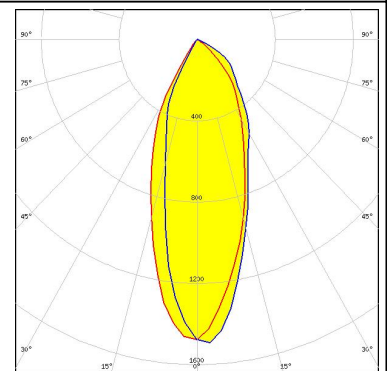
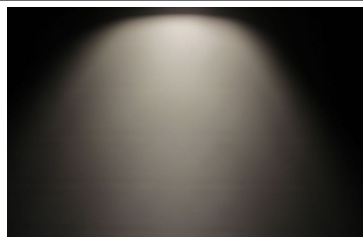

LED COB J-Type
 FWHM Asymmetric
 Efficiency 92 %
 Peak intensity 1.300 cd/lm
 Required components:
 C13658_CLAMP-VERO13-18
 Bender Wirth: 463 Typ L2

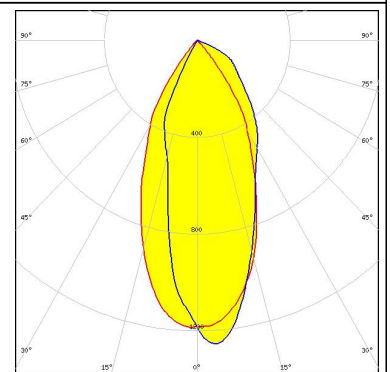
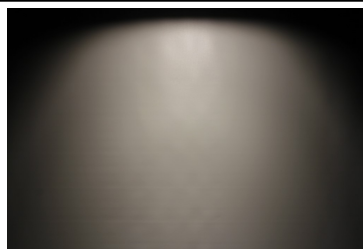

PHOTOMETRIC DATA (MEASURED):



LED COB L-Type (LES 11)
 FWHM Asymmetric
 Efficiency 91 %
 Peak intensity 1.300 cd/lm
 Required components:
 C13658_CLAMP-VERO13-18
 Bender Wirth: 438 Typ L1

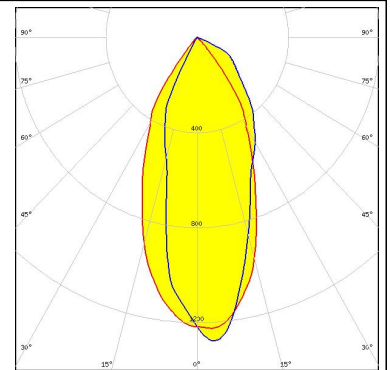
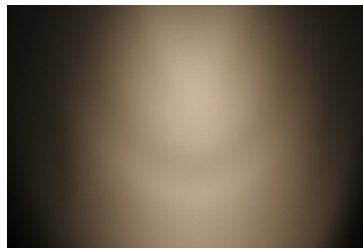

LED COB L-Type (LES 11)
 FWHM Asymmetric
 Efficiency 93 %
 Peak intensity 1.500 cd/lm
 Required components:
 TE: 2213382-2 + OPTIC CLIP Z50 TYPE1 2213194-1

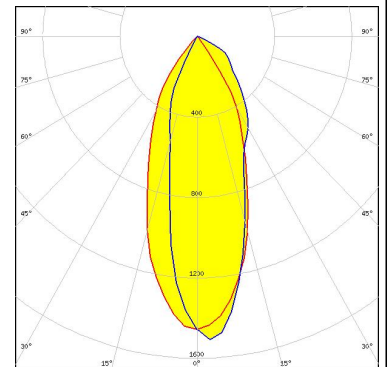

LED COB L-Type (LES 11)
 FWHM Asymmetric
 Efficiency 90 %
 Peak intensity 1.500 cd/lm
 Required components:
 IDEAL: 50-2100NC + 50-2100AN

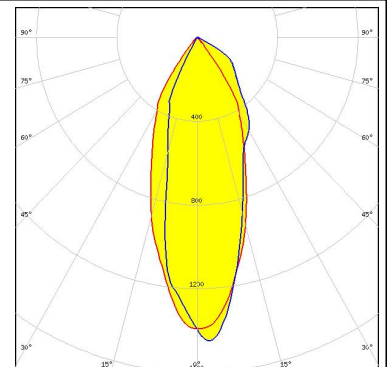

LED COB L-Type (LES 9)
 FWHM Asymmetric
 Efficiency 93 %
 Peak intensity 1.300 cd/lm
 Required components:
 C13658_CLAMP-VERO13-18
 Bender Wirth: 438 Typ L1

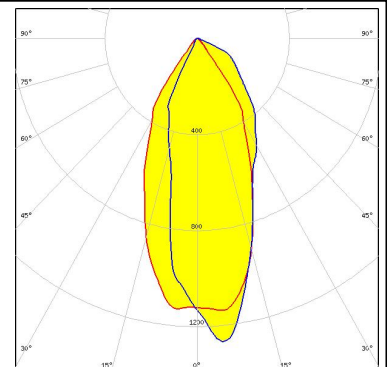

PHOTOMETRIC DATA (MEASURED):

OSRAM

LED PrevaLED Core Z4 LES19
 FWHM Asymmetric
 Efficiency 91 %
 Peak intensity 1.400 cd/lm
 Required components:
 TE: OPTIC CLIP Z50 TYPE1 2213194-1

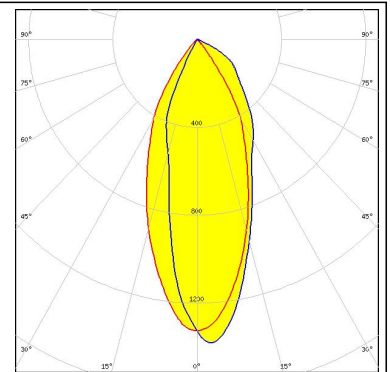
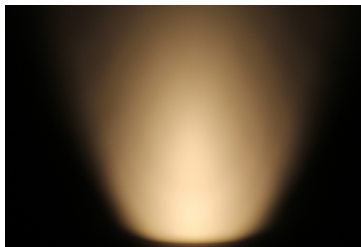

OSRAM

Opto Semiconductors

LED Soleriq S13
 FWHM Asymmetric
 Efficiency 93 %
 Peak intensity 1.400 cd/lm
 Required components:
 TE: 2213401-2 + OPTIC CLIP Z50 TYPE1 2213194-1

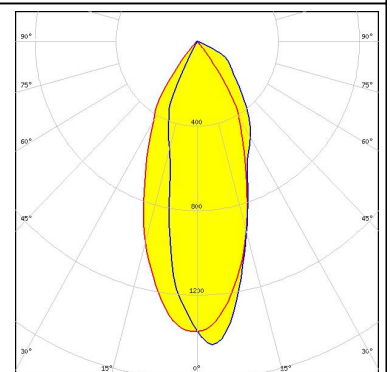
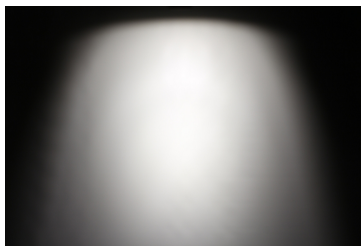

OSRAM

Opto Semiconductors

LED Soleriq S13
 FWHM Asymmetric
 Efficiency 91 %
 Peak intensity 1.300 cd/lm
 Required components:
 C13658_CLAMP-VERO13-18
 Bender Wirth: 437 Typ L1

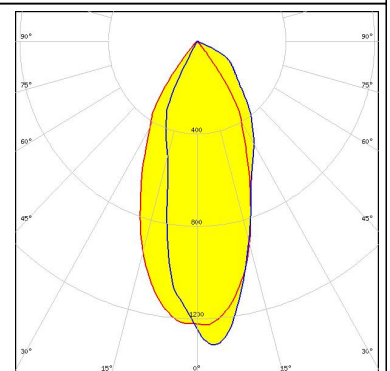
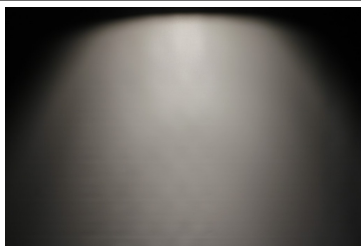

OSRAM

Opto Semiconductors

LED Soleriq S13 Gen2
 FWHM Asymmetric
 Efficiency 89 %
 Peak intensity 1.400 cd/lm
 Required components:
 IDEAL: 50-2103CT + 50-2100AN

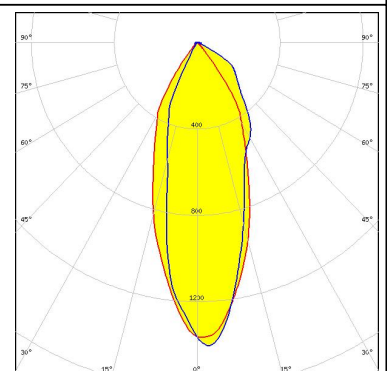
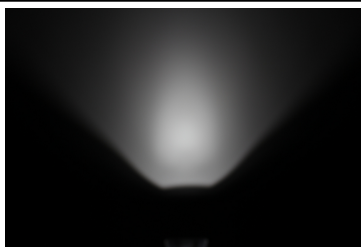

PHOTOMETRIC DATA (MEASURED):

OSRAM
Opto Semiconductors

LED Soleriq S13 Gen2

FWHM Asymmetric

Efficiency 91 %

Peak intensity 1.300 cd/lm

Required components:

TE: 2213254-2 + OPTIC CLIP Z50 TYPE1 2213194-1

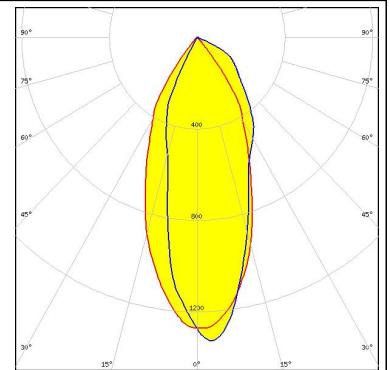
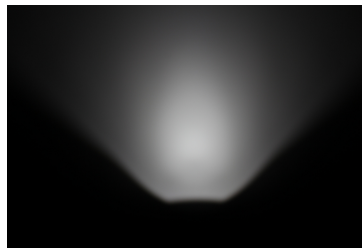

OSRAM
Opto Semiconductors

LED Soleriq S19

FWHM Asymmetric

Efficiency 91 %

Peak intensity 1.300 cd/lm

Required components:

C13584_CLAMP-VERO29

Bender Wirth: 462 Typ L3

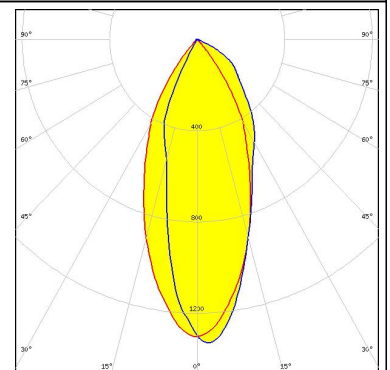
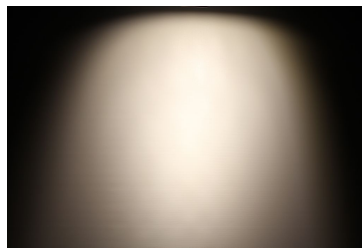

OSRAM
Opto Semiconductors

LED Soleriq S19

FWHM Asymmetric

Efficiency 93 %

Peak intensity 1.400 cd/lm

Required components:

TE: 2213407-2 + OPTIC CLIP Z50 TYPE1 2213194-1

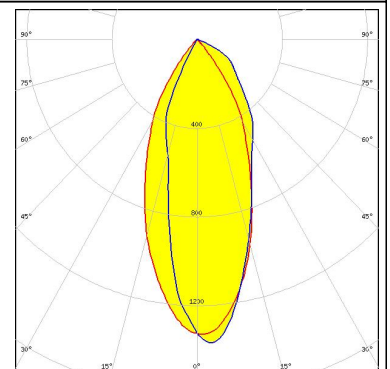
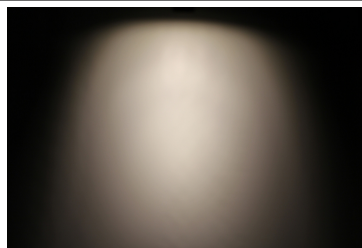

PHILIPS

LED Fortimo SLM L09 Standard

FWHM Asymmetric

Efficiency 91 %

Peak intensity 1.360 cd/lm

Required components:

TE: OPTIC CLIP Z50 TYPE1 2213194-1

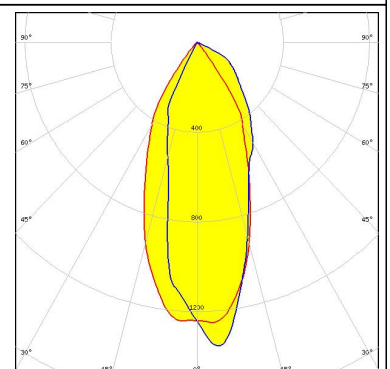
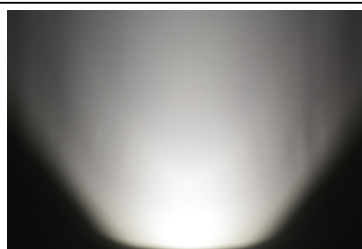

PHOTOMETRIC DATA (MEASURED):

PHILIPS

LED Fortimo SLM L13 Standard
FWHM Asymmetric
Efficiency 91 %
Peak intensity 1.420 cd/lm
Required components:
TE: OPTIC CLIP Z50 TYPE1 2213194-1

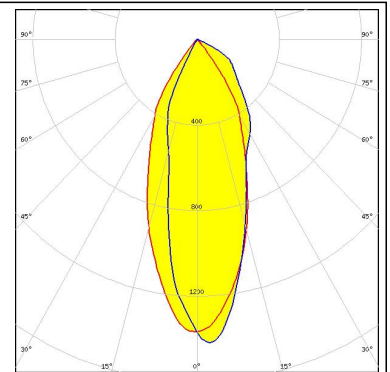
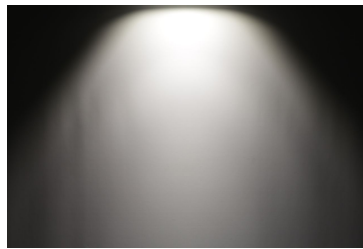

PHILIPS

LED Fortimo SLM L15 Standard
FWHM Asymmetric
Efficiency 90 %
Peak intensity 1.350 cd/lm
Required components:
TE: OPTIC CLIP Z50 TYPE1 2213194-1

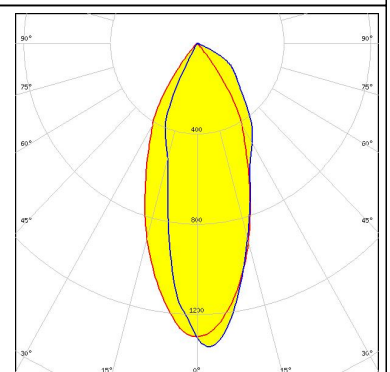
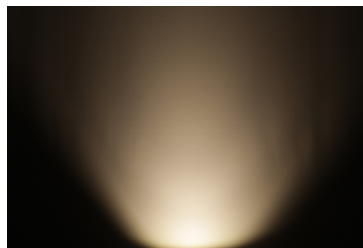

PHILIPS

LED Fortimo SLM L19 Standard
FWHM Asymmetric
Efficiency 88 %
Peak intensity 1.260 cd/lm
Required components:
TE: OPTIC CLIP Z50 TYPE1 2213194-1

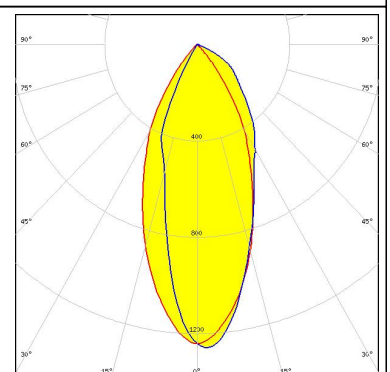
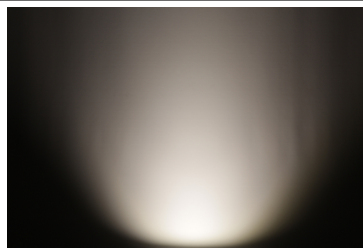

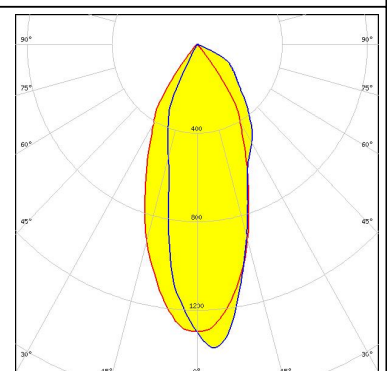

SAMSUNG

LED LC040C
FWHM Asymmetric
Efficiency 91 %
Peak intensity 1.400 cd/lm
Required components:
TE: 2213382-2 + OPTIC CLIP Z50 TYPE1 2213194-1

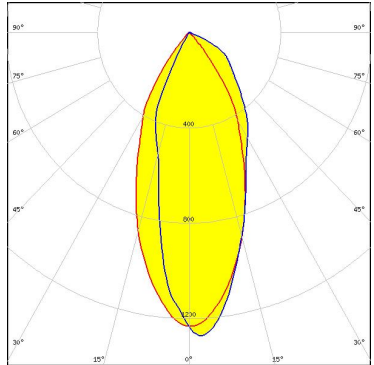

PHOTOMETRIC DATA (MEASURED):

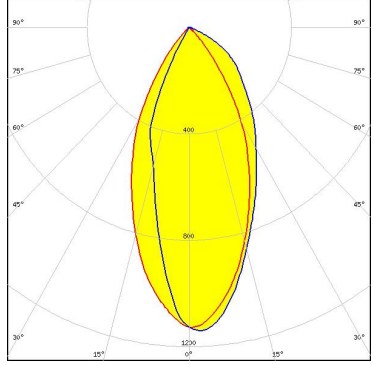
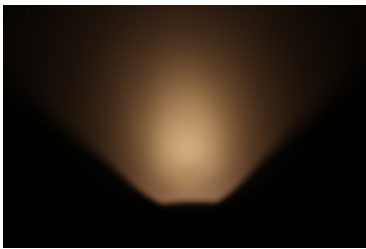
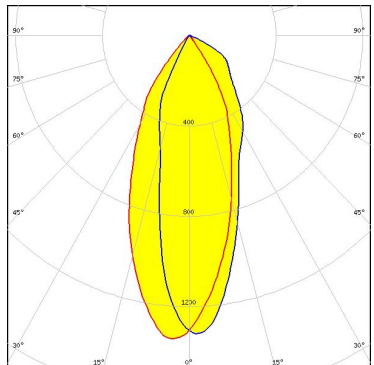
<p>SEOL SEOUL SEMICONDUCTOR</p> <p>LED MJT COB LES 14.5 FWHM Asymmetric Efficiency 91 % Peak intensity 1.300 cd/lm Required components: TE: 2213254-2 + OPTIC CLIP Z50 TYPE1 2213194-1</p>		
<p>SEOL SEOUL SEMICONDUCTOR</p> <p>LED MJT COB LES 22 FWHM Asymmetric Efficiency 89 % Peak intensity 1.100 cd/lm Required components: C13584_CLAMP-VERO29 Bender Wirth: 431 Typ L3</p>		
<p>VS LIGHTING SOLUTIONS</p> <p>LED WU-M-484 FWHM Asymmetric Efficiency 88 % Peak intensity 1.400 cd/lm Required components: TE: OPTIC CLIP Z50 TYPE1 2213194-1</p>		

PHOTOMETRIC DATA (SIMULATED):

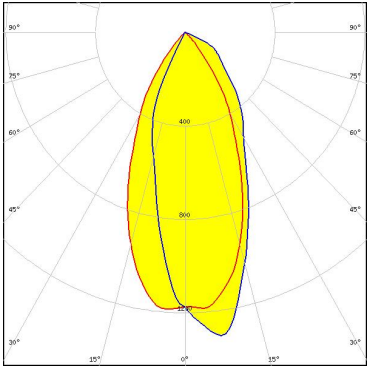
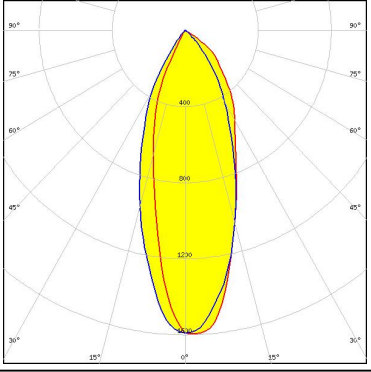
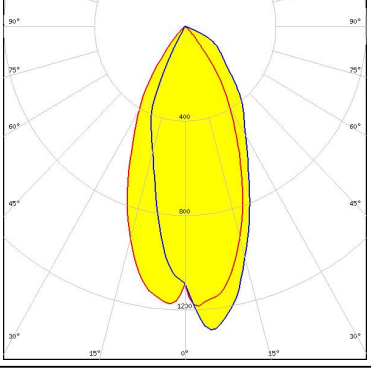
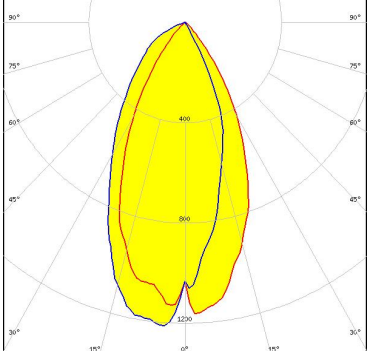
<p>bridgelux.</p> <p>LED V10 Gen7</p> <p>FWHM Asymmetric</p> <p>Efficiency 92 %</p> <p>Peak intensity 1.310 cd/lm</p> <p>Required components: C13658_CLAMP-VERO13-18 Bender Wirth: 434 Typ L1</p>	
<p>bridgelux.</p> <p>LED V13 Gen7</p> <p>FWHM Asymmetric</p> <p>Efficiency 92 %</p> <p>Peak intensity 1.600 cd/lm</p> <p>Required components: IDEAL: 50-2103CT + 50-2100AN</p>	
<p>bridgelux.</p> <p>LED V13 Gen7</p> <p>FWHM Asymmetric</p> <p>Efficiency 92 %</p> <p>Peak intensity 1.330 cd/lm</p> <p>Required components: C13658_CLAMP-VERO13-18 Bender Wirth: 477 Typ L1</p>	
<p>bridgelux.</p> <p>LED V22 Gen7</p> <p>FWHM Asymmetric</p> <p>Efficiency 94 %</p> <p>Peak intensity 1.248 cd/lm</p> <p>Required components: C13584_CLAMP-VERO29 Bender Wirth: 431 Typ L3</p>	

PHOTOMETRIC DATA (SIMULATED):

TRIDONIC

LED SLE G6 LES15

FWHM Asymmetric

Efficiency 91 %

Peak intensity 1.400 cd/lm

Required components:

TE: 2213254-2 + OPTIC CLIP Z50 TYPE1 2213194-1

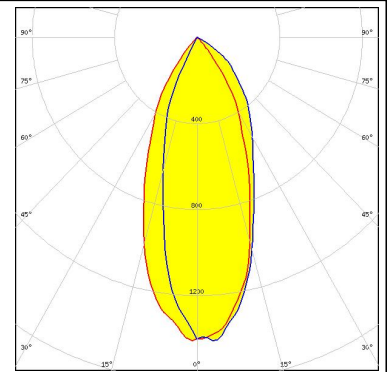

TRIDONIC

LED SLE G6 LES17

FWHM Asymmetric

Efficiency 88 %

Peak intensity 1.280 cd/lm

Required components:

TE: 2213254-2 + OPTIC CLIP Z50 TYPE1 2213194-1

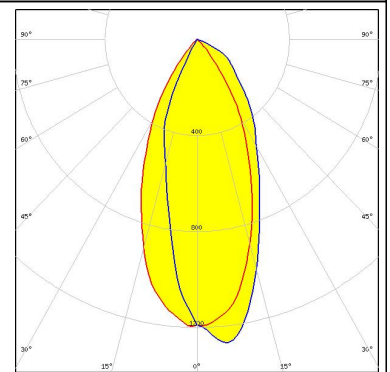

GENERAL INFORMATION:

NOTE: The typical beam angle will be changed by different color, chip size and chip position tolerance. The typical total beam angle is the full angle measured where the luminous intensity is half of the peak value.

Due to use of high power COB's with this product, special attention to proper thermal design is highly recommended. LEDiL has no liability for direct, indirect or consecutive damages arising from the LEDiL products being used outside of the recommended temperature range.

MATERIALS:

As part of our continuous research and improvement processes, and to ensure the best possible quality and availability of our products, LEDiL reserves the right to change material grades without notice.

PRODUCT DATA USER AGREEMENT AND DISCLAIMER:

The measured data in the provided downloadable LEDiL Product Datasheets and Mechanical 2D-Drawings is rounded and provided as reference for planning. LEDiL Oy's optical specifications have been verified by conducting performance testing of the products in accordance with the company's quality system. The reported data are averaged results of multiple measurements with typical variation. LEDiL Oy reserves the right to without prior notification make changes and improvements to its products.

LEDiL Oy assumes neither warranty, nor guarantee nor any other liability of any kind for the contents and correctness of the provided data. The provided data has been generated with highest diligence but the provided data may in reality not represent the complete possible variation range of all intrinsic parameters. Therefore, in certain cases a deviation from the provided data could occur.

LEDiL Oy reserves the right to undertake technical changes of its products without further notification which could lead to changes in the provided data. LEDiL Oy assumes no liability of any kind for the possible deviation from any provided data or any other damage resulting from the usage of the provided data.

The user agrees to this disclaimer and user agreement with the download or usage of the provided files.

LEDiL Oy

Joensuunkatu 13
FI-24240 SALO
Finland

LEDiL Inc.

228 West Page Street
Suite D
Sycamore IL 60178
USA

Local sales and technical support

www.ledil.com/where_to_buy

Shipping locations

Salo, Finland
Hong Kong, China

Distribution Partners

www.ledil.com/where_to_buy