



Chipsmall Limited consists of a professional team with an average of over 10 year of expertise in the distribution of electronic components. Based in Hongkong, we have already established firm and mutual-benefit business relationships with customers from,Europe,America and south Asia,supplying obsolete and hard-to-find components to meet their specific needs.

With the principle of “Quality Parts,Customers Priority,Honest Operation,and Considerate Service”,our business mainly focus on the distribution of electronic components. Line cards we deal with include Microchip,ALPS,ROHM,Xilinx,Pulse,ON,Everlight and Freescale. Main products comprise IC,Modules,Potentiometer,IC Socket,Relay,Connector.Our parts cover such applications as commercial,industrial, and automotives areas.

We are looking forward to setting up business relationship with you and hope to provide you with the best service and solution. Let us make a better world for our industry!



Contact us

Tel: +86-755-8981 8866 Fax: +86-755-8427 6832

Email & Skype: info@chipsmall.com Web: www.chipsmall.com

Address: A1208, Overseas Decoration Building, #122 Zhenhua RD., Futian, Shenzhen, China



SYSMAC
Programmable Controllers
C200HS

INSTALLATION GUIDE

OMRON

C200HS Programmable Controllers

Installation Guide

Revised March 2003

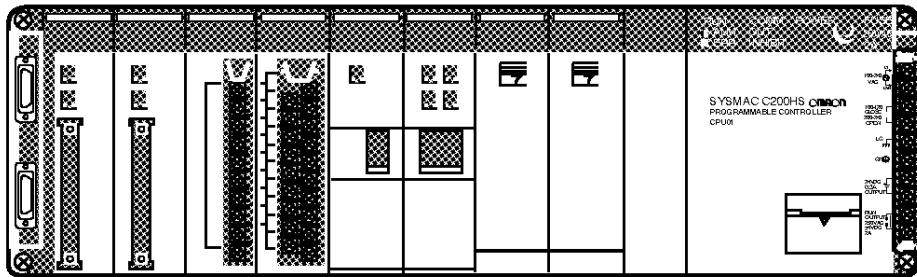



Notice:

OMRON products are manufactured for use according to proper procedures by a qualified operator and only for the purposes described in this manual.

The following conventions are used to indicate and classify precautions in this manual. Always heed the information provided with them. Failure to heed precautions can result in injury to people or damage to property.

 **DANGER** Indicates an imminently hazardous situation which, if not avoided, will result in death or serious injury.

 **WARNING** Indicates a potentially hazardous situation which, if not avoided, could result in death or serious injury.

 **Caution** Indicates a potentially hazardous situation which, if not avoided, may result in minor or moderate injury, or property damage.

OMRON Product References

All OMRON products are capitalized in this manual. The word “Unit” is also capitalized when it refers to an OMRON product, regardless of whether or not it appears in the proper name of the product.

The abbreviation “Ch,” which appears in some displays and on some OMRON products, often means “word” and is abbreviated “Wd” in documentation in this sense.

The abbreviation “PC” means Programmable Controller and is not used as an abbreviation for anything else.

Visual Aids

The following headings appear in the left column of the manual to help you locate different types of information.

Note Indicates information of particular interest for efficient and convenient operation of the product.

1, 2, 3... 1. Indicates lists of one sort or another, such as procedures, checklists, etc.

© OMRON, 1993

All rights reserved. No part of this publication may be reproduced, stored in a retrieval system, or transmitted, in any form, or by any means, mechanical, electronic, photocopying, recording, or otherwise, without the prior written permission of OMRON.

No patent liability is assumed with respect to the use of the information contained herein. Moreover, because OMRON is constantly striving to improve its high-quality products, the information contained in this manual is subject to change without notice. Every precaution has been taken in the preparation of this manual. Nevertheless, OMRON assumes no responsibility for errors or omissions. Neither is any liability assumed for damages resulting from the use of the information contained in this publication.

TABLE OF CONTENTS

PRECAUTIONS	xi
1 Intended Audience	xii
2 General Precautions	xii
3 Safety Precautions	xii
4 Operating Environment Precautions	xii
5 Application Precautions	xiii
6 Conformance to EC Directives	xiv
SECTION 1	
Introduction	1
1-1 What is a Control System?	2
1-2 The Role of the PC	4
1-3 How Does a PC Work?	5
1-4 New C200HS Features	8
1-5 Comparisons Between C200HS and C200H	11
1-6 Compatibility of C200HS and C200H Devices	13
SECTION 2	
System Configuration and Unit Description	15
2-1 System Configuration	16
2-2 CPUs	18
2-3 Expansion I/O Racks	24
2-4 Power Supply Unit	25
2-5 I/O Units	26
SECTION 3	
Installation	33
3-1 Installation Environment	34
3-2 Mounting Units to the Backplane	35
3-3 Installing Racks	39
3-4 I/O Connecting Cable	40
3-5 Mounting Requirements	41
3-6 Installing Memory Cassettes	43
SECTION 4	
Wiring	45
4-1 Power Supply Wiring	46
4-2 AC Power Supply	46
4-3 DC Power Supply	47
4-4 RUN Output Terminals	48
4-5 Grounding	48
4-6 Backplane Insulation Plate	49
4-7 Standard I/O Unit Wiring	50
4-8 Input Circuits	53
4-9 Output Circuits	54
4-10 External Wiring	57
4-11 System Design and Safety Considerations	57
SECTION 5	
Peripheral Devices and System Expansion	61
5-1 Programming Console	62
5-2 Checking Initial C200HS Operation	64
5-3 Expanding the System	64
5-4 Special I/O Units	67
5-5 Ladder Support Software (LSS)	73
5-6 SYSMAC Support Software (SSS)	73

TABLE OF CONTENTS

SECTION 6	
Troubleshooting	75
6-1 Alarm Indicators	76
6-2 Programmed Alarms and Error Messages	76
6-3 Reading and Clearing Errors and Messages	76
6-4 Error Messages	77
6-5 CPU Racks and Expansion I/O Racks	81
6-6 Input Units	82
6-7 Output Units	83
SECTION 7	
Inspection and Maintenance	85
7-1 CPU and Power Supply Fuses	86
7-2 Output Unit Fuses	86
7-3 Output Unit Relays	87
7-4 Batteries	90
Appendices	
A Standard Models	93
B Specifications	103
Glossary	205
Index	209
Revision History	213

About this Manual:

This manual describes the installation of C200HS Programmable Controllers, and it includes the sections described below. Programming and operating information is provided in the *C200HS Operation Manual*.

Please read this manual completely and be sure you understand the information provided before attempting to install a C200HS PC. **Be sure to read the precautions in the following section.**

Section 1 is an introduction to Programmable Controllers (or PCs). General information is provided on PCs and how they work. This section also provides an overview of the new features of the C200HS and the major differences between the C200HS and the C200H.

Section 2 provides a description of all the components of the C200HS. The names of all the individual parts of each Unit are given.

Section 3 describes how to install a PC System, including mounting the various Units and configuring the System.

Section 4 provides the information necessary to wire a C200HS System.

Section 5 provides general information about the Programming Console, LSS, SSS, and ways in which the C200HS System can be expanded for more versatility.

Section 6 provides information on hardware and software errors that occur during PC operation. It also provides troubleshooting charts for CPU Racks, Expansion I/O Racks, Input Units, and Output Units.

Section 7 covers maintenance and inspection, and explains how to replace consumable components such as fuses, relays, and batteries.

Appendixes, a **Glossary**, and an **Index** are also provided.



WARNING Failure to read and understand the information provided in this manual may result in personal injury or death, damage to the product, or product failure. Please read each section in its entirety and be sure you understand the information provided in the section and related sections before attempting any of the procedures or operations given.

PRECAUTIONS

This section provides general precautions for using the Programmable Controller (PC) and related devices.

The information contained in this section is important for the safe and reliable application of the PC. You must read this section and understand the information contained before attempting to set up or operate a PC system.

1 Intended Audience	xii
2 General Precautions	xii
3 Safety Precautions	xii
4 Operating Environment Precautions	xii
5 Application Precautions	xiii
6 Conformance to EC Directives	xiv

1 Intended Audience

This manual is intended for the following personnel, who must also have knowledge of electrical systems (an electrical engineer or the equivalent).

- Personnel in charge of installing FA systems.
- Personnel in charge of designing FA systems.
- Personnel in charge of managing FA systems and facilities.

2 General Precautions

The user must operate the product according to the performance specifications described in the operation manuals.

Before using the product under conditions which are not described in the manual or applying the product to nuclear control systems, railroad systems, aviation systems, vehicles, combustion systems, medical equipment, amusement machines, safety equipment, and other systems, machines, and equipment that may have a serious influence on lives and property if used improperly, consult your OMRON representative.

Make sure that the ratings and performance characteristics of the product are sufficient for the systems, machines, and equipment, and be sure to provide the systems, machines, and equipment with double safety mechanisms.

This manual provides information for programming and operating OMRON PCs. Be sure to read this manual before attempting to use the software and keep this manual close at hand for reference during operation.

 **WARNING** It is extremely important that a PC and all PC Units be used for the specified purpose and under the specified conditions, especially in applications that can directly or indirectly affect human life. You must consult with your OMRON representative before applying a PC System to the abovementioned applications.

3 Safety Precautions

 **WARNING** Never attempt to disassemble any Units while power is being supplied. Doing so may result in serious electrical shock or electrocution.

 **WARNING** Never touch any of the terminals while power is being supplied. Doing so may result in serious electrical shock or electrocution.

4 Operating Environment Precautions

Do not operate the control system in the following places.

- Where the PC is exposed to direct sunlight.
- Where the ambient temperature is below 0°C or over 55°C.
- Where the PC may be affected by condensation due to radical temperature changes.
- Where the ambient humidity is below 10% or over 90%.
- Where there is any corrosive or inflammable gas.
- Where there is excessive dust, saline air, or metal powder.
- Where the PC is affected by vibration or shock.
- Where any water, oil, or chemical may splash on the PC.

-  **Caution** The operating environment of the PC System can have a large effect on the longevity and reliability of the system. Improper operating environments can lead to malfunction, failure, and other unforeseeable problems with the PC System. Be sure that the operating environment is within the specified conditions at installation and remains within the specified conditions during the life of the system.

5 Application Precautions

Observe the following precautions when using the PC.

-  **WARNING** Failure to abide by the following precautions could lead to serious or possibly fatal injury. Always heed these precautions.

- Always ground the system to 100 Ω or less when installing the system to protect against electrical shock.
- Always turn off the power supply to the PC before attempting any of the following. Performing any of the following with the power supply turned on may lead to electrical shock:
 - Mounting or removing any Units (e.g., I/O Units, CPU Unit, etc.) or memory cassettes.
 - Assembling any devices or racks.
 - Connecting or disconnecting any cables or wiring.

-  **Caution** Failure to abide by the following precautions could lead to faulty operation or the PC or the system or could damage the PC or PC Units. Always heed these precautions.

- Use the Units only with the power supplies and voltages specified in the operation manuals. Other power supplies and voltages may damage the Units.
- Take measures to stabilize the power supply to conform to the rated supply if it is not stable.
- Provide circuit breakers and other safety measures to provide protection against shorts in external wiring.
- Do not apply voltages exceeding the rated input voltage to Input Units. The Input Units may be destroyed.
- Do not apply voltages exceeding the maximum switching capacity to Output Units. The Output Units may be destroyed.
- Always disconnect the LG terminal when performing withstand voltage tests.
- Install all Units according to instructions in the operation manuals. Improper installation may cause faulty operation.
- Provide proper shielding when installing in the following locations:
 - Locations subject to static electricity or other sources of noise.
 - Locations subject to strong electromagnetic fields.
 - Locations subject to possible exposure to radiation.
 - Locations near to power supply lines.
- Be sure to tighten Backplane screws, terminal screws, and cable connector screws securely.
- Do not attempt to take any Units apart, to repair any Units, or to modify any Units in any way.

-  **Caution** The following precautions are necessary to ensure the general safety of the system. Always heed these precautions.

- Provide double safety mechanisms to handle incorrect signals that can be generated by broken signal lines or momentary power interruptions.
- Provide external interlock circuits, limit circuits, and other safety circuits in addition to any provided within the PC to ensure safety.

6 Conformance to EC Directives

Observe the following precautions when installing the C200HS-CPU01-EC and C200HS-CPU21-EC that conform to the EC Directives.

- 1, 2, 3...**
1. Since the C200HS PC is defined as an open type, be sure to install it inside a panel.
 2. Provide reinforced insulation or double insulation for the DC power source connected to the DC I/O Unit and for the CPU with a DC power source.
 3. The C200HS PC that conforms to the EC Directives also conforms, as an individual unit, to the Common Emission Standard (EN50081-2) of the EC Directives. When incorporated into a device, however, the C200HS PC may not satisfy this Standard due to the noise produced by the contact output when it switches on and off. In such a case, it will be necessary to take countermeasures such as connecting a surge or arc killer, or providing an external means of protection for the PC. The countermeasures taken to satisfy the Standard vary depending on the load devices, wiring, machinery configuration, etc. Described on page 130 are examples of countermeasures to be taken to reduce the noise.

Criteria for Taking Countermeasures

(Refer to EN50081-2 for details.)

Countermeasures are not required if the frequency of load switching for the whole system with the PC included is less than 5 times per minute.

Countermeasures are not required if the frequency of load switching for the whole system with the PC included is more than 5 times per minute.

SECTION 1

Introduction

This section provides general information about Programmable Controllers (PCs) and how they fit into a Control System. It also provides an overview of the new features of the C200HS and the major differences between the C200HS and the C200H.

1-1	What is a Control System?	2
1-2	The Role of the PC	4
1-2-1	Input Devices	4
1-2-2	Output Devices	4
1-3	How Does a PC Work?	5
1-4	New C200HS Features	8
1-4-1	Improved Memory Capabilities	8
1-4-2	Faster Execution Times	9
1-4-3	Larger Instruction Set	9
1-4-4	Expanded Number of I/O Points	9
1-4-5	Wide Selection of Special I/O Units	9
1-4-6	Improved Interrupt Functions	9
1-4-7	SYSMAC NET Link and SYSMAC LINK Capabilities	10
1-4-8	Built-in RS-232C Connector	10
1-4-9	More Flexible PC Settings	10
1-4-10	Debugging and Maintenance	10
1-4-11	Peripheral Devices	10
1-5	Comparisons Between C200HS and C200H	11
1-6	Compatibility of C200HS and C200H Devices	13

1-1 What is a Control System?

A Control System is the electronic equipment needed to control a particular process. It may include everything from a process control computer, if one is used, to the factory computer, down through the PCs (and there may be many of them networked together) and then on down through the network to the control components: the switches, stepping motors, solenoids, and sensors which monitor and control the mechanical operations.

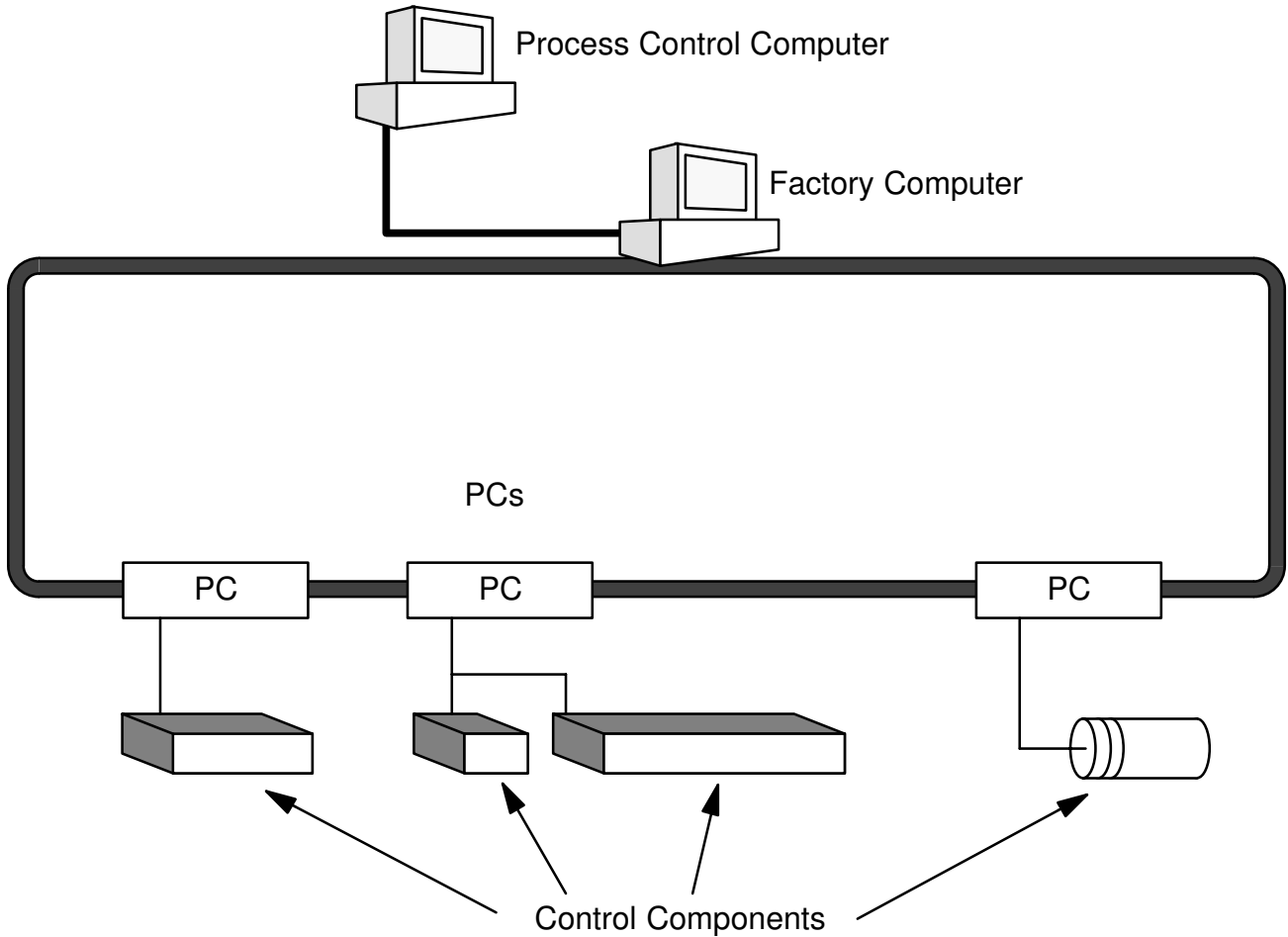

A Control System can involve very large applications where many different models of PC are networked together or it could be an application as small as a single PC controlling a single output device.

A Position Control System

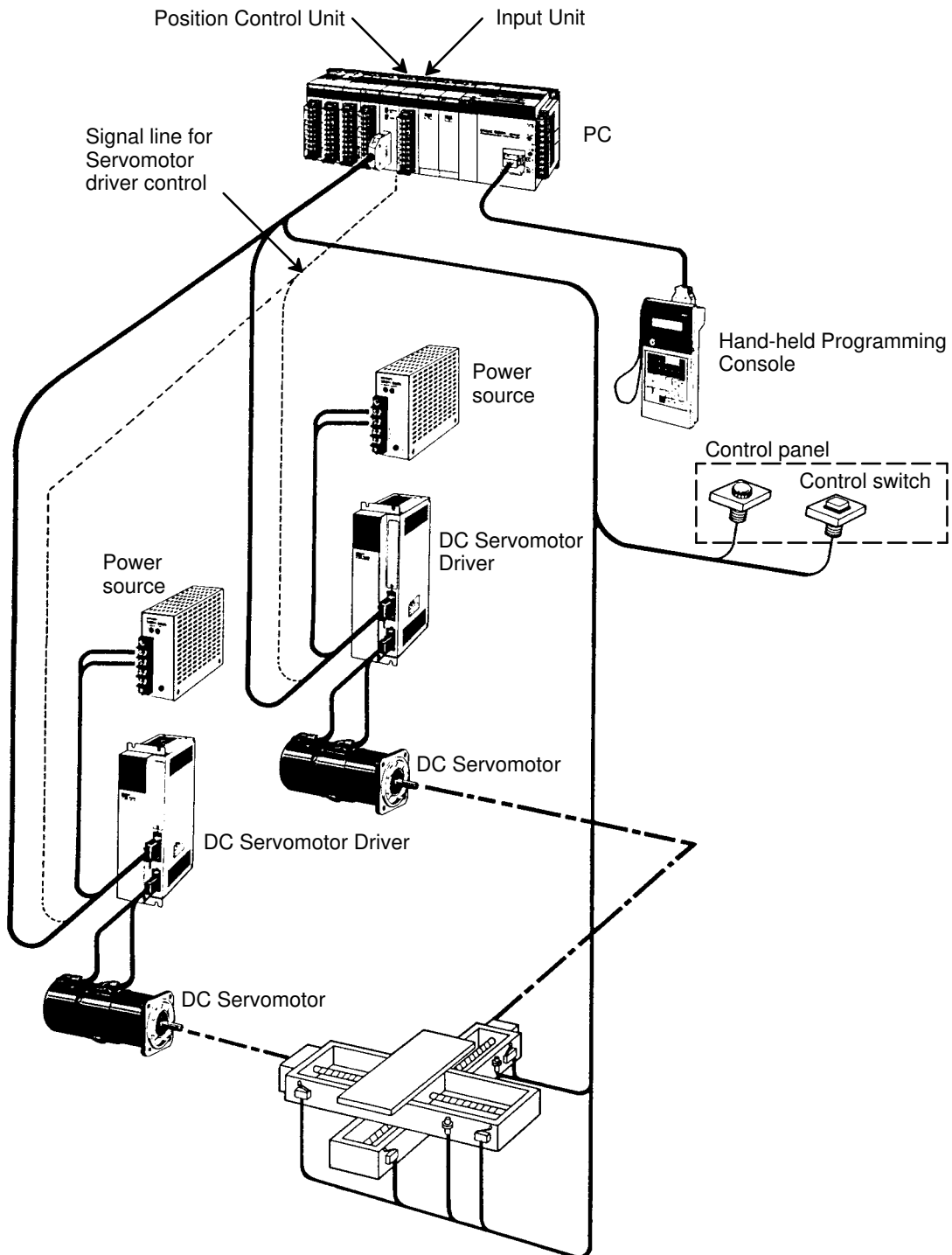

In the typical Control System example shown above, a PC controls the movement of the workpiece bed across two horizontal axes using Limit Switches and Servomotors to monitor and control movement.

1-2 The Role of the PC

The Programmable Controller, or PC, is the part of the Control System that directly controls the manufacturing process. According to the program stored in its memory, the PC accepts data from the input devices connected to it, and uses this data to monitor the controlled system. When the program calls for some action to take place, the PC sends data to the output devices connected to it, to cause that action to take place. The PC may be used to control a simple, repetitive task, or it may be connected to other PCs, or to a host computer in order to integrate the control of a complex process.

1-2-1 Input Devices

PCs can receive input from either automated or manual devices. The PC could receive data from the user via a pushbutton switch, keyboard, or similar device. Automated input could come from a variety of devices: microswitches, timers, encoders, photosensors, and so on. Some devices, like the Limit Switch shown below, turn ON or OFF when the equipment actually makes contact with it. Other devices, like the Photoelectric Switch and Proximity Switch shown below, use other means, such as light or inductance, in order to get information about the equipment being monitored.

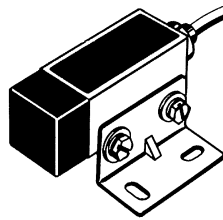

Photoelectric switch

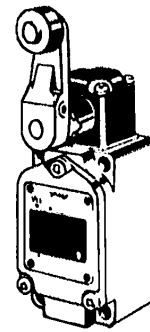

Limit switch

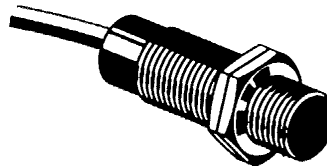

Proximity switch

1-2-2 Output Devices

A PC can output to a myriad of devices for use in automated control. Almost anything that you can think of could be controlled (perhaps indirectly) by a PC. Some of the most common devices are motors, Solenoids, Servomotors, Stepping Motors, valves, switches, indicator lights, buzzers, and alarms. Some of these output devices; such as the motors, Solenoids, Servomotors, Stepping Motors,

and valves; affect the controlled system directly. Others; such as the indicator lights, buzzers, and alarms; provide output to notify personnel.

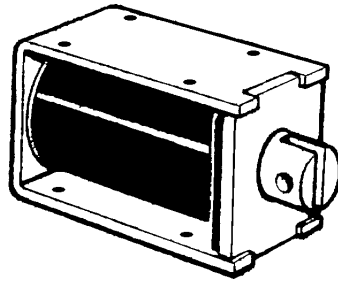

Solenoid

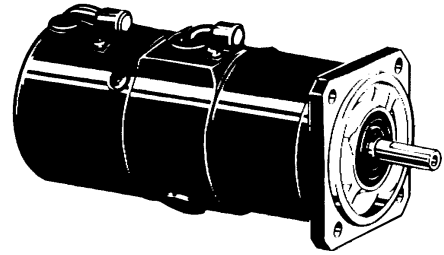

Servomotor

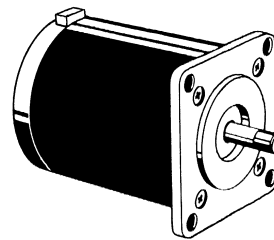

Stepping motor

1-3 How Does a PC Work?

PCs operate by monitoring input signals and providing output signals. When changes are detected in the signals, the PC reacts, through the user-programmed internal logic, to produce output signals. The PC continually scans the program in its memory to achieve this control.

Block Diagram of PC

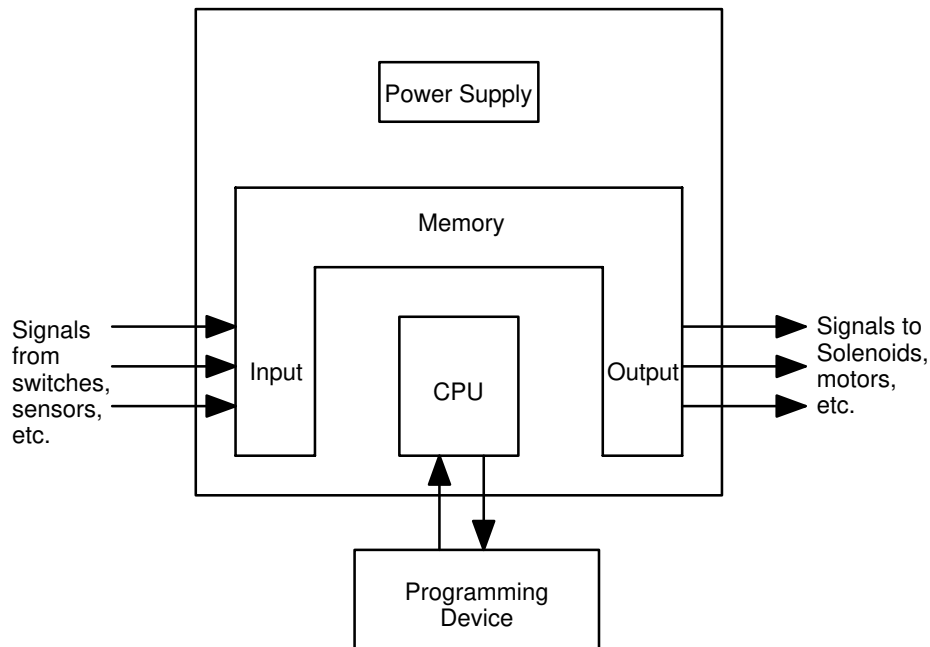

A program for your applications must be designed, and stored in the PC. This program is then executed as part of the cycle of internal operations of the PC.

Cycle

When a PC operates, that is, when it executes its program to control an external system, a series of operations are performed inside the PC. These internal operations can be broadly classified into the following four categories:

- 1, 2, 3...**
1. Common (or overseeing) processes, such as watchdog timer operation and testing the program memory.
 2. Data input and output.
 3. Instruction execution.
 4. Peripheral device servicing.

Cycle Time

The total time required for a PC to perform all these internal operations is called the cycle time. The flowchart and diagram on the following page illustrate these internal operations for a typical PC.

Timing is one of the most important factors in designing a Control System. For accurate operations, it is necessary to have answers to such questions as these:

- How long does it take for the PC to execute all the instructions in its memory?
- How long does it take for the PC to produce a control output in response to a given input signal?

The cycle time of the PC can be automatically calculated and monitored, but it is necessary to have an understanding of the timing relationships within the PC for effective system design and programming.

Flowchart of CPU Operation

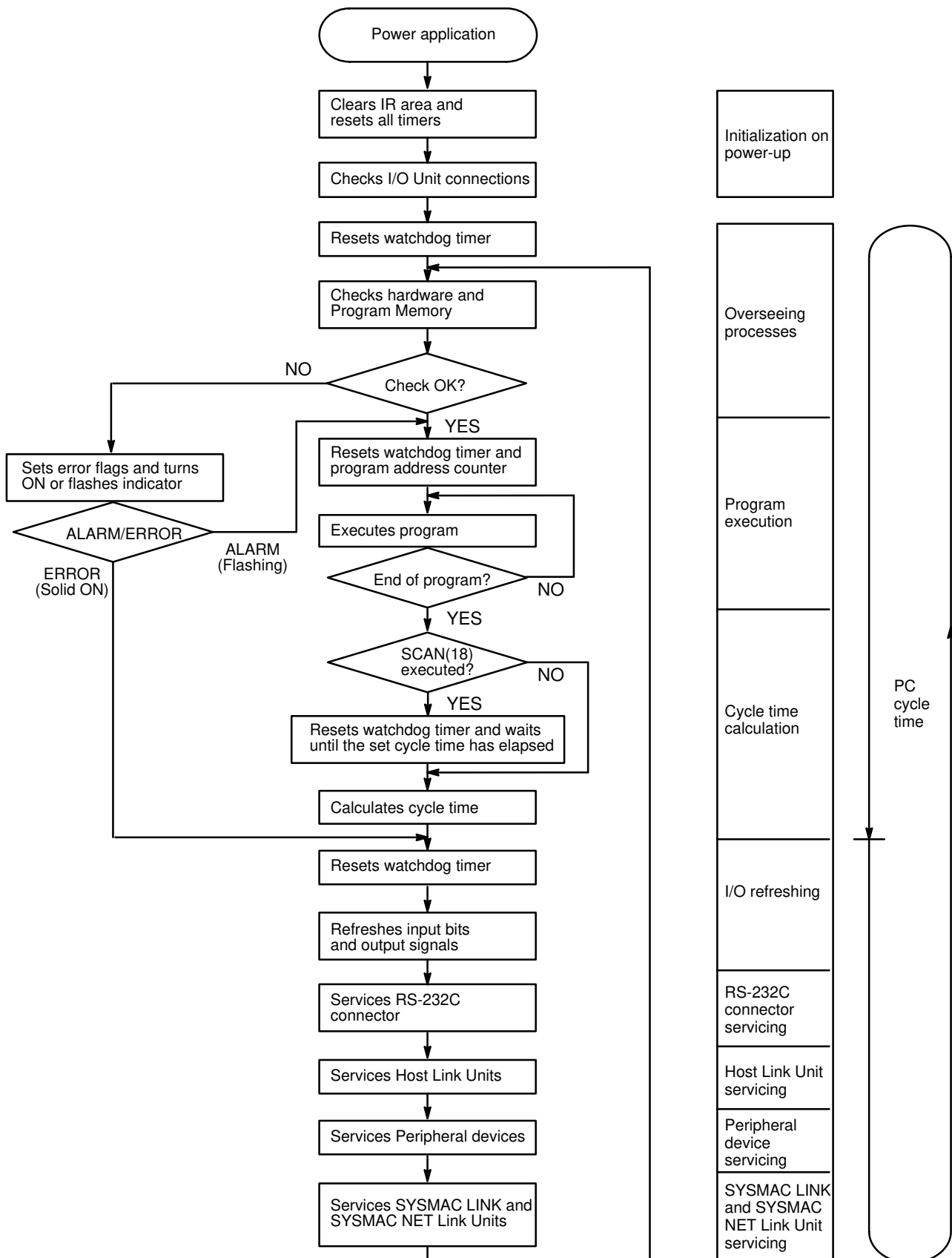

1-4 New C200HS Features

The C200HS CPUs (C200HS-CPU01-E, C200HS-CPU01-EC, C200HS-CPU03-E, C200HS-CPU21-E, C200HS-CPU23-E, C200HS-CPU31-E, and C200HS-CPU33-E) have a number of new features that the C200H CPUs lacked. The new C200HS features are described briefly in this section. The C200HS-CPU01-E, C200HS-CPU01-EC, C200HS-CPU21-E, and C200HS-CPU31-E use an AC power supply and the C200HS-CPU03-E, C200HS-CPU23-E, and C200HS-CPU33-E use DC.

In addition, the C200HS-CPU21-E, C200HS-CPU23-E, C200HS-CPU31-E, and C200HS-CPU33-E CPUs have an RS-232C connector. The C200HS-CPU31-E and C200HS-CPU33-E CPUs support the SYSMAC NET Link Unit and SYSMAC LINK Unit. The C200HS-CPU01-EC CPU and C200HS-CPU03-E CPU with lot number □□Z5 (Dec. 1995) or later conform to EC directives. The C200HS-CPU21-EC CPU conforms to EC directives.

1-4-1 Improved Memory Capabilities

Internal Memory (UM)

The C200HS CPUs come equipped with 16 KW of RAM in the PC itself, so a very large memory capacity is available without purchasing a separate Memory Unit. Furthermore, the program capacity has been increased to 15.2 KW.

Memory Cassettes

Two types of Memory Cassettes are available for storage of data such as the program. The PC can be set to transfer data from the Memory Cassette to UM automatically when the PC is turned on.

Model	Specifications
C200HS-ME16K	16-KW EEPROM
C200HS-MP16K	16-KW EPROM

Note C200H Memory Cassettes cannot be used in the C200HS.

Clock Function

The C200HS CPUs have a built-in clock. It is not necessary to purchase a Memory Unit equipped with a clock, as it was with the C200H-CPU21-E.

Increased SR and IR Areas

The SR area has been increased substantially to provide more work words and words dedicated to new instructions. The SR area now ranges from SR 236 to SR 299. (The SR area ends at SR 255 in C200H CPUs.)

The number of operands and instruction execution time will be increased when SR 256 to SR 299 are used in basic instructions.

I/O and work words previously ranged from 000 to 255. Words 256 to 511 have been added for the C200HS.

Increased DM Area

The Read/Write DM area has been increased substantially, too. It now ranges from DM 0000 to DM 6143, compared to DM 0000 to DM 0999 in C200H CPUs.

The 6000 words from DM 0000 to DM 5999 are available for use in the program. (DM 6000 to DM 6143 are used for the History Log and other functions.)

Fixed DM and Expansion DM Areas

The Fixed DM Area, used to store initializing data for Special I/O Units, has been decreased in size. It now contains the 512 words from DM 6144 to DM 6655, compared to 1000 words (DM 1000 to DM 1999) in C200H CPUs.

In addition, up to 3000 words of UM can be allocated as expansion DM. Expansion DM is allocated in 1000-word units in DM 7000 to DM 9999.

C200H data stored in words DM 1000 to DM 1999 can be used in C200HS PCs by converting these 1000 words to ROM in the C200HS's DM area (DM 7000 to DM 7999) and then automatically transferring them to DM 1000 to DM 1999 when the C200HS is turned on.

1-4-2 Faster Execution Times

Instruction Execution Time Basic instructions in the C200HS are executed in as little as $\frac{1}{2}$ of the time required in the C200H. Other instructions are executed in just $\frac{1}{3}$ to $\frac{1}{8}$ of the time.

END Processing Time The time required for the cycle's overhead processes depend on the system configuration, but these processes are executed in about $\frac{1}{4}$ of the time required in the C200H.

I/O Refreshing Time The I/O refreshing time has been reduced for all units, as shown in the following table.

I/O Unit	Time Required for Refreshing
Standard I/O Units	$\frac{1}{3}$ of the C200H I/O refreshing time
Group-2 High-density I/O Units	$\frac{1}{3}$ of the C200H I/O refreshing time
Special I/O Units	$\frac{4}{5}$ of the C200H I/O refreshing time

1-4-3 Larger Instruction Set

Advanced programming is facilitated by the 225 special instructions available with the C200HS-CPU01-E, C200HS-CPU01-EC, C200HS-CPU03-E, C200HS-CPU21-E, C200HS-CPU21-EC, and C200HS-CPU23-E, or the 229 special instructions available with the C200HS-CPU31-E and C200HS-CPU33-E. In addition, programming has been simplified by the addition of convenient instructions and macro functions. The new instructions and functions are covered in detail in the *C200HS Operation Manual (W235)*.

1-4-4 Expanded Number of I/O Points

Two Expansion I/O Racks can be connected to a CPU Rack to comprise a total of three Racks. This allows for a total of 240 I/O points, for example, when 8-point I/O Units are used, or 480 I/O points when 16-point I/O Units are used.

In addition, a Remote I/O System can provide a maximum of 800 points with Slave Units or 512 points with Optical I/O Units.

1-4-5 Wide Selection of Special I/O Units

C200HS Systems can be configured in a variety of ways, using High-density I/O Units, High-speed Counters, Position Control Units, Analog I/O Units, Temperature Sensor Units, ASCII Units, Voice Units, ID Sensor Units, Fuzzy Logic Units, Cam Positioner Units, and so on.

1-4-6 Improved Interrupt Functions

Scheduled Interrupts The C200HS's scheduled interrupt function has been improved so that the interrupt interval can be set in 1 ms units rather than the 10 ms units in the C200H. When the interrupt mode is set to C200HS mode, the interrupt response time is only 1 ms max. (excluding the input ON/OFF delays). When a Communications Unit is used with the C200HS-CPU31-E/CPU33-E CPU, the interrupt response time is 10 ms max.

Input Interrupts Up to 8 interrupt subroutines can be executed by inputs to a C200HS-INT01 Interrupt Input Unit mounted to the C200HS. When the interrupt mode is set to C200HS mode, the interrupt response time is only 1 ms max. (excluding the input ON/OFF delays). When a Communications Unit is used with the C200HS-CPU31-E/CPU33-E CPU, the interrupt response time is 10 ms max.

1-4-7 SYSMAC NET Link and SYSMAC LINK Capabilities

The SYSMAC NET Link and SYSMAC LINK Systems are high-speed FA networks which can be used with the C200HS-CPU31-E and C200HS-CPU33-E CPUs and the following Units:

SYSMAC NET Link Unit:	C200HS-SNT32
SYSMAC LINK Units:	C200HW-SLK13/SLK14 (optical fiber cable) C200HW-SLK23/SLK24 (coaxial cable)

Data can be exchanged with the PCs in a SYSMAC NET Link or SYSMAC LINK System using the SEND and RECV instructions.

1-4-8 Built-in RS-232C Connector

Host link communications are possible using the RS-232C connector built into the C200HS-CPU21-E/CPU21-EC/CPU23-E/CPU31-E/CPU33-E CPU. By using the TXD and RXD instructions, RS-232C communications is possible without using time-consuming procedures. A 1-to-1 link using the LR Area or an NT link with the Programmable Terminal (PT) allows high-speed communications.

1-4-9 More Flexible PC Settings

With its default settings, the C200HS can be used like a C200H PC, but the C200HS's new settings provide more flexibility and allow it to be adjusted to fit particular applications. These new settings are described below.

DIP Switch Settings

The 6 pins on the C200HS's DIP switch are used to write-protect part of UM, set the CPU to automatically transfer Memory Card data to UM, and other functions.

UM Area Allocation

Portions of the UM area can be allocated for use as the Expansion DM Area and I/O Comment Area. (Most of the UM area is used to store the ladder program.)

PC Setup

DM 6600 to DM 6655 is set aside for PC Setup data. The PC Setup determines many operating parameters, including the startup mode and initial Special I/O Unit area.

1-4-10 Debugging and Maintenance

New functions such as data trace and differential monitor have been added, making it easier to check status changes. These and other new functions are covered in detail in the *C200HS Operation Manual (W235)*.

1-4-11 Peripheral Devices

Peripheral Device Connection

With the C200H, Peripheral Devices had to be connected through a Peripheral Interface Unit or Host Link Unit, but with the C200HS Peripheral Devices can be connected to the PC through a CQM1-CIF02 Connecting Cable.

I/O Comments Stored in PC

By allocating a part of UM as the I/O Comment area, it is no longer necessary to read I/O Comments from a Peripheral Device's floppy disk. If the Peripheral Device is connected to the C200HS online, the ladder diagram can be viewed with I/O comments.

Online Editing

A "CYCLE TIME OVER" error will no longer be generated when the program in the PC itself is being edited online.

1-5 Comparisons Between C200HS and C200H

The following table outlines the main upgrades that have been made, and the differences in functions and performance between the C200HS and the C200H.

Function	Model	
	C200HS	C200H
Memory		
Built-in UM capacity	RAM: 16K words (Program capacity: 15.2K words)	None (Memory Unit used.)
Optional memory	Memory Cassette (backup, storage)	Memory Unit (for loading, storing UM)
EEPROM	C200HS-ME 16K (16K words)	C200H-ME431/2 (4K words) C200H-ME831/2 (8K words)
EPROM	C200HS-MP 16K (16K words)	C200H-MP831 (8K words)
RAM	---	C200H-MR431/2/3 (4K words) C200H-MR831/2/3 (8K words)
I/O memory		
IR memory	3,296 bits (03000 to 23515) 3,392 bits (30000 to 51115)	3,296 bits (03000 to 23515)
SR memory	312 bits (23600 to 25507) 704 bits (25600 to 29915)	312 bits (23600 to 25507)
Data Memory		
Normal DM	6,144 words (DM 0000 to DM 6143)	1,000 words (DM 0000 to DM 0999)
Fixed DM	512 words (DM 6144 to DM 6655)	1,000 words (DM 1000 to DM 1999)
Expansion DM	0 to 3,000 words (DM 7000 to DM 9999)	---
Clock function	Standard for all models.	Standard for CPU11-E/31-E. Included in Memory Unit for C200HS-CPU21-E/22-E/23-E.
Execution time		
Instruction execution time		
Basic instructions	0.375 to 1.125 μ s	0.75 to 2.25 μ s
Special instructions	Approx. 1/4 that of the C200H.	34 to 724 μ s
Common processing time (END processing time)	0.7 ms	2.8 ms
I/O refresh time		
Basic I/O	Approx. 1/3 that of the C200H.	0.04 to 0.07 ms/8 bits
High-density I/O (Group 2)	Approx. 1/3 that of the C200H.	0.34 to 0.86 ms/Unit
Special I/O	Approx. 4/5 that of the C200H.	0.8 to 6.5 ms/Unit
Instructions		
Number of instructions	225 (229 for the CPU31-E/CPU33-E)	168 (172 for the CPU31-E)
Basic instructions	14 (SET/RSET added)	12
Special instructions	211 (215 for the CPU31-E/CPU33-E)	156 (160 for the CPU31-E)
Setting functions	UM area arrangement PC operation setting switch Special instruction settings PC Setup	---

Function	Model	
	C200HS	C200H
Interrupt function		
Scheduled interrupts		
Interrupt period	10 ms x SV or 1 ms x SV	10 ms x SV
Interrupt response time	10 ms max. (C200H common mode, Communications Unit connected) 1 ms (C200HS mode, Communications Unit not connected)	10 ms max.
Input interrupts	8 points max.	
Interrupt Input Unit	C200HS-INT01 (8 points)	No interrupt input function
Backplane	C200H-BC□□1-V2 (corresponding to Interrupt Input Unit)	C200H-BC□□1-V1 (Interrupt Input Unit not possible.)
Interrupt response time	1 ms max. (10 ms max. when Communications Unit connected)	
Debugging and maintenance	Forced set/reset Data trace Differential monitor	Forced set/reset
Programming Console operations	Decimal display of binary data Continuation of display when modes are switched Terminal mode and expansion terminal mode	Terminal mode
Peripheral Devices		
Connection method	Direct connection to C200HS.	Connection via Peripheral Interface Unit or Host Link Unit.
Cable for personal computer	CQM1-CIF02	
SYSMAC Support Software (SSS)	C500-ZL3AT1-E	C500-ZL3AT1-E
I/O comments	Can be stored in C200HS	
Online editing	Cycle time over non-detection setting possible.	
Communications Units	For C200HS-CPU31-E/CPU33-E	
SYSMAC NET Link	C200HS-SNT32	C200H-SNT31
SYSMAC LINK	C200HW-SLK13/SLK14 (Optical) C200HW-SLK23/SLK24 (Coaxial)	C200H-SLK11 C200H-SLK21-V1
Built-in Host Link	RS-232C connector built into the C200HS-CPU21-E/CPU21-EC/ CPU23-E/CPU31-E/CPU33-E	---
1-to-1 link	LR Area is shared by connecting RS-232C connectors.	
NT link	High-speed communications with Programmable Terminal (PT) via RS-232C connector.	
Host Link Units		
Added function	Transmission possible by means of TXD instruction.	
Optical cable	C200H-LK101-PV1	C200H-LK101-P
RS-232C	C200H-LK201-V1	C200H-LK201
RS-422	C200H-LK202-V1	C200H-LK202

1-6 Compatibility of C200HS and C200H Devices

Completely compatible: C200H devices can be used with the C200HS as is.

Replacement Units: These Units were developed for the C200HS and can be used for both the C200H and the C200HS.

C200HS only: These devices can only be used with the C200HS.

Classification	Type of Unit	Completely compatible	Replacement Units	C200HS only	Remarks
CPU Rack	CPU			Yes	C200HS-CPU01-E/01-EC /03-E/21-E/21-EC/23-E/ 31-E/33-E
	Backplane		Yes		C200H-BC031-V2/051-V2 /081-V2/101-V2 (Existing Backplanes can be used if Interrupt Input Units are not used.)
	Memory Cassette			Yes	C200HS-ME16K/MP16K
Expansion I/O Rack		Yes			Configured based on Backplane and I/O Power Supply Unit.
I/O Connecting Cable		Yes			One cable is required to connect one Expansion I/O Rack.
I/O Unit	8/12/16-pt. I/O Units	Yes			
	Standard B7A Interface Units	Yes			16 pts.
	Group-2 High-density I/O Unit and Group-2 B7A Interface Units	Yes			32 pts. or 64 pts.
	Special I/O Unit	Yes			High-speed Counters, Position Control Units, High-density I/O Units, Analog I/O Units, Temperature Sensor Units, ASCII Units, etc.
	Interrupt Unit			Yes	When mounting an Interrupt Input Unit, use the C200H-BC□□1-V2.
Remote I/O (Optical)	Master Unit	Yes			C200H-RM001-PV1
	Slave Unit	Yes			C200H-RT001-P/002-P
Remote I/O (Wired)	Master Unit	Yes			C200H-RM201
	Slave Unit	Yes			C200H-RT201/201-C/202
Link	Host Link Unit		Yes		C200H-LK101-PV1 C200H-LK201-V1 C200H-LK202-V1
	PC Link Unit	Yes			C200H-LK401
	SYSMAC LINK		Yes		C200HW-SLK13/SLK14 C200HW-SLK23/SLK24
	SYSMAC NET Link		Yes		C200HS-SNT32
Peripheral Device	Programming Console	Yes			C200H-PRO27-E CQM1-PRO01-E
	SSS	Yes			C500-ZL3AT1-E