



Chipsmall Limited consists of a professional team with an average of over 10 year of expertise in the distribution of electronic components. Based in Hongkong, we have already established firm and mutual-benefit business relationships with customers from,Europe,America and south Asia,supplying obsolete and hard-to-find components to meet their specific needs.

With the principle of “Quality Parts,Customers Priority,Honest Operation,and Considerate Service”,our business mainly focus on the distribution of electronic components. Line cards we deal with include Microchip,ALPS,ROHM,Xilinx,Pulse,ON,Everlight and Freescale. Main products comprise IC,Modules,Potentiometer,IC Socket,Relay,Connector.Our parts cover such applications as commercial,industrial, and automotives areas.

We are looking forward to setting up business relationship with you and hope to provide you with the best service and solution. Let us make a better world for our industry!



Contact us

Tel: +86-755-8981 8866 Fax: +86-755-8427 6832

Email & Skype: info@chipsmall.com Web: www.chipsmall.com

Address: A1208, Overseas Decoration Building, #122 Zhenhua RD., Futian, Shenzhen, China



SYSMAC

C200HW-COM01

C200HW-COM02-V1 to C200HW-COM06-EV1

Communications Boards

OPERATION MANUAL

OMRON

**C200HW-COM01
C200HW-COM02-V1 to C200HW-COM06-EV1
Communications Boards**

Operation Manual

Revised November 2003

Notice:

OMRON products are manufactured for use according to proper procedures by a qualified operator and only for the purposes described in this manual.

The following conventions are used to indicate and classify precautions in this manual. Always heed the information provided with them. Failure to heed precautions can result in injury to people or damage to property.

 **DANGER** Indicates an imminently hazardous situation which, if not avoided, will result in death or serious injury.

 **WARNING** Indicates a potentially hazardous situation which, if not avoided, could result in death or serious injury.

 **Caution** Indicates a potentially hazardous situation which, if not avoided, may result in minor or moderate injury, or property damage.

OMRON Product References

All OMRON products are capitalized in this manual. The word “Unit” is also capitalized when it refers to an OMRON product, regardless of whether or not it appears in the proper name of the product.

The abbreviation “Ch,” which appears in some displays and on some OMRON products, often means “word” and is abbreviated “Wd” in documentation in this sense.

The abbreviation “PC” means Programmable Controller and is not used as an abbreviation for anything else.

Visual Aids

The following headings appear in the left column of the manual to help you locate different types of information.

Note Indicates information of particular interest for efficient and convenient operation of the product.

1, 2, 3... 1. Indicates lists of one sort or another, such as procedures, checklists, etc.

© OMRON, 1996

All rights reserved. No part of this publication may be reproduced, stored in a retrieval system, or transmitted, in any form, or by any means, mechanical, electronic, photocopying, recording, or otherwise, without the prior written permission of OMRON.

No patent liability is assumed with respect to the use of the information contained herein. Moreover, because OMRON is constantly striving to improve its high-quality products, the information contained in this manual is subject to change without notice. Every precaution has been taken in the preparation of this manual. Nevertheless, OMRON assumes no responsibility for errors or omissions. Neither is any liability assumed for damages resulting from the use of the information contained in this publication.

TABLE OF CONTENTS

PRECAUTIONS	xi
1 Intended Audience	xii
2 General Precautions	xii
3 Safety Precautions	xii
4 Operating Environment Precautions	xiii
5 Application Precautions	xiii
SECTION 1	
Handling Communications Boards	1
1-1 Functions	2
1-2 Hardware Connections	14
1-3 PC Setup	16
1-4 SR Words and Bits	19
SECTION 2	
Protocol Macros	23
2-1 Outline	24
2-2 Protocol Support Software	34
2-3 Using the System Protocol Macros	38
2-4 Troubleshooting	55
Appendices: System Protocols	
A E5□K Digital Controller Read Protocol	59
B E5□K Digital Controller Write Protocol	77
C E5ZE Temperature Controller Read Protocol	93
D E5ZE Temperature Controller Write Protocol	115
E E5□J Temperature Controller Protocol	135
F ES100□ Digital Controller Protocol	149
G K3T□ Intelligent Signal Processor Protocol	191
H V500/V520 Bar Code Reader Protocol	213
I 3Z4L Laser Micrometer Protocol	225
J Visual Inspection System Protocol	257
K V600/V620 ID Controller Protocol	275
L Hayes Modem AT Command Protocol	311
Index	319
Revision History	325

About this Manual:

This manual describes the installation and operation of the C200HW-COM01, C200HW-COM02-V1, C200HW-COM03-V1, C200HW-COM04-EV1, C200HW-COM05-EV1, and C200HW-COM06-EV1 Communications Boards for the C200HX/C200HG/C200HE Programmable Controllers and includes the sections described below. The manual is also written so that it can be used for the previous versions of these Communications Boards even though some of the protocol macro functionality is not supported.

When using the Communications Boards, information in the following manuals will also be required. (Catalog number suffixes have been omitted. Please be sure you have the most recent version of your manual for your area. Contact your OMRON representative for more information.)

Manual	Content	Cat. No.
C200HW-ZW3PC1 Protocol Support Software Operation Manual	Information on using the Software to create protocol macros and information on the system protocol macros.	W305
SYSMAC WS01-PSTF1-E Protocol Support Tool SYSMAC-PST Operation Manual	Information on SYSMAC-PST, a Windows-95-based software package that supports the protocol macro functionality of models C200HW-COM04(-EV1) to C200HW-COM06(-EV1).	W319
SYSMAC WS02-PSTC1-E CX-Protocol Operation Manual	Information on CX-Protocol, a Windows-95/98-based software package that supports the protocol macro functionality of models C200HW-COM04(-EV1) to C200HW-COM06(-EV1), CS1W-SCB21/41, and CS1W-SCU21.	W344
C200HX/C200HG/C200HE (-E/-ZE) Operation Manual	Information on programming and operating the PC.	W303
C200HX/C200HG/C200HE Installation Guide	Information required to install and maintain PC hardware.	W302

Please read this manual and the above related manuals carefully and be sure you understand the information provided before attempting to install and operate a Communications Board. **Be sure to read the precautions in the following section and understand the information contained before attempting to set up or operate a PC system containing a Communications Board.**

Section 1 Handling the Communications Board provides an outline of the functions of the Communications Boards, the installation method, the system configuration, and the system setup.

Section 2 Protocol Macro Function describes the protocol macro function supported by Communications Boards, and how to use the system protocol macros provided with the Protocol Support Software. Troubleshooting is also described in this section.

The **Appendices** provide configuration information for various OMRON products and Hayes Modems. These are as follows:

 WARNING Failure to read and understand the information provided in this manual may result in personal injury or death, damage to the product, or product failure. Please read each section in its entirety and be sure you understand the information provided in the section and related sections before attempting any of the procedures or operations given.
--

About this Manual

Appendix Contents

- A E5□K Digital Controller Reads
- B E5□K Digital Controller Writes
- C E5ZE Temperature Controller Reads
- D E5ZE Temperature Controller Writes
- E E5□J Temperature Controllers
- F ES100□ Digital Controllers

Appendix Contents

- G K3T□ Intelligent Signal Processors
- H V500/V520 Bar Code Readers
- I 3Z4L Laser Micrometer
- J F200/F300/F350 Visual Inspection Systems
- K V600/620 ID Controllers
- L Hayes Modem AT Commands

Refer to the following manuals when using the built-in protocols.

Device/Manual name	Catalog No.
E5CK Digital Controller User's Manual	H78
E5ZE Multipoint Temperature Controller Operation Manual	H76
E5ZE Multipoint Temperature Controller COMMUNICATIONS MANUAL	H77
E5□J Temperature Controller Operation Manual	Z103
E5□J Electronic Temperature Controller Manual	Z103
ES100P Digital Controller User's Manual	H069
ES100X DIGITAL CONTROLLER User's Manual	H070
ES100 COMMUNICATIONS GUIDE User's Manual	H072
K3TC Intelligent Signal Processor Operation Manual	Z117
K3tC/K3TH/K3TR/K3TX Communication Output-type Intelligent Signal Processor Operation Manual	Z81
F200-C12E Specifications/Instruction Manual	Z110
F300 Visual Inspection System Menu Mode Operation Manual	Z91
F350-U001E Character Inspection Software 1 Operation Manual	Z105
F350-U003E Position Software 1 Operation Manual	Z107
V600/V620 FA ID SYSTEM Operation Manual	Z83

PRECAUTIONS

This section provides general precautions for using the Communications Boards.

The information contained in this section is important for the safe and reliable application of the Communications Boards and the PC in general. You must read this section and understand the information contained before attempting to set up or operate a PC system containing a Communications Board.

1 Intended Audience	xii
2 General Precautions	xii
3 Safety Precautions	xii
4 Operating Environment Precautions	xiii
5 Application Precautions	xiii

1 Intended Audience

This manual is intended for the following personnel, who must also have knowledge of electrical systems (an electrical engineer or the equivalent).

- Personnel in charge of installing FA systems.
- Personnel in charge of designing FA systems.
- Personnel in charge of managing FA systems and facilities.

2 General Precautions

The user must operate the product according to the performance specifications described in the operation manuals.





Before using the product under conditions which are not described in the manual or applying the product to nuclear control systems, railroad systems, aviation systems, vehicles, combustion systems, medical equipment, amusement machines, safety equipment, and other systems, machines, and equipment that may have a serious influence on lives and property if used improperly, consult your OMRON representative.

Make sure that the ratings and performance characteristics of the product are sufficient for the systems, machines, and equipment, and be sure to provide the systems, machines, and equipment with double safety mechanisms.

This manual provides information for programming and operating OMRON PCs. Be sure to read this manual before attempting to use the software and keep this manual close at hand for reference during operation.



-  **WARNING** It is extremely important that a Communications Board and all related units be used for the specified purpose and under the specified conditions, especially in applications that can directly or indirectly affect human life. You must consult with your OMRON representative before applying a Communication Board to the above mentioned applications.

3 Safety Precautions

-  **WARNING** Do not attempt to take any Unit apart while the power is being supplied. Doing so may result in electric shock.
-  **WARNING** Do not touch any of the terminals or terminal blocks while the power is being supplied. Doing so may result in electric shock.
-  **WARNING** Do not attempt to disassemble, repair, or modify any Units. Any attempt to do so may result in malfunction, fire, or electric shock.
-  **WARNING** Never open the back cover of devices containing monitors, such as CRTs. High-voltage parts are contained inside. Opening the back cover may result in electric shock.
-  **Caution** When using the large-capacity C200HW-PA209R Power Supply Unit, be sure to use CPU Backplanes and Expansion I/O Backplanes with “-V1” at the end of the model number. If 8-slot or 10-slot Backplanes without “-V1” are used, deterioration and pattern disconnection on the Backplane may occur, leading to incorrect operation.

-  **Caution** When using the large-capacity C200HW-PA209R Power Supply Unit, the temperature of the Unit will increase during power supply and immediately after power supply is turned OFF. Do not touch the Unit at these times. Doing so may result in injury.

4 Operating Environment Precautions

-  **Caution** Do not operate the control system in the following locations:
- Locations subject to direct sunlight.
 - Locations subject to temperatures or humidity outside the range specified in the specifications.
 - Locations subject to condensation as the result of severe changes in temperature.
 - Locations subject to corrosive or flammable gases.
 - Locations subject to dust (especially iron dust) or salts.
 - Locations subject to exposure to water, oil, or chemicals.
 - Locations subject to shock or vibration.
-  **Caution** Take appropriate and sufficient countermeasures when installing systems in the following locations:
- Locations subject to static electricity or other forms of noise.
 - Locations subject to strong electromagnetic fields.
 - Locations subject to possible exposure to radioactivity.
 - Locations close to power supplies.
-  **Caution** The operating environment of the PC system can have a large effect on the longevity and reliability of the system. Improper operating environments can lead to malfunction, failure, and other unforeseeable problems with the PC system. Be sure that the operating environment is within the specified conditions at installation and remains within the specified conditions during the life of the system.

5 Application Precautions

Observe the following precautions when using the PC system.

-  **WARNING** Always heed these precautions. Failure to abide by the following precautions could lead to serious or possibly fatal injury.
- Always ground the system to 100 Ω or less when installing the Units. Not connecting to a ground of 100 Ω or less may result in electric shock.
 - Always turn OFF the power supply to the PC before attempting any of the following. Not turning OFF the power supply may result in malfunction or electric shock.
 - Mounting or dismounting I/O Units, CPU Units, Memory Units, or any other Units.
 - Assembling the Units.
 - Setting DIP switches or rotary switches.
 - Connecting cables or wiring the system.
 - Connecting or disconnecting the connectors.

 **Caution** Failure to abide by the following precautions could lead to faulty operation of the PC or the system, or could damage the PC or PC Units. Always heed these precautions.

- Fail-safe measures must be taken by the customer to ensure safety in the event of incorrect, missing, or abnormal signals caused by broken signal lines, momentary power interruptions, or other causes.
- Interlock circuits, limit circuits, and similar safety measures in external circuits (i.e., not in the Programmable Controller) must be provided by the customer.
- Always use the power supply voltages specified in this manual. An incorrect voltage may result in malfunction or burning.
- Take appropriate measures to ensure that the specified power with the rated voltage and frequency is supplied. Be particularly careful in places where the power supply is unstable. An incorrect power supply may result in malfunction.
- Install external breakers and take other safety measures against short-circuiting in external wiring. Insufficient safety measures against short-circuiting may result in burning.
- Do not apply voltages to the Input Units in excess of the rated input voltage. Excess voltages may result in burning.
- Do not apply voltages or connect loads to the Output Units in excess of the maximum switching capacity. Excess voltage or loads may result in burning.
- Disconnect the functional ground terminal when performing withstand voltage tests. Not disconnecting the functional ground terminal may result in burning.
- Be sure that all the mounting screws, terminal screws, and cable connector screws are tightened to the torque specified in this manual. Incorrect tightening torque may result in malfunction.
- Check the user program for proper execution before actually running it on the Unit. Not checking the program may result in an unexpected operation.
- Do not pull on the cables or bend the cables beyond their natural limit. Doing either of these may break the cables.
- Do not place objects on top of the cables or other wiring lines. Doing so may break the cables.
- When replacing parts, be sure to confirm that the rating of a new part is correct. Not doing so may result in malfunction or burning.
- Before touching a Unit, be sure to first touch a grounded metallic object in order to discharge any static built-up. Not doing so may result in malfunction or damage.

SECTION 1

Handling Communications Boards

This section provides an outline of the functions of the Communications Boards, the installation method, the system configuration, and the system setup.

1-1	Functions	2
1-1-1	Features	2
1-1-2	Protocols	5
1-1-3	Communications Board Models	6
1-1-4	DIP Switch Settings	8
1-1-5	Applicable CPU Units	9
1-1-6	Installation	10
1-1-7	Indicators	11
1-1-8	Communications Board Specifications	12
1-1-9	Basic Specifications	12
1-1-10	Communications Specifications	12
1-1-11	Communications Modes and Transmission Paths	13
1-2	Hardware Connections	14
1-3	PC Setup	16
1-4	SR Words and Bits	19

1-1 Functions

The Communications Boards are optional boards that can be installed in the option slot of various C200HX/C200HG/C200HE CPU Units (CPU□5-E, CPU□4-E, CPU□3-E, CPU□2-E).

1-1-1 Features

The following features are provided by mounting a Communications Board in the option slot of a CPU Unit.

Connection to Communications Units via CPU Bus

The CPU Unit can be connected to Controller Link, SYSMAC LINK, SYSMAC NET or other Communications Units via a Bus Connection Unit.

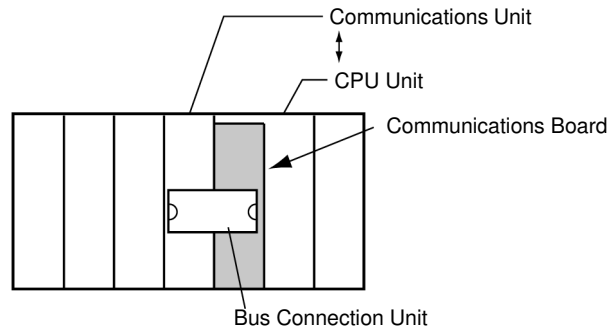

Expanded Communications

Host Link Communications: 1:N

The PC can be controlled from a host computer (personal computer or Programmable Terminal (PT)) to read/write I/O memory, control the operating mode of the PC, etc. The PC can also use the TXD instruction to send specified words in I/O memory to a host.

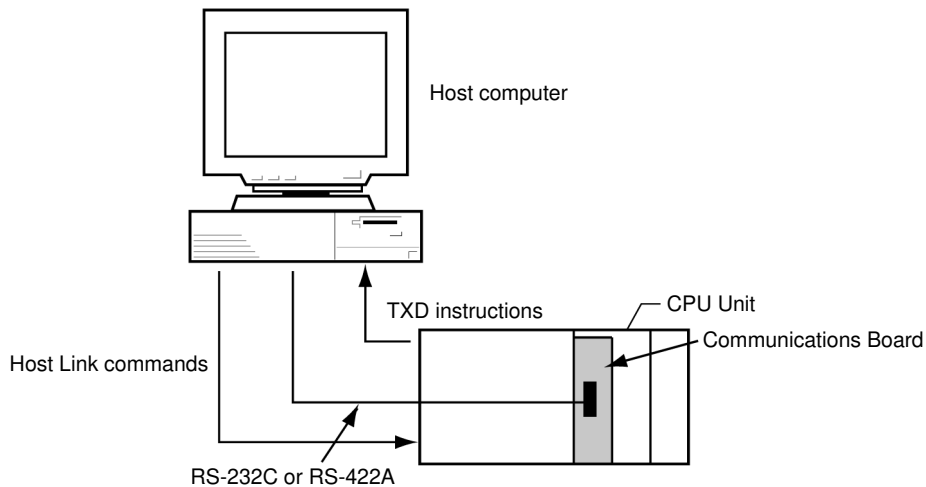

Note The RP Host Link command can be used for C200HX//HE/HE-CPU□□-ZE CPU Units only when a V1 Communications Board is mounted.

Non-procedure Communications

Simple (no-protocol) data transfers are possible using the communications port I/O instructions (TXD and RXD) to input data from a bar code reader, output data

to a printer, etc. The usage of start and end codes can be specified and RTS and CTS signals can be controlled.

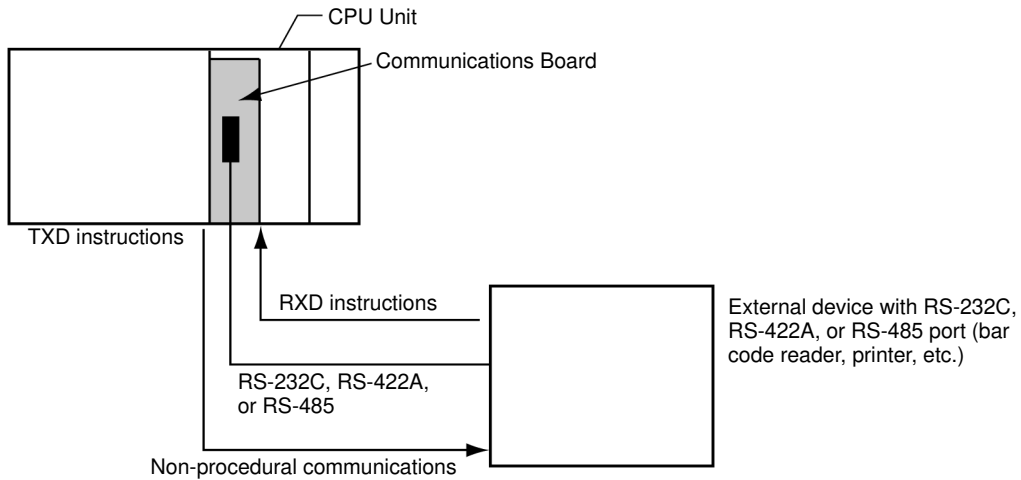

1:1 Links

Common data areas can be created in the LR Area without using PC Link Units by connecting two PCs 1:1 via the RS-232C port.

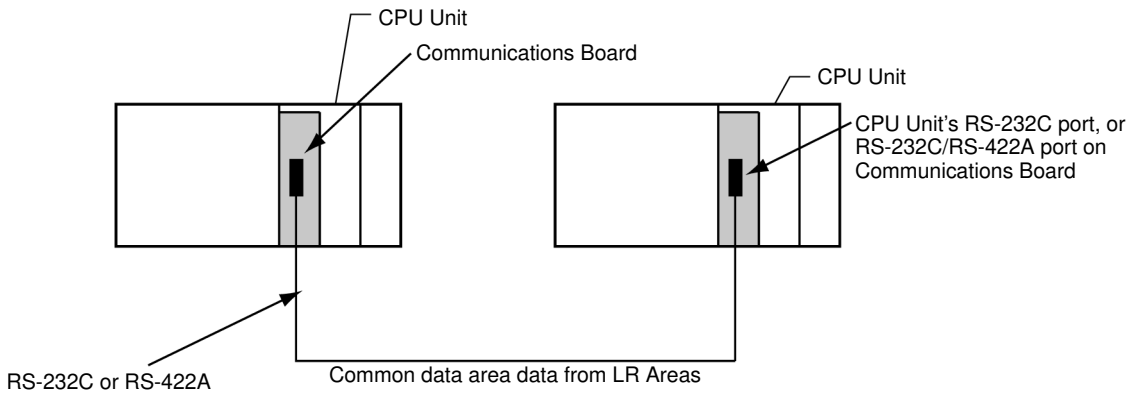

NT Links: 1:1 or 1:N

A PC can be connected to one or more PTs (Programmable Terminals) via an RS-232C port to enable data transfer via NT Link commands.

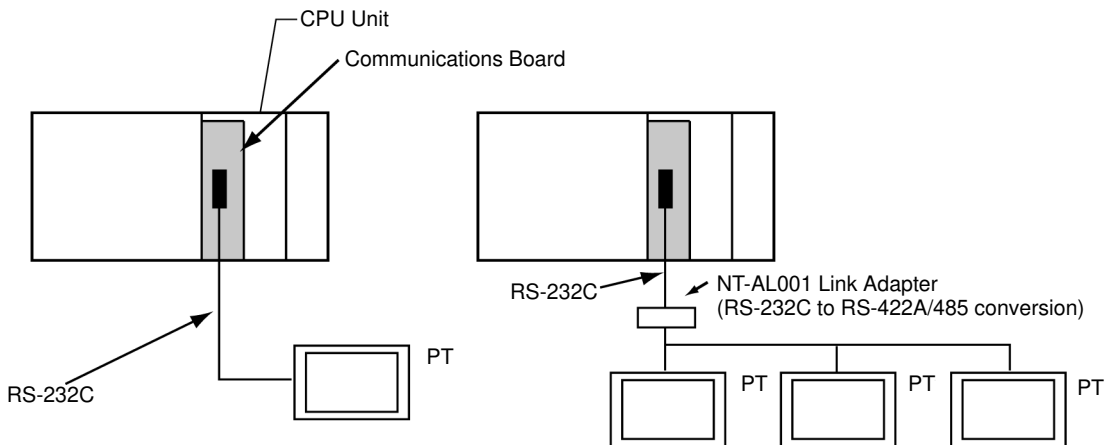

Protocol Macros

Data transfer procedures called protocols can be easily created using the Protocol Support Software (sold separately). Procedures can be designed to match

the communications specifications of the external devices that are being communicated with (half duplex or start-stop sync). The protocols that are created are loaded to the Communications Board to enable data transfer with the external devices simply by executing the PMCR instruction from the PC. There are also many system protocols provided with the Communications Boards and Protocol Support Software to enable communications with OMRON Temperature Controllers, Panel Meters, Intelligent Signal Processors, Bar Code Readers, Modems, etc. The system protocols can also be modified for other applications according to user needs.

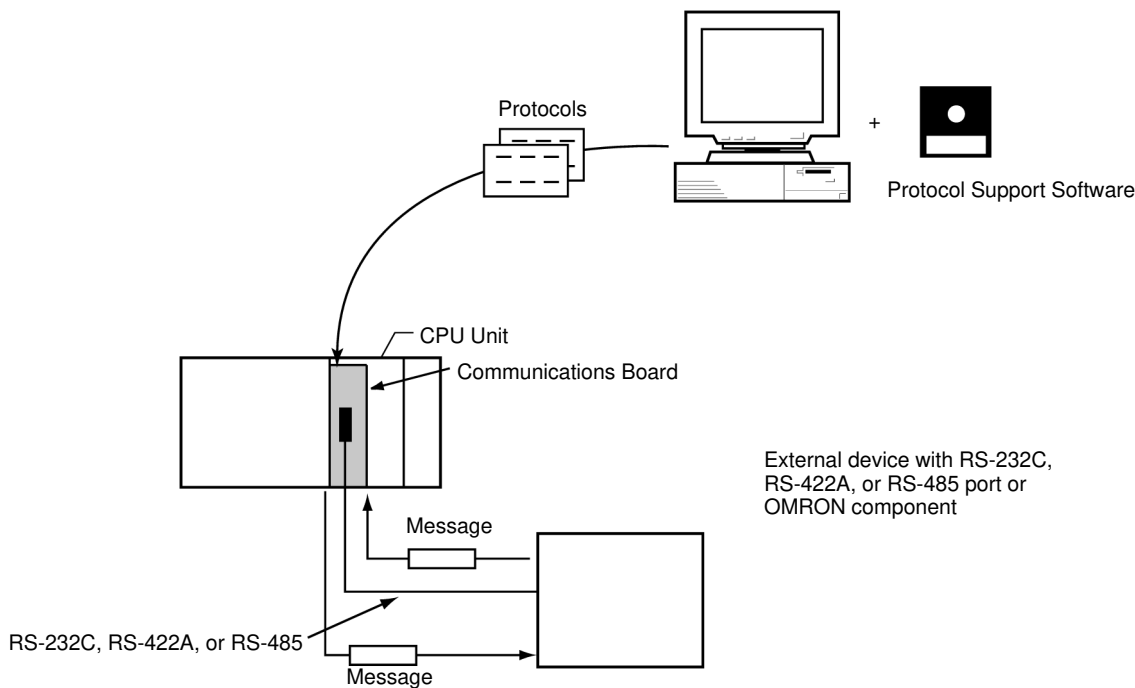

Note The following protocol macro functionality has been added to the V1 Communications Boards. The following are possible only for the C200HW-COM□□-EV1 Communications Boards.

- SUM2 (SUM of two's complement) and CRC-16 can be used for error checking.
- The Repeat Counter N Present Value, a Sequence End Flag, and a Sequence Abort Flag are provided in the SR area.
- The check code can be placed after the terminator in the message sequence. (Supported by SYSMAC-PST and CX-Protocol.)
- The upper and lower bytes of the error check code can be swapped. (Supported by SYSMAC-PST and CX-Protocol.)

1-1-2 Protocols

The Communications Board supports the following protocols.

Protocol	Device	Connection configuration	Outline	Communications instruction
Host Link	PC ← → Personal computer or PT	1 to 1 or 1 to N	<p>Communications procedure between a host personal computer and PCs.</p> <p>Can monitor operation status of PC or bit status from a personal computer.</p> <p>Can transfer data stored in the IOM area of PC to a host personal computer using the TXD instruction.</p>	Host Link commands or TXD instruction
Non-procedure	PC ← → Personal computer or Component	1 to 1	<p>Can achieve simple communications sequences using communications port I/O instructions (TXD, RXD), including data input from a bar code reader and data output to a printer.</p> <p>Can control RS, CS, ER, and DR control signals using the instructions.</p>	TXD and RXD instructions
1 to 1 link	PC ← → PC	1 to 1	<p>Connects two PCs on a one to one basis. The PCs share LR Area data.</p>	---
NT Link	PC ← → PT	1 to 1 or 1 to N	<p>Achieves data communications by connecting PCs and PTs on a one to one basis or one to N basis.</p>	---
Protocol macros	PC ← → Various components	1 to 1 or 1 to N	<p>Can transmit messages by defining a specific communications sequences.</p> <p>Can register up to 1,000 communications sequences.</p> <p>The Protocol Support Software is used to create communications sequences (macros).</p>	PMCR instruction

Note Refer to the operation/system manuals for details on the Host Link procedure, non-procedure communication, 1:1 links, and NT Links. This manual provides details on only protocol macros.

1-1-3 Communications Board Models

The following Communications Boards are available.

The features that are to be used from among those listed below as “YES” for any particular Communications Board is specified in the PC Setup at startup.

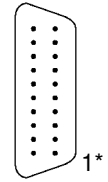
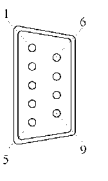
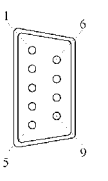
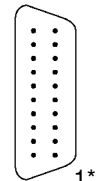
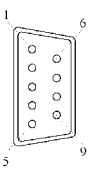
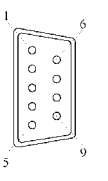
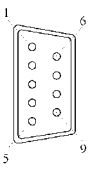
Type	Physical specification		Function					
			CPU bus	Host Link	Non-procedure	1:1 link	NT Link (1:1, 1:N)	Protocol macros
C200HW-COM01	Communications Unit connection port		YES	—	—	—	—	—
C200HW-COM02-V1 2*	RS-232C port		—	YES	YES	YES	YES	—
C200HW-COM03-V1 2*	RS-422A/485 port		—	YES	YES	YES	YES	—
C200HW-COM04-EV1 3*	Communications Unit connection port		YES	—	—	—	—	—
	RS-232C port		—	YES	YES	YES	YES	YES
C200HW-COM05-EV1 3*	RS-232C port		—	YES	YES	YES	YES	YES
	RS-232C port		—	YES	YES	YES	YES	YES

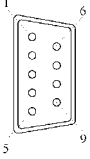
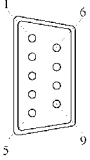
Type	Physical specification		Function					
			CPU bus	Host Link	Non-procedure	1:1 link	NT Link (1:1, 1:N)	Protocol macros
C200HW-COM06-EV1 3*	RS-232C port		—	YES	YES	YES	YES	YES
	RS-422A/485 port		—	YES	YES	YES	YES	YES

- 1* Interface to C200HW-CE001/CE002 Bus Connection Unit for Link Units such as Controller Link, SYSMAC LINK, or SYSMAC NET Link Units.
- 2* The RP command (program read) can be used in Host Link Mode when V1 Communications Boards are used with C200HX/C200HG/C200HE-CPU□□-ZE CPU Units. The RP command cannot be used with the previous version of Communications Boards (those without “V1” in the model number).
- 3* The following protocol macro functionality has been added to the V1 Communications Boards. The following are possible only for the C200HW-COM□□-(E)V1 Communications Boards.
 - SUM2 (SUM of two’s complement) and CRC-16 can be used for error checking.
 - The Repeat Counter N Present Value, a Sequence End Flag, and a Sequence Abort Flag are provided in the SR area.
 - The check code can be placed after the terminator in the message sequence.
 - The upper and lower bytes of the error check code can be swapped.

Note When using a 1:N Host Link, 1:N NT Link, or a protocol macro using a RS-232C port, a RS-232C-to-RS-422A/485 Link Adapter (NT-AL001) is required.

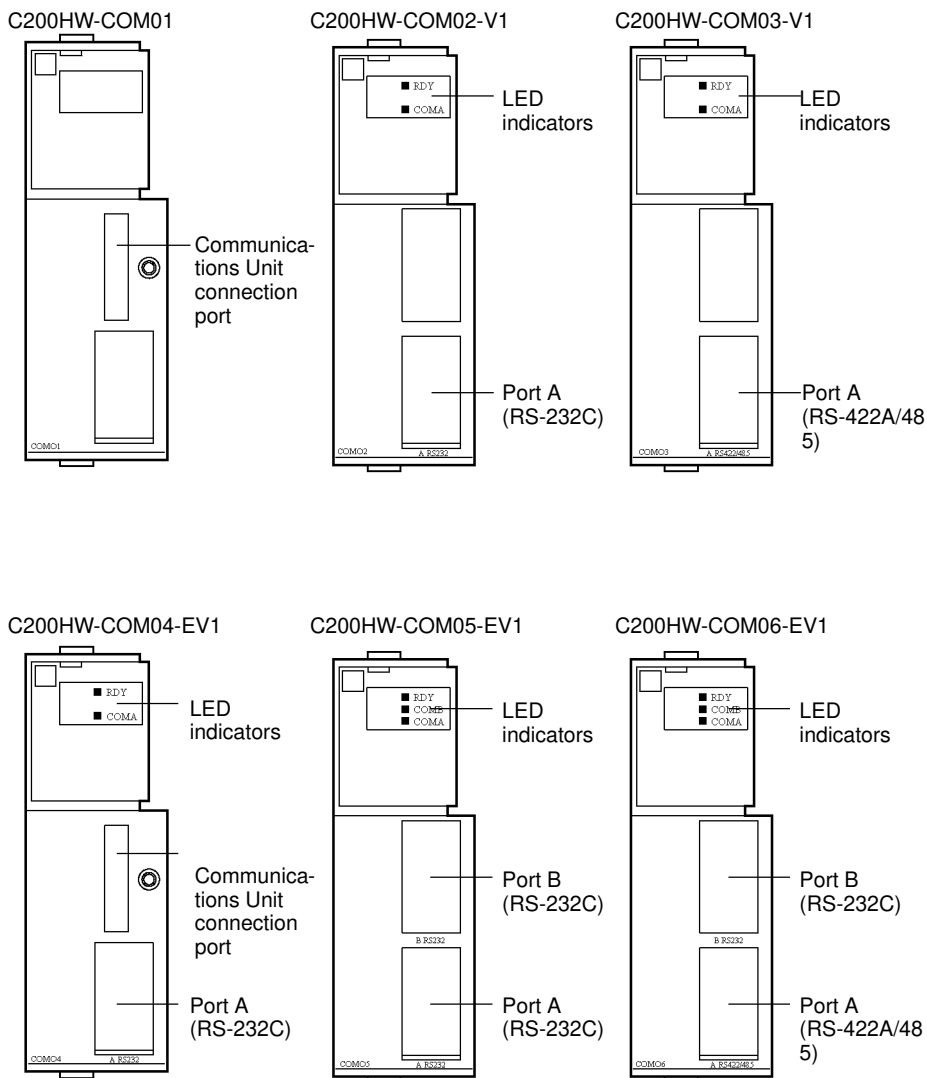

- Note**
1. V1 Communications Boards are compatible with C200HX/HG/HE-CPU□□-ZE CPU Units.
 2. EV1 Communications Boards are compatible with C200HX/HG/HE-CPU□□-ZE CPU Units and have improved protocol macro functionality.

1-1-4 DIP Switch Settings

To use port A (RS-422A/485) on the C200HW-COM03-V1 or C200HW-COM06-EV1, the DIP switches on the Communications Board must be set according to the application conditions.

RS-422A/485 Cable (SW1)

Set DIP switch SW1 as follows according to the type of the RS-422A/485 cable being used:

- 2-wire: Set to 2
- 4-wire: Set to 4

Terminator (SW2)

When a Communications Board is the terminator for a 1:N link during communications, turn ON this switch on the last Board and turn OFF this switch on the rest of the Boards.

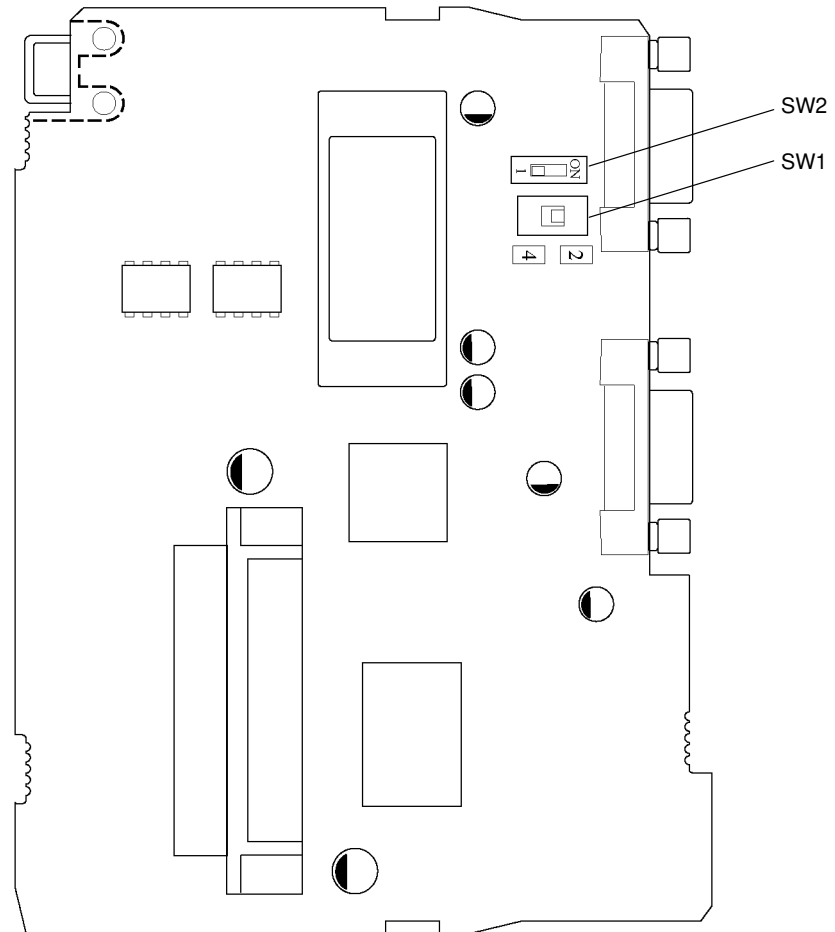

The factory settings are as follows.

DIP switch SW1: 2 (2-wire)

DIP switch SW2: 1 (Terminator OFF)

1-1-5 Applicable CPU Units

The following table lists the models of CPU Units to which Communications Boards can be installed in the option slot.

C200HX	C200HG	C200HE
C200HX-CPU64-E	C200HG-CPU63-E	C200HE-CPU42-E
C200HX-CPU54-E	C200HG-CPU53-E	C200HE-CPU32-E
C200HX-CPU44-E	C200HG-CPU43-E	
C200HX-CPU34-E	C200HG-CPU33-E	
C200HX-CPU85-ZE	C200HG-CPU63-ZE	C200HE-CPU42-ZE
C200HX-CPU65-ZE	C200HG-CPU53-ZE	C200HE-CPU32-ZE
C200HX-CPU64-ZE	C200HG-CPU43-ZE	
C200HX-CPU54-ZE	C200HG-CPU33-ZE	
C200HX-CPU44-ZE		
C200HX-CPU34-ZE		

1-1-6 Installation

The following describes how to install a Communications Board in the option slot of the CPU Unit.

⚠ Caution Always turn off the power supply before installing or removing a Communications Board. If the power supply is kept ON while a Communications Board is being installed or removed, operational errors can occur in the CPU Unit, internal devices may be destroyed, or communications may fail.

- 1, 2, 3...** 1. Open the Memory Cassette cover.

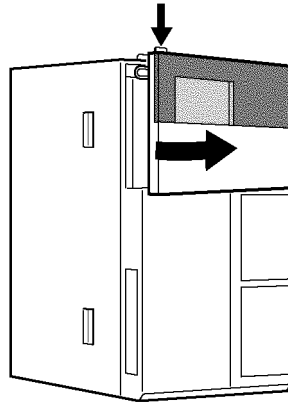

2. Remove the Communications Board cover.

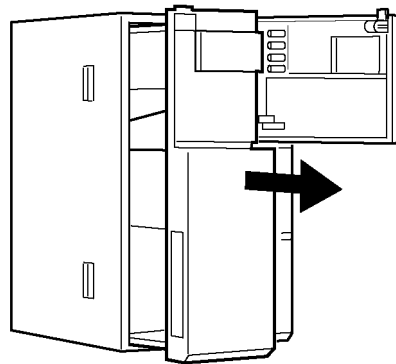

3. Slide in the Communications Board in slit and press it all the way to the back.

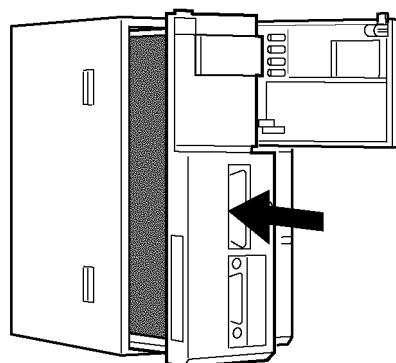

4. Close the Memory Cassette cover.

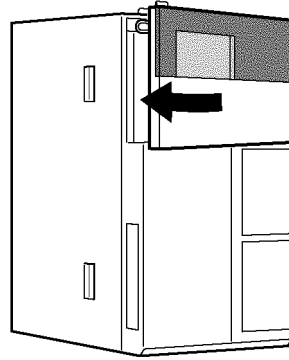

1-1-7 Indicators

The status of the Communications Board is displayed on the LED indicators on the front of the CPU Unit.

Indicator	Color	Status	Meaning	Contents
RDY	Green	OFF	Not Ready	Communications Board hardware error
		Flash	Setting error	The system setup or the contents of the protocol data contains an error.
		ON	Ready	The Communications Board is operating normally and communications are enabled.
COMB	Orange	Flash	Communicating	Port B is being used for communications (ON when there is data).
COMA	Orange	Flash	Communicating	Port A is being used for communications (ON when there is data)

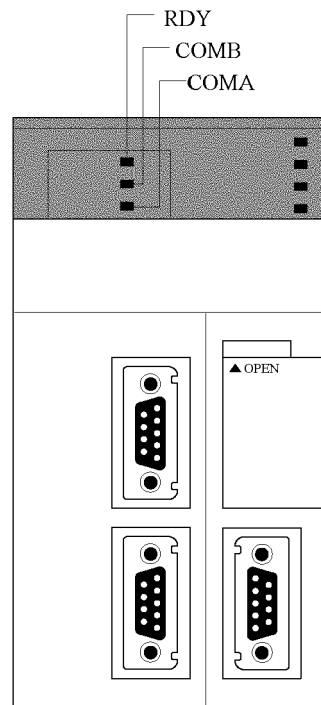

Note The above description is based on the C200HW-COM05-EV1 and C200HW-COM06-EV1.

1-1-8 Communications Board Specifications

Item	C200HW-COM01	C200HW-COM02-V1	C200HW-COM03-V1	C200HW-COM04-EV1	C200HW-COM05-EV1	C200HW-COM06-EV1
Current consumption at 5 V	0.03 A	0.1 A	0.2 A	0.1 A	0.1 A	0.2 A
External dimensions	42.5 × 134 × 98 mm (W × H × D)					
Weight	100 g max.	100 g max.	105 g max.	110 g max.	110 g max.	115 g max.
Standard accessories	---	Plug: XM2A-0901 (OMRON) × 1 Hood: XM2S-0911 (OMRON) × 1			Plug: XM2A-0901 (OMRON) × 2 Hood: XM2S-0911 (OMRON) × 2	

1-1-9 Basic Specifications

The basic specifications will be determined by the basic specifications of the C200HX/HG/HE(-Z) PC used.

1-1-10 Communications Specifications

The following tables provide the communications specifications of RS-232C and RS-422A/485 ports.

RS-232C Port

Item	Specification
Communications method	Half duplex
Synchronization	Start-stop
Baud rate	1,200/2,400/4,800/9,600/19,200 bps
Transmission method	Point-to-point
Transmission distance	15 m max.
Interface	Complies with EIA RS-232C

Connector Pin Assignment

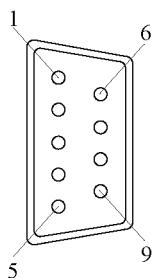

Pin No.	Signal name	Abbreviation	Signal direction
1	Safety ground	FG	–
2	Send data	SD	Output
3	Receive data	RD	Input
4	Send request	RS	Output
5	Send enabled	CS	Input
6	Power supply	5V	–
7	Dataset ready	DR	Input
8	Data terminal ready	ER	Output
9	Signal ground	SG	–
Shell	Safety ground	FG	–

Connectors

Plug: XM2A-0901 (OMRON) or equivalent
Hood: XM2S-0911 (OMRON) or equivalent

Note One plug and one hood are provided.

Recommended Cable

AWG28 × 5P IFVV-SB (manufactured by FUJIKURA DENSEN)
CO-MAVV-SB 5P × AWG28 (manufactured by HITACHI DENSEN)
Line length: 15 m max.

RS-422A/485 Port

Item	Specification
Communications method	Half duplex
Synchronization	Start-stop
Baud rate	1,200/2,400/4,800/9,600/19,200 bps
Transmission method	Point-to-multipoint
Transmission distance	500 m max.
Interface	Complies with EIA RS-422A/485

Connector Pin Assignment

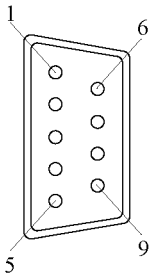

Pin No.	Signal name	Abbreviation	Signal direction
1	Send data -	SDA	Output
2	Send data +	SDB	Output
3	Unused	NC	-
4	Unused	NC	-
5	Unused	NC	-
6	Receive data -	RDA	Input
7	Unused	NC	-
8	Receive data +	RDB	Input
9	Unused	NC	-
Shell	Safety ground	FG	-

Note When the 2-wire communications is set, use 1 and 2, or 6 and 8.

Connectors

Plug: XM2A-0901 (OMRON) or equivalent
 Hood: XM2S-0911 (OMRON) or equivalent

Note One plug and one hood are provided.

Recommended Cable

AWG28 × 5P IFVV-SB (manufactured by FUJIKURA DENSEN)
 CO-MAVV-SB 5P × AWG28 (manufactured by HITACHI DENSEN)
 Line length: 500 m max.

1-1-11 Communications Modes and Transmission Paths

The following table shows the transmission paths that can be used for each of the communications modes.

Communications mode	RS-232C	4-wire 1:1	4-wire 1:N	2-wire 1:1	2-wire 1:N
1:N Host Link	YES	YES	YES	NO	NO
Non-procedure	YES	YES	YES	NO	NO
1:1 link	YES	YES	NO	NO	NO
1:1 NT Link	YES	YES	NO	NO	NO
1:N NT Link	NO	YES	YES	YES	YES
Protocol macros	YES	YES	YES	YES	YES