



Chipsmall Limited consists of a professional team with an average of over 10 year of expertise in the distribution of electronic components. Based in Hongkong, we have already established firm and mutual-benefit business relationships with customers from,Europe,America and south Asia,supplying obsolete and hard-to-find components to meet their specific needs.

With the principle of “Quality Parts,Customers Priority,Honest Operation,and Considerate Service”,our business mainly focus on the distribution of electronic components. Line cards we deal with include Microchip,ALPS,ROHM,Xilinx,Pulse,ON,Everlight and Freescale. Main products comprise IC,Modules,Potentiometer,IC Socket,Relay,Connector.Our parts cover such applications as commercial,industrial, and automotives areas.

We are looking forward to setting up business relationship with you and hope to provide you with the best service and solution. Let us make a better world for our industry!



## Contact us

Tel: +86-755-8981 8866 Fax: +86-755-8427 6832

Email & Skype: info@chipsmall.com Web: www.chipsmall.com

Address: A1208, Overseas Decoration Building, #122 Zhenhua RD., Futian, Shenzhen, China



# Xinger®



## Ultra Low Profile 0805 3 dB, 90° Hybrid Coupler

### Description

The C2023J5003AHF is a low cost, low profile sub-miniature high performance 3 dB coupler in an easy to use surface mount package. It is designed for WiMax, WiBro, UMTS, and IMT2000 applications. The C2023J5003AHF is ideal for balanced power and low noise amplifiers, plus signal distribution and other applications where low insertion loss and tight amplitude and phase balance are required. The C2023J5003AHF is available on tape and reel for pick and place high volume manufacturing.

All of the Xinger components are constructed from ceramic filled PTFE composites which possess excellent electrical and mechanical stability. All parts have been subjected to rigorous qualification testing and units are 100% RF tested.

### Detailed Electrical Specifications: Specifications subject to change without notice.

Features:	Parameter	ROOM (25°C)			Unit
		Min.	Typ.	Max	
<ul style="list-style-type: none"> <li>• 1985 – 2350 MHz</li> <li>• 0.7mm Height Profile</li> <li>• WiMax, WiBro, UMTS &amp; IMT2000 applications</li> <li>• High Isolation &amp; Low Loss</li> <li>• Surface Mountable</li> <li>• Tape &amp; Reel</li> <li>• Non-conductive Surface</li> <li>• RoHS Compliant</li> <li>• Halogen-Free</li> </ul>	Frequency	1985		2350	MHz
	Port Impedance		50		Ω
	Return Loss	18	22		dB
	Isolation	21	25		dB
	Insertion Loss*		0.3	0.4	dB
	Amplitude Balance		0.1	0.8	dB
	Phase Balance (relative to 90°)		2	6	Degrees
	Power Handling @ 85C			4	Watts
	Power Handling @ 105C			3	Watts
	Operating Temperature		-55		+105

\* Insertion Loss stated at room temperature (Insertion Loss is approximately 0.1 dB higher at +85 °C)

### Outline Drawing

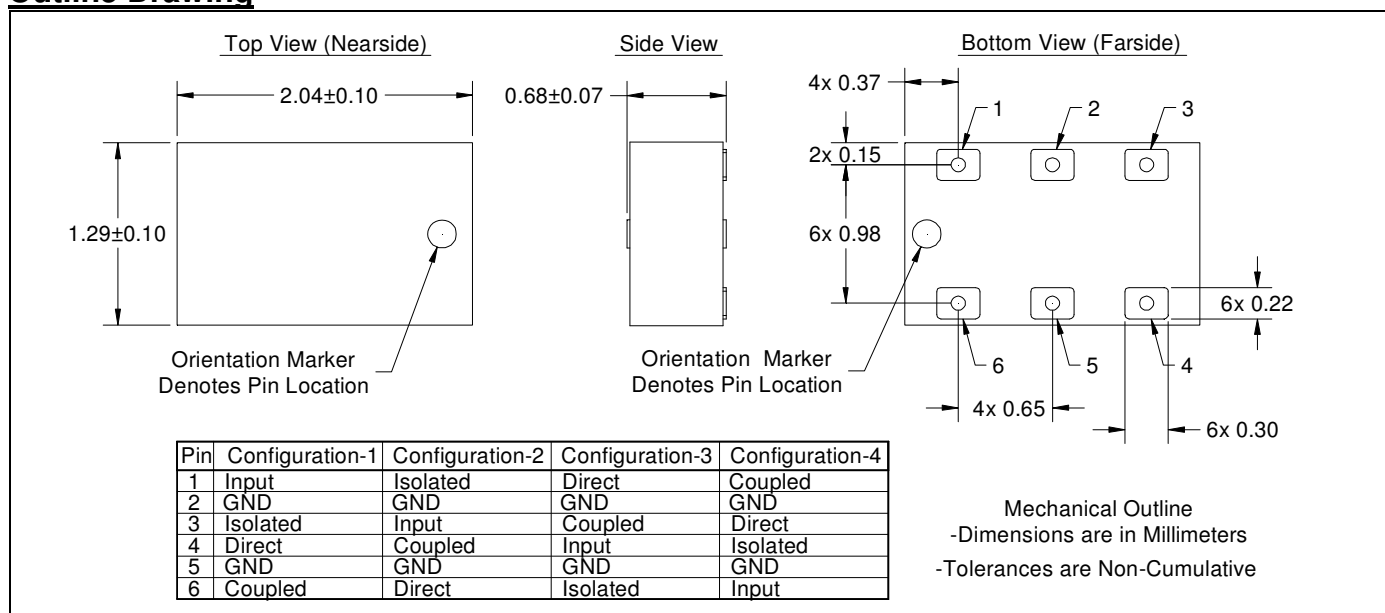

## Typical Broadband Performance: 500 MHz. to 6000 MHz.

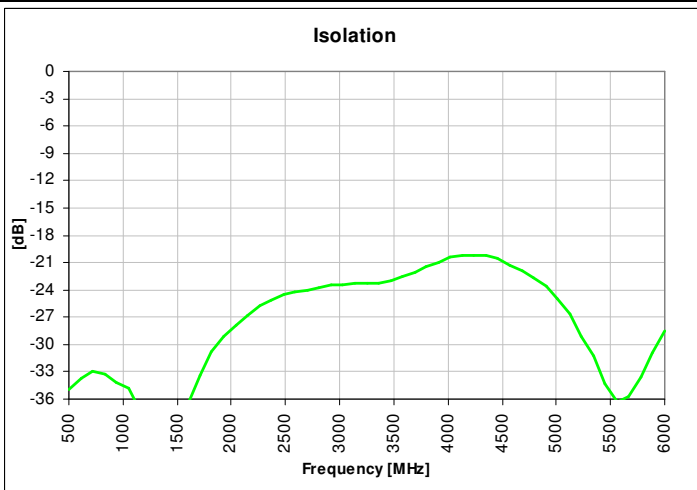
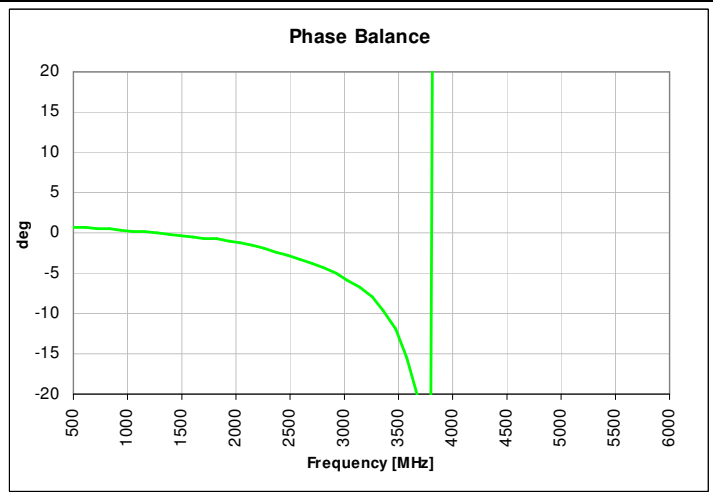
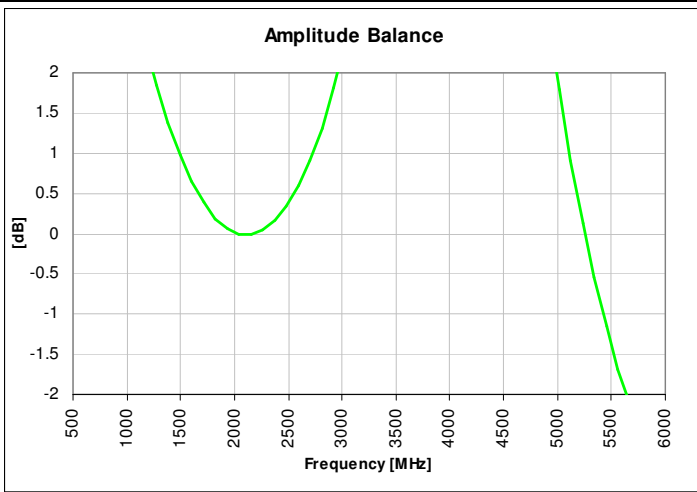
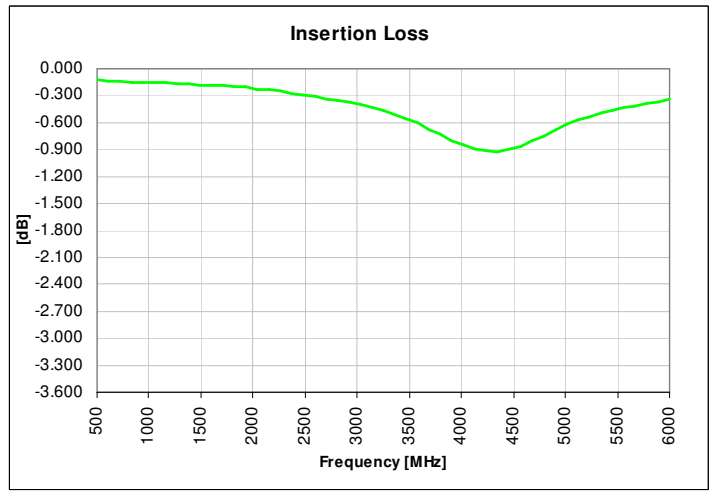
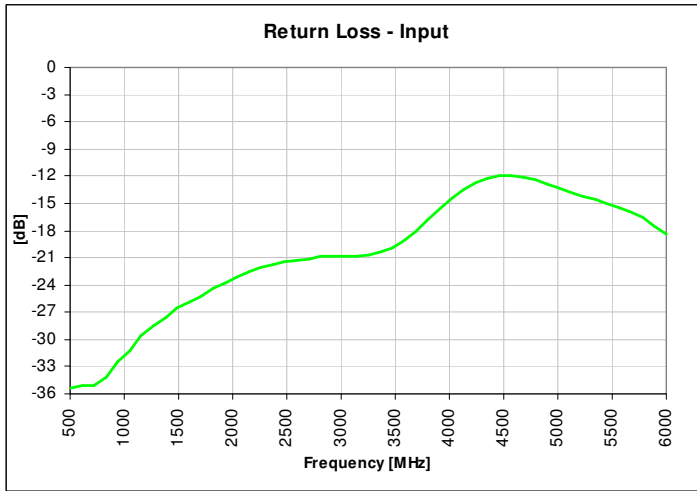

### Typical Performance: 1900 MHz. to 2400 MHz.

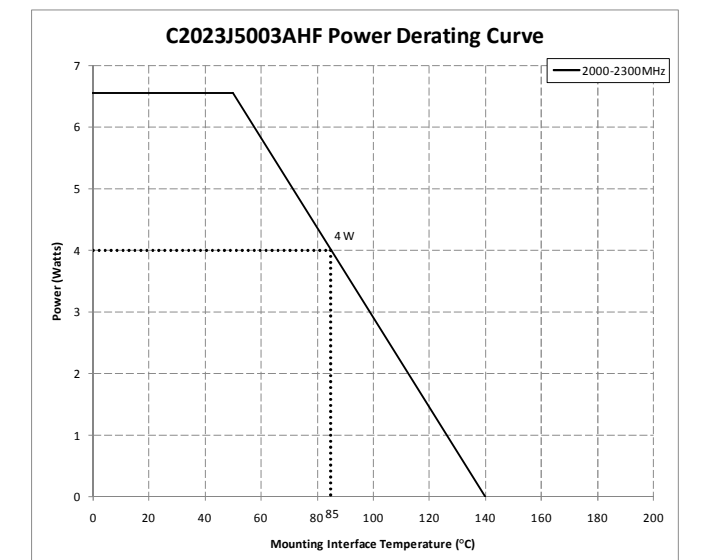
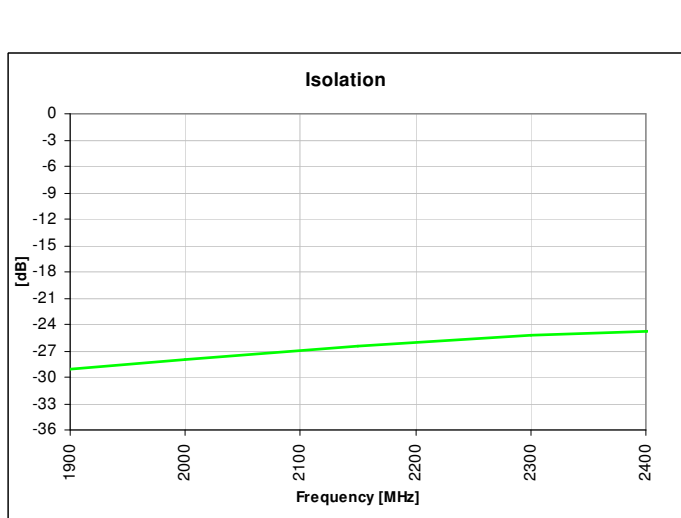
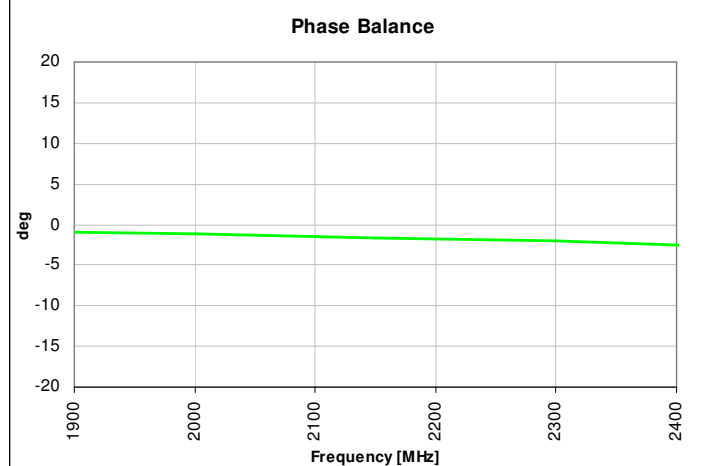
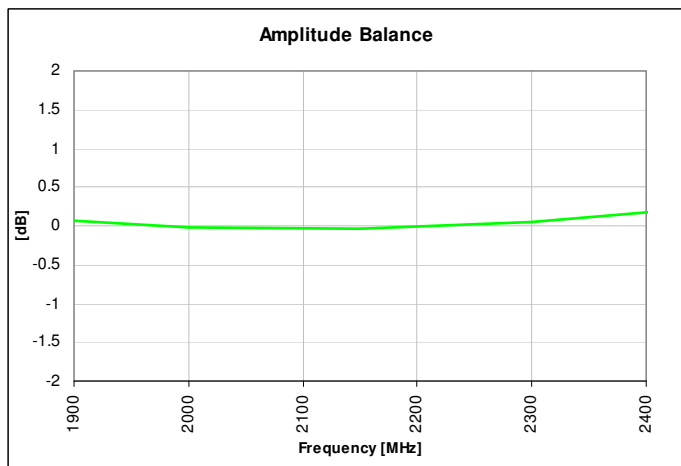
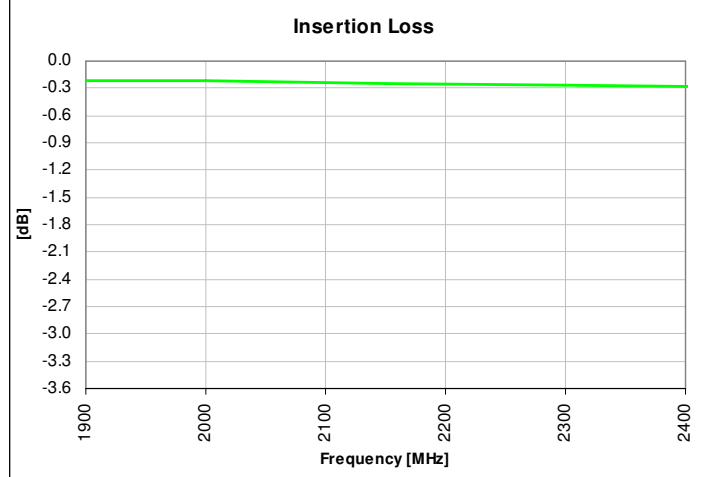
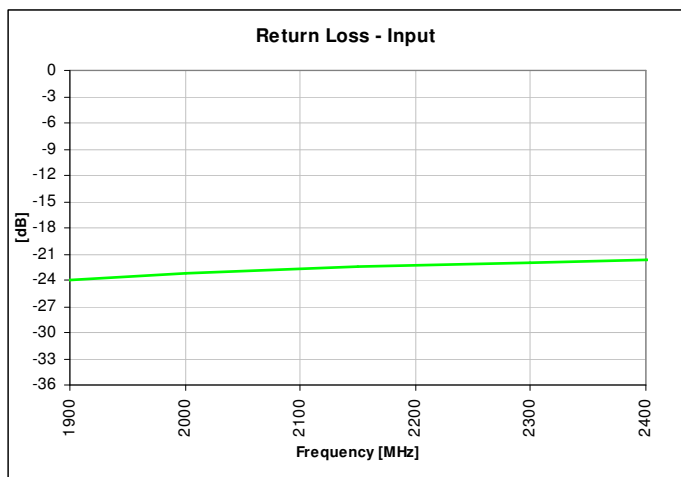

**Definition of Measured Specifications**

Parameter	Definition	<b>Mathematical Representation</b> <i>i, j, k, m</i> is denoted as the port index of input, isolated, direct and coupled port for specific pin configuration shown in the table
<b>Return Loss</b>	The impedance match of the coupler to a 50Ω system. Return Loss is an alternate means to express VSWR.	$20\log_{10}( S_{ii} )$
<b>Isolation</b>	The input power divided by the sum of the power at the two output ports.	$20\log_{10} S_{ji} $
<b>Insertion Loss</b>	The input power divided by the sum of the power at the two output ports.	$10\log_{10}( S_{mi} ^2 +  S_{ki} ^2)$
<b>Amplitude Balance</b>	The difference in power between the two outputs.	$20\log_{10}\left(\frac{ S_{ki} }{ S_{mi} }\right)$
<b>Phase Balance</b>	The difference in phase angle between the two output ports.	$\angle S_{ki} - \angle S_{mi} + 90^\circ$

\*100% RF test is performed per spec definition for pin configuration 1 and port 1 (input port) is connected to pin1, port 2 (isolated port) is connected to pin 3, port 3 (direct port) is connected to pin 4 and port 4 (isolated) is connected to pin 6.

### Mounting Configuration:

In order for Xinger surface mount components to work optimally, the proper impedance transmission lines must be used to connect to the RF ports. If this condition is not satisfied, insertion loss, Isolation and VSWR may not meet published specifications.

All of the Xinger components are constructed from organic PTFE based composites which possess excellent electrical and mechanical stability. Xinger components are compliant to a variety of ROHS and Green standards and ready for Pb-free soldering processes. Pads are Gold plated with a Nickel barrier.

An example of the PCB footprint used in the testing of these parts is shown below. In specific designs, the transmission line widths need to be adjusted to the unique dielectric coefficients and thicknesses as well as varying pick and place equipment tolerances.

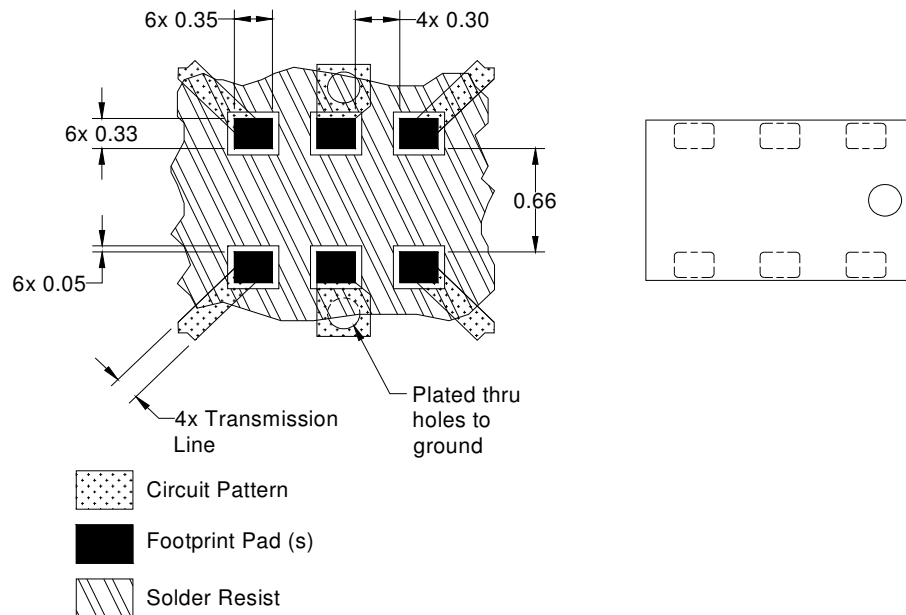

Dimensions are in Millimeters  
Mounting Footprint

## Packaging and Ordering Information

Parts are available in reel and are packaged per EIA 481-2. Parts are oriented in tape and reel as shown below. Minimum order quantities are 4000 per reel.

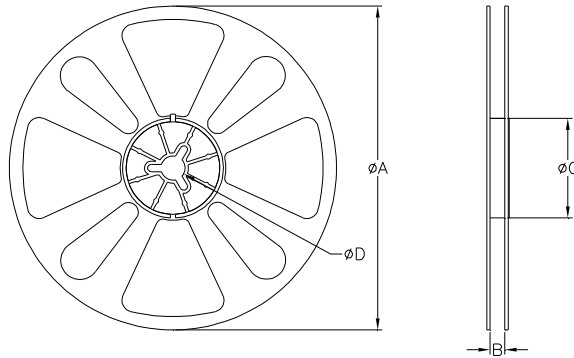
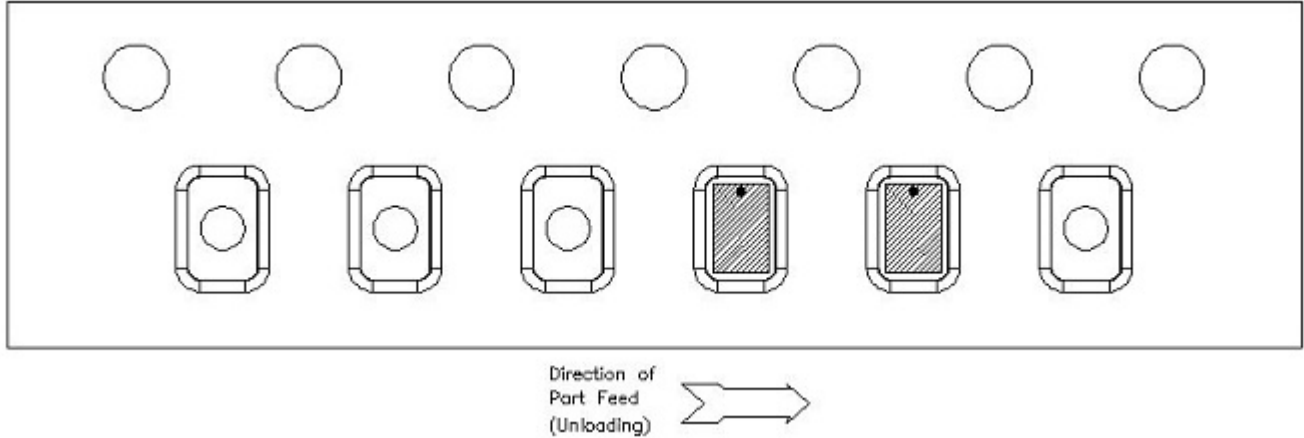

TABLE 1		
QUANTITY/REEL	REEL DIMENSIONS mm	
4000	$\phi A$	177.80
	B	8.00
	$\phi C$	50.80
	$\phi D$	13.00