



Chipsmall Limited consists of a professional team with an average of over 10 year of expertise in the distribution of electronic components. Based in Hongkong, we have already established firm and mutual-benefit business relationships with customers from,Europe,America and south Asia,supplying obsolete and hard-to-find components to meet their specific needs.

With the principle of “Quality Parts,Customers Priority,Honest Operation,and Considerate Service”,our business mainly focus on the distribution of electronic components. Line cards we deal with include Microchip,ALPS,ROHM,Xilinx,Pulse,ON,Everlight and Freescale. Main products comprise IC,Modules,Potentiometer,IC Socket,Relay,Connector.Our parts cover such applications as commercial,industrial, and automotives areas.

We are looking forward to setting up business relationship with you and hope to provide you with the best service and solution. Let us make a better world for our industry!



Contact us

Tel: +86-755-8981 8866 Fax: +86-755-8427 6832

Email & Skype: info@chipsmall.com Web: www.chipsmall.com

Address: A1208, Overseas Decoration Building, #122 Zhenhua RD., Futian, Shenzhen, China



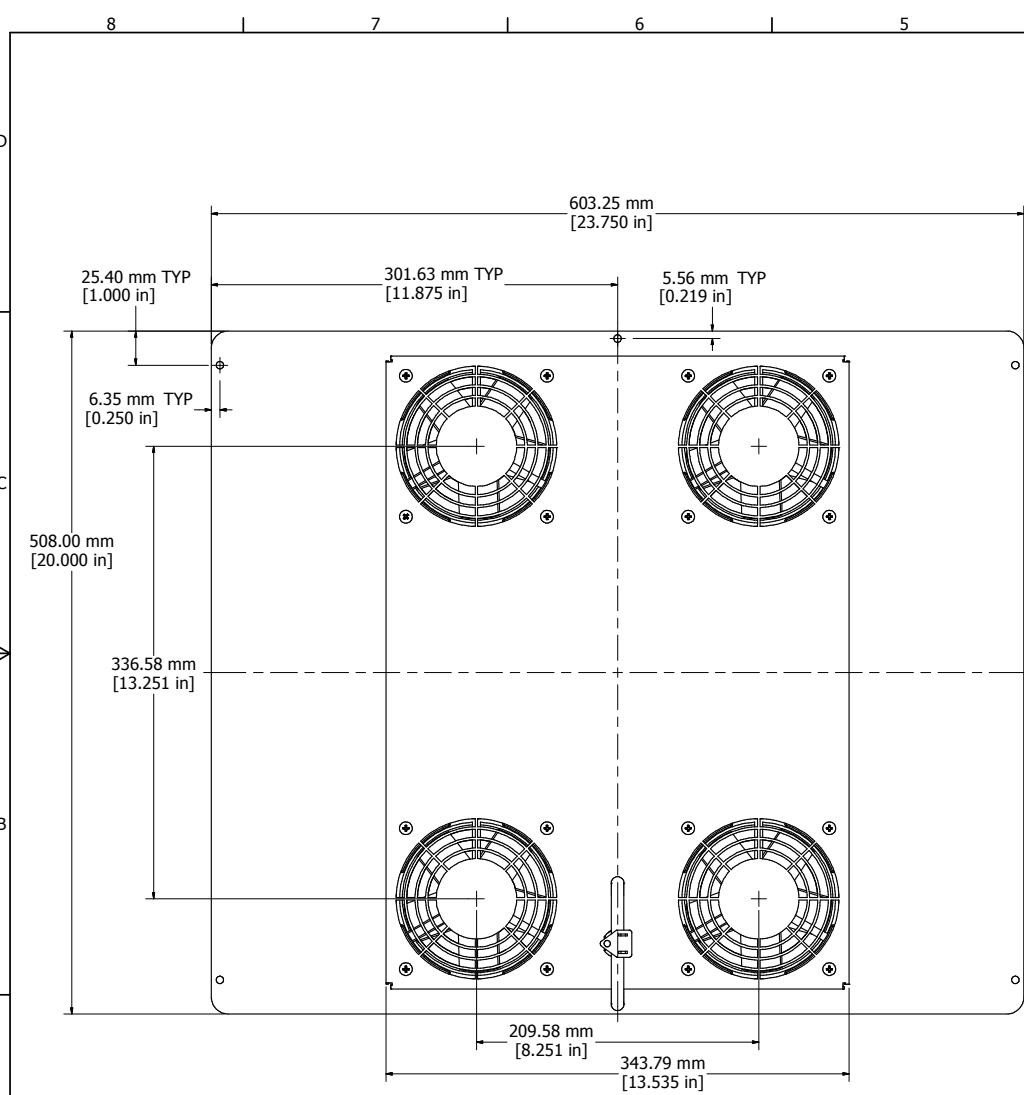

ASSEMBLY - VIEW FROM BOTTOM

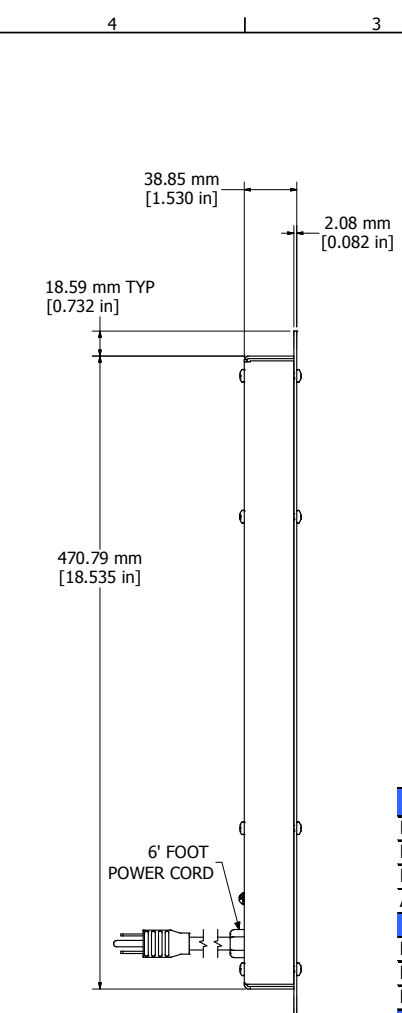

ASSEMBLY - VIEW FROM SIDE



ISOMETRIC VIEW

C2T1931F4
Finish - Top - Painted Steel
Rated - 115 VAC, 50/60 Hz, 0.77 Amps
Free Flow Air Delivery - 400 CFM
Approvals - cURus Recognized UL507 and CSA C22.2 No.113
COLOURS
Black - C2T1931F4BK1
Beige - C2T1931F4CG1
Light Grey - C2T1931F4LG1
HARDWARE
6 Screws - RoundHead 8-32 x 1/2"
6 Speed Nuts

**HAMMOND
MANUFACTURING™**

C2T1931F4

www.hammondmfg.com