



Chipsmall Limited consists of a professional team with an average of over 10 year of expertise in the distribution of electronic components. Based in Hongkong, we have already established firm and mutual-benefit business relationships with customers from,Europe,America and south Asia,supplying obsolete and hard-to-find components to meet their specific needs.

With the principle of “Quality Parts,Customers Priority,Honest Operation,and Considerate Service”,our business mainly focus on the distribution of electronic components. Line cards we deal with include Microchip,ALPS,ROHM,Xilinx,Pulse,ON,Everlight and Freescale. Main products comprise IC,Modules,Potentiometer,IC Socket,Relay,Connector.Our parts cover such applications as commercial,industrial, and automotives areas.

We are looking forward to setting up business relationship with you and hope to provide you with the best service and solution. Let us make a better world for our industry!



Contact us

Tel: +86-755-8981 8866 Fax: +86-755-8427 6832

Email & Skype: info@chipsmall.com Web: www.chipsmall.com

Address: A1208, Overseas Decoration Building, #122 Zhenhua RD., Futian, Shenzhen, China



3900 Metal Toggle Switches 16A 250Vac - IP67 Sealed Versions



- ▶ Metal toggle switches
- ▶ Ratings up to 20A, 277V ac
- ▶ Single and double pole
- ▶ Choice of circuits including 3 position and momentary
- ▶ Sealed version supplied complete with gaskets
- ▶ Panel seal version to IP67
- ▶ 6.3mm terminals
- ▶ Guard option

Approvals and specifications



16(4)A 250Vac T85 (3900 & 3950)
10(4)A 250Vac T85 (All other circuits)



UL CSA* 20A 125/277Vac (ON-OFF Circuits)
UL CSA* 16A 125/277Vac (Other Circuits)
UL CSA* 7A 72Vdc, 14A 36Vdc
UL 250Vac 1hp, 125Vac 1/2hp
UL 65°C, file E45221, CSA file LR10990

Approvals and ratings vary with function.
3mm contact gap except where marked μ .
Technical data on pages 4 & 5.
* CSA approval for A and B bodies only

toggle switches

C 3900 B E - - -

TERMINAL FUNCTION ACTUATOR BODY OPTIONS

TERMINAL	FUNCTION	ACTUATOR	
C 6.3 x 0.8	Single pole 	B metal Metal toggle finish is nickel plate	
	3900 		3950
	3901 		3951
	3902 		3952
	3910 		3960
	3911 		3961
	3920 		3970
	3921 		3971
	3922 		3972
	Other terminals to special order		

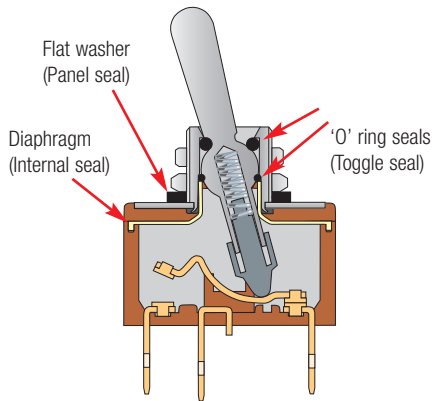

Toggle switch - sealed version
BE and BF types



Guard R17-10



C3900BE ---



C3920BA ---



C3950BF ---



C3972BB ---

BODY

A
Single pole

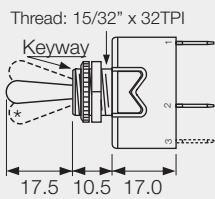

E
Panel sealed, single pole

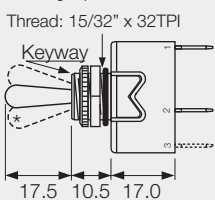

B
Double pole

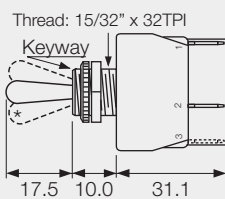

F
Panel sealed, double pole

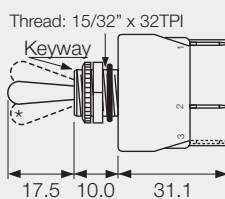

OPTIONS

Neck Seal A0539MOAAA
Actuator is visible



Cover A1080MOAAA



Covers have internal nylon nuts

Fixing nuts

Nickel plated brass are supplied



Hex Back nut



Knurled Front nut
Panel thickness 4.0 with backnut

Plate F00232PAAA
Plate SP or DP



DIMENSIONS (mm) * Indicates ON position (for ON - OFF switches)

Single Pole

(C terminals shown)

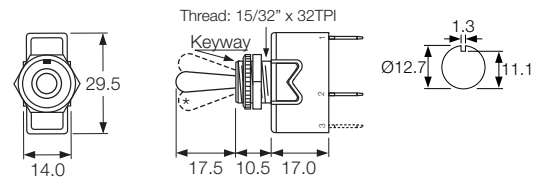

A Body

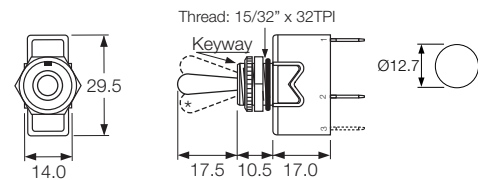

E body (panel sealed)

Double Pole

(C terminals shown with barrier)

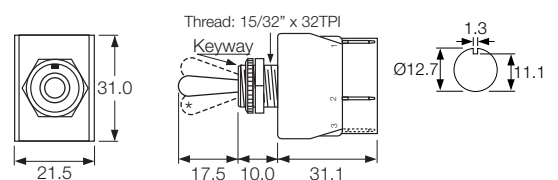

B Body

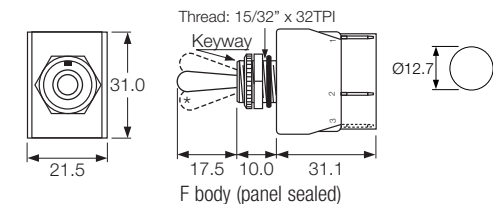

F body (panel sealed)