



Chipsmall Limited consists of a professional team with an average of over 10 year of expertise in the distribution of electronic components. Based in Hongkong, we have already established firm and mutual-benefit business relationships with customers from,Europe,America and south Asia,supplying obsolete and hard-to-find components to meet their specific needs.

With the principle of “Quality Parts,Customers Priority,Honest Operation,and Considerate Service”,our business mainly focus on the distribution of electronic components. Line cards we deal with include Microchip,ALPS,ROHM,Xilinx,Pulse,ON,Everlight and Freescale. Main products comprise IC,Modules,Potentiometer,IC Socket,Relay,Connector.Our parts cover such applications as commercial,industrial, and automotives areas.

We are looking forward to setting up business relationship with you and hope to provide you with the best service and solution. Let us make a better world for our industry!



## Contact us

Tel: +86-755-8981 8866 Fax: +86-755-8427 6832

Email & Skype: info@chipsmall.com Web: www.chipsmall.com

Address: A1208, Overseas Decoration Building, #122 Zhenhua RD., Futian, Shenzhen, China



Cat. No. W350-E1-02

# **SYSMAC CVM1D Duplex System Programmable Controllers**

## **INSTALLATION GUIDE**

**OMRON®**



# **SYSMAC CVM1D Duplex System Programmable Controllers**

## **Installation Guide**

*Produced July 2000*

# Terms and Conditions of Sale

1. **Offer: Acceptance.** These terms and conditions (these "Terms") are deemed part of all quotes, agreements, purchase orders, acknowledgments, price lists, catalogs, manuals, brochures and other documents, whether electronic or in writing, relating to the sale of products or services (collectively, the "Products") by Omron Electronics LLC and its subsidiary companies ("Omron"). Omron objects to any terms or conditions proposed in Buyer's purchase order or other documents which are inconsistent with, or in addition to, these Terms.
2. **Prices: Payment Terms.** All prices stated are current, subject to change without notice by Omron. Omron reserves the right to increase or decrease prices on any unshipped portions of outstanding orders. Payments for Products are due net 30 days unless otherwise stated in the invoice.
3. **Discounts.** Cash discounts, if any, will apply only on the net amount of invoices sent to Buyer after deducting transportation charges, taxes and duties, and will be allowed only if (i) the invoice is paid according to Omron's payment terms and (ii) Buyer has no past due amounts.
4. **Interest.** Omron, at its option, may charge Buyer 1-1/2% interest per month or the maximum legal rate, whichever is less, on any balance not paid within the stated terms.
5. **Orders.** Omron will accept no order less than \$200 net billing.
6. **Governmental Approvals.** Buyer shall be responsible for, and shall bear all costs involved in, obtaining any government approvals required for the importation or sale of the Products.
7. **Taxes.** All taxes, duties and other governmental charges (other than general real property and income taxes), including any interest or penalties thereon, imposed directly or indirectly on Omron or required to be collected directly or indirectly by Omron for the manufacture, production, sale, delivery, importation, consumption or use of the Products sold hereunder (including customs duties and sales, excise, use, turnover and license taxes) shall be charged to and remitted by Buyer to Omron.
8. **Financial.** If the financial position of Buyer at any time becomes unsatisfactory to Omron, Omron reserves the right to stop shipments or require satisfactory security or payment in advance. If Buyer fails to make payment or otherwise comply with these Terms or any related agreement, Omron may (without liability and in addition to other remedies) cancel any unshipped portion of Products sold hereunder and stop any Products in transit until Buyer pays all amounts, including amounts payable hereunder, whether or not then due, which are owing to it by Buyer. Buyer shall in any event remain liable for all unpaid accounts.
9. **Cancellation: Etc.** Orders are not subject to rescheduling or cancellation unless Buyer indemnifies Omron against all related costs or expenses.
10. **Force Majeure.** Omron shall not be liable for any delay or failure in delivery resulting from causes beyond its control, including earthquakes, fires, floods, strikes or other labor disputes, shortage of labor or materials, accidents to machinery, acts of sabotage, riots, delay in or lack of transportation or the requirements of any government authority.
11. **Shipping: Delivery.** Unless otherwise expressly agreed in writing by Omron:
  - a. Shipments shall be by a carrier selected by Omron; Omron will not drop ship except in "break down" situations.
  - b. Such carrier shall act as the agent of Buyer and delivery to such carrier shall constitute delivery to Buyer;
  - c. All sales and shipments of Products shall be FOB shipping point (unless otherwise stated in writing by Omron), at which point title and risk of loss shall pass from Omron to Buyer; provided that Omron shall retain a security interest in the Products until the full purchase price is paid;
  - d. Delivery and shipping dates are estimates only; and
  - e. Omron will package Products as it deems proper for protection against normal handling and extra charges apply to special conditions.
12. **Claims.** Any claim by Buyer against Omron for shortage or damage to the Products occurring before delivery to the carrier must be presented in writing to Omron within 30 days of receipt of shipment and include the original transportation bill signed by the carrier noting that the carrier received the Products from Omron in the condition claimed.
13. **Warranties.** (a) **Exclusive Warranty.** Omron's exclusive warranty is that the Products will be free from defects in materials and workmanship for a period of twelve months from the date of sale by Omron (or such other period expressed in writing by Omron). Omron disclaims all other warranties, express or implied. (b) **Limitations.** OMRON MAKES NO WARRANTY OR REPRESENTATION, EXPRESS OR IMPLIED, ABOUT NON-INFRINGEMENT, MERCHANTABILITY OR FITNESS FOR A PARTICULAR PURPOSE OF THE PRODUCTS. BUYER ACKNOWLEDGES THAT IT ALONE HAS DETERMINED THAT THE PRODUCTS WILL SUITABLY MEET THE REQUIREMENTS OF THEIR INTENDED USE. Omron further disclaims all warranties and responsibility of any type for claims or expenses based on infringement by the Products or otherwise of any intellectual property right. (c) **Buyer Remedy.** Omron's sole obligation hereunder shall be, at Omron's election, to (i) replace (in the form originally shipped with Buyer responsible for labor charges for removal or replacement thereof) the non-complying Product, (ii) repair the non-complying Product, or (iii) repay or credit Buyer an amount equal to the purchase price of the non-complying Product; provided that in no event shall Omron be responsible for warranty, repair, indemnity or any other claims or expenses regarding the Products unless Omron's analysis confirms that the Products were properly handled, stored, installed and maintained and not subject to contamination, abuse, misuse or inappropriate modification. Return of any Products by Buyer must be approved in writing by Omron before shipment. Omron Companies shall not be liable for the suitability or unsuitability or the results from the use of Products in combination with any electrical or electronic components, circuits, system assemblies or any other materials or substances or environments. Any advice, recommendations or information given orally or in writing, are not to be construed as an amendment or addition to the above warranty. See <http://oeweb.omron.com> or contact your Omron representative for published information.
14. **Limitation on Liability: Etc.** OMRON COMPANIES SHALL NOT BE LIABLE FOR SPECIAL, INDIRECT, INCIDENTAL, OR CONSEQUENTIAL DAMAGES, LOSS OF PROFITS OR PRODUCTION OR COMMERCIAL LOSS IN ANY WAY CONNECTED WITH THE PRODUCTS, WHETHER SUCH CLAIM IS BASED IN CONTRACT, WARRANTY, NEGLIGENCE OR STRICT LIABILITY. Further, in no event shall liability of Omron Companies exceed the individual price of the Product on which liability is asserted.
15. **Indemnities.** Buyer shall indemnify and hold harmless Omron Companies and their employees from and against all liabilities, losses, claims, costs and expenses (including attorney's fees and expenses) related to any claim, investigation, litigation or proceeding (whether or not Omron is a party) which arises or is alleged to arise from Buyer's acts or omissions under these Terms or in any way with respect to the Products. Without limiting the foregoing, Buyer (at its own expense) shall indemnify and hold harmless Omron and defend or settle any action brought against such Companies to the extent based on a claim that any Product made to Buyer specifications infringed intellectual property rights of another party.
16. **Property: Confidentiality.** Any intellectual property in the Products is the exclusive property of Omron Companies and Buyer shall not attempt to duplicate it in any way without the written permission of Omron. Notwithstanding any charges to Buyer for engineering or tooling, all engineering and tooling shall remain the exclusive property of Omron. All information and materials supplied by Omron to Buyer relating to the Products are confidential and proprietary, and Buyer shall limit distribution thereof to its trusted employees and strictly prevent disclosure to any third party.
17. **Export Controls.** Buyer shall comply with all applicable laws, regulations and licenses regarding (i) export of products or information; (iii) sale of products to "forbidden" or other proscribed persons; and (ii) disclosure to non-citizens of regulated technology or information.
18. **Miscellaneous.** (a) **Waiver.** No failure or delay by Omron in exercising any right and no course of dealing between Buyer and Omron shall operate as a waiver of rights by Omron. (b) **Assignment.** Buyer may not assign its rights hereunder without Omron's written consent. (c) **Law.** These Terms are governed by the law of the jurisdiction of the home office of the Omron company from which Buyer is purchasing the Products (without regard to conflict of law principles). (d) **Amendment.** These Terms constitute the entire agreement between Buyer and Omron relating to the Products, and no provision may be changed or waived unless in writing signed by the parties. (e) **Severability.** If any provision hereof is rendered ineffective or invalid, such provision shall not invalidate any other provision. (f) **Setoff.** Buyer shall have no right to set off any amounts against the amount owing in respect of this invoice. (g) **Definitions.** As used herein, "including" means "including without limitation"; and "Omron Companies" (or similar words) mean Omron Corporation and any direct or indirect subsidiary or affiliate thereof.

## Certain Precautions on Specifications and Use

1. **Suitability of Use.** Omron Companies shall not be responsible for conformity with any standards, codes or regulations which apply to the combination of the Product in the Buyer's application or use of the Product. At Buyer's request, Omron will provide applicable third party certification documents identifying ratings and limitations of use which apply to the Product. This information by itself is not sufficient for a complete determination of the suitability of the Product in combination with the end product, machine, system, or other application or use. Buyer shall be solely responsible for determining appropriateness of the particular Product with respect to Buyer's application, product or system. Buyer shall take application responsibility in all cases but the following is a non-exhaustive list of applications for which particular attention must be given: (i) Outdoor use, uses involving potential chemical contamination or electrical interference, or conditions or uses not described in this document. (ii) Use in consumer products or any use in significant quantities. (iii) Energy control systems, combustion systems, railroad systems, aviation systems, medical equipment, amusement machines, vehicles, safety equipment, and installations subject to separate industry or government regulations. (iv) Systems, machines and equipment that could present a risk to life or property. Please know and observe all prohibitions of use applicable to this Product. NEVER USE THE PRODUCT FOR AN APPLICATION INVOLVING SERIOUS RISK TO LIFE OR PROPERTY OR IN LARGE QUANTITIES WITHOUT ENSURING THAT THE SYSTEM AS A WHOLE HAS BEEN DESIGNED TO ADDRESS THE RISKS, AND THAT THE OMRON'S PRODUCT IS PROPERLY RATED AND INSTALLED FOR THE INTENDED USE WITHIN THE OVERALL EQUIPMENT OR SYSTEM.
2. **Programmable Products.** Omron Companies shall not be responsible for the user's programming of a programmable Product, or any consequence thereof.
3. **Performance Data.** Data presented in Omron Company websites, catalogs and other materials is provided as a guide for the user in determining suitability and does not constitute a warranty. It may represent the result of Omron's test conditions, and the user must correlate it to actual application requirements. Actual performance is subject to the Omron's Warranty and Limitations of Liability.
4. **Change in Specifications.** Product specifications and accessories may be changed at any time based on improvements and other reasons. It is our practice to change part numbers when published ratings or features are changed, or when significant construction changes are made. However, some specifications of the Product may be changed without any notice. When in doubt, special part numbers may be assigned to fix or establish key specifications for your application. Please consult with your Omron's representative at any time to confirm actual specifications of purchased Product.
5. **Errors and Omissions.** Information presented by Omron Companies has been checked and is believed to be accurate; however, no responsibility is assumed for clerical, typographical or proofreading errors or omissions.

## **Notice:**

OMRON products are manufactured for use according to proper procedures by a qualified operator and only for the purposes described in this manual.

The following conventions are used to indicate and classify precautions in this manual. Always heed the information provided with them. Failure to heed precautions can result in injury to people or damage to property.



### **DANGER**

Indicates an imminently hazardous situation which, if not avoided, will result in death or serious injury.



### **WARNING**

Indicates a potentially hazardous situation which, if not avoided, could result in death or serious injury.



### **Caution**

Indicates a potentially hazardous situation which, if not avoided, may result in minor or moderate injury, or property damage.

## **OMRON Product References**

All OMRON products are capitalized in this manual. The word “Unit” is also capitalized when it refers to an OMRON product, regardless of whether or not it appears in the proper name of the product.

The abbreviation “Ch,” which appears in some displays and on some OMRON products, often means “word” and is abbreviated “Wd” in documentation in this sense.

The abbreviation “PC” means Programmable Controller and is not used as an abbreviation for anything else.

## **Visual Aids**

The following headings appear in the left column of the manual to help you locate different types of information.

**Note** Indicates information of particular interest for efficient and convenient operation of the product.

**1, 2, 3...** 1. Indicates lists of one sort or another, such as procedures, checklists, etc.

## **© OMRON, 1999**

All rights reserved. No part of this publication may be reproduced, stored in a retrieval system, or transmitted, in any form, or by any means, mechanical, electronic, photocopying, recording, or otherwise, without the prior written permission of OMRON.

No patent liability is assumed with respect to the use of the information contained herein. Moreover, because OMRON is constantly striving to improve its high-quality products, the information contained in this manual is subject to change without notice. Every precaution has been taken in the preparation of this manual. Nevertheless, OMRON assumes no responsibility for errors or omissions. Neither is any liability assumed for damages resulting from the use of the information contained in this publication.



# TABLE OF CONTENTS

<b>PRECAUTIONS</b> .....	<b>xi</b>
1 Intended Audience .....	xii
2 General Precautions .....	xii
3 Safety Precautions .....	xii
4 Operating Environment Precautions .....	xiii
5 Application Precautions .....	xiii
6 Conformance to EC Directives .....	xv
<b>SECTION 1</b>	
<b>Introduction</b> .....	<b>1</b>
1-1 Control Systems .....	2
1-2 The Role of the PC .....	2
1-3 PC Operation .....	4
1-4 CV-series Manuals .....	5
1-5 Features .....	6
1-6 Networks and Remote I/O Systems .....	9
1-7 Compatibility with CVM1, C-series, and CV-series Units .....	12
1-8 Related Manuals .....	13
<b>SECTION 2</b>	
<b>System Configuration and Components</b> .....	<b>15</b>
2-1 System Configuration .....	16
2-2 Unit Mounting Limitations .....	23
2-3 Racks .....	26
2-4 Rack Components .....	31
<b>SECTION 3</b>	
<b>Installation</b> .....	<b>47</b>
3-1 Assembly .....	48
3-2 Installation Environment .....	51
3-3 Installation .....	52
3-4 Rack Connections .....	55
3-5 CPU and I/O Connecting Cables .....	56
3-6 Power Supply Unit Wiring .....	57
3-7 Wiring I/O Units .....	72
3-8 Compliance with EC Directives .....	78
<b>SECTION 4</b>	
<b>System Startup and Trial Operation</b> .....	<b>81</b>
4-1 System Startup Preparations .....	82
4-2 Duplex System Startup .....	84
4-3 Startup of the Simplex System .....	87
4-4 Preparations for Trial Operation .....	89
<b>SECTION 5</b>	
<b>Inspection and Maintenance</b> .....	<b>95</b>
5-1 Consumable Parts .....	96
5-2 Inspections .....	96
5-3 I/O Unit Online Replacement .....	97
5-4 Replacing a CPU Unit .....	103
5-5 Replacing a Power Supply Unit .....	108



# TABLE OF CONTENTS

<b>SECTION 6</b>	
<b>Troubleshooting</b> .....	<b>111</b>
6-1 Troubleshooting Procedure .....	112
6-2 Error Indicators .....	113
6-3 Error Messages and Alarm Outputs .....	114
6-4 Troubleshooting Flowcharts .....	117
6-5 Error Processing and Correction .....	121
<b>Appendices</b>	
A Standard Models .....	123
B Specifications .....	135
<b>Glossary</b> .....	<b>177</b>
<b>Index</b> .....	<b>193</b>
<b>Revision History</b> .....	<b>197</b>

## About this Manual:

This manual describes the hardware and installation of the CVM1D Duplex System Programmable Controllers and includes the sections described below.

Please read this and all related manuals carefully and be sure you understand the information provided before attempting to operate or program a CVM1D Duplex System Programmable Controller. The main manuals required for operation are listed below. A list of other related manuals is provided at the end of *Section 1 Introduction*.

Manual	Contents	Cat. No.
CVM1D Duplex System PC Installation Guide	Describes the system configuration, specifications, installation, and wiring.	W350
CVM1D Duplex System PC Operation Manual	Describes ladder-diagram programming and programming instructions.	W351
CVM1-PRS21-V1E Programming Console Operation Manual	Describes Programming Console operations.	W222
CVM1/CV-series PCs Operation Manual: Host Link	Describes communications methods with host computers.	W205

**Section 1** provides general information about Programmable Controllers and how they fit into a Control System. It also lists the C-series, CVM1, and CV-series products that can be used with the CVM1D PCs and operation manuals available for various OMRON products. Finally, this section introduces Systems that can be used to create networks and enable remote I/O, and provides a list of manuals for related products

**Section 2** provides information about the types of system configuration in which the CVM1D PCs can be used and the individual Units that make up these configuration. Refer to Appendix A Standard Models for a list of OMRON products that can be used in CVM1D PC Systems.

**Section 3** describes how to assemble, mount, and wire a PC starting with a Backplane and use all the Units discussed in the previous section. Technical specifications and dimensions are provided in Appendix B Specifications.

**Section 4** describes procedures for the starting up the system and performing trial operation.

**Section 5** describes the procedures necessary for periodic inspection and maintenance.

**Section 6** describes the self-diagnostic functions of the PC and provides troubleshooting techniques and error corrections.

The **Appendices** provide a list of standard product model numbers and specifications.



**WARNING** Failure to read and understand the information provided in this manual may result in personal injury or death, damage to the product, or product failure. Please read each section in its entirety and be sure you understand the information provided in the section and related sections before attempting any of the procedures or operations given.



# PRECAUTIONS

This section provides general precautions for using the Programmable Controller (PC) and related devices.

**The information contained in this section is important for the safe and reliable application of the Programmable Controller. You must read this section and understand the information contained before attempting to set up or operate a PC system.**

1 Intended Audience .....	xii
2 General Precautions .....	xii
3 Safety Precautions .....	xii
4 Operating Environment Precautions .....	xiii
5 Application Precautions .....	xiii
6 Conformance to EC Directives .....	xv

## 1 Intended Audience

This manual is intended for the following personnel, who must also have knowledge of electrical systems (an electrical engineer or the equivalent).

- Personnel in charge of installing FA systems.
- Personnel in charge of designing FA systems.
- Personnel in charge of managing FA systems and facilities.

## 2 General Precautions

The user must operate the product according to the performance specifications described in the operation manuals.





Before using the product under conditions which are not described in the manual or applying the product to nuclear control systems, railroad systems, aviation systems, vehicles, combustion systems, medical equipment, amusement machines, safety equipment, and other systems, machines, and equipment that may have a serious influence on lives and property if used improperly, consult your OMRON representative.

Make sure that the ratings and performance characteristics of the product are sufficient for the systems, machines, and equipment, and be sure to provide the systems, machines, and equipment with double safety mechanisms.

This manual provides information for programming and operating the Unit. Be sure to read this manual before attempting to use the Unit and keep this manual close at hand for reference during operation.

-  **WARNING** It is extremely important that a PC and all PC Units be used for the specified purpose and under the specified conditions, especially in applications that can directly or indirectly affect human life. You must consult with your OMRON representative before applying a PC System to the above-mentioned applications.

## 3 Safety Precautions

-  **WARNING** Do not attempt to take any Unit apart while the power is being supplied. Doing so may result in electric shock.
-  **WARNING** Do not touch any of the terminals while the power is being supplied. Doing so may result in electric shock.
-  **WARNING** Do not attempt to disassemble, repair, or modify any Units. Any attempt to do so may result in malfunction, fire, or electric shock.
-  **WARNING** There is a lithium battery built into the SRAM Memory Cards. Do not short the positive and negative terminals of the battery, charge the battery, attempt to take it apart, subject it to pressures that would deform it, incinerate it, or otherwise mistreat it. Doing any of these could cause the battery to erupt, ignite, or leak.
-  **WARNING** Provide safety measures in external circuits (i.e., not in the Programmable Controller), including the following items, in order to ensure safety in the system if an abnormality occurs due to malfunction of the PC or another external factor affecting the PC operation. Not doing so may result in serious accidents.

- Emergency stop circuits, interlock circuits, limit circuits, and similar safety measures must be provided in external control circuits.
- The PC will turn OFF all outputs when its self-diagnosis function detects any error or when a severe failure alarm (FALS) instruction is executed. As a countermeasure for such errors, external safety measures must be provided to ensure safety in the system.
- The PC outputs may remain ON or OFF due to deposition or burning of the output relays or destruction of the output transistors. As a countermeasure for such problems, external safety measures must be provided to ensure safety in the system.
- When the 24-VDC output (service power supply to the PC) is overloaded or short-circuited, the voltage may drop and result in the outputs being turned OFF. As a countermeasure for such problems, external safety measures must be provided to ensure safety in the system.

 **Caution** Tighten the screws on the terminal block of the AC Power Supply Unit to the torque specified in the operation manual. The loose screws may result in burning or malfunction.

## 4 Operating Environment Precautions

 **Caution** Do not operate the control system in the following places:

- Locations subject to direct sunlight.
- Locations subject to temperatures or humidity outside the range specified in the specifications.
- Locations subject to condensation as the result of severe changes in temperature.
- Locations subject to corrosive or flammable gases.
- Locations subject to dust (especially iron dust) or salts.
- Locations subject to exposure to water, oil, or chemicals.
- Locations subject to shock or vibration.

 **Caution** Take appropriate and sufficient countermeasures when installing systems in the following locations:

- Locations subject to static electricity or other forms of noise.
- Locations subject to strong electromagnetic fields.
- Locations subject to possible exposure to radioactivity.
- Locations close to power supplies.

 **Caution** The operating environment of the PC System can have a large effect on the longevity and reliability of the system. Improper operating environments can lead to malfunction, failure, and other unforeseeable problems with the PC System. Be sure that the operating environment is within the specified conditions at installation and remains within the specified conditions during the life of the system.

## 5 Application Precautions

Observe the following precautions when using the PC System.

 **WARNING** Always heed these precautions. Failure to abide by the following precautions could lead to serious or possibly fatal injury.

- Always ground the system to 100  $\Omega$  or less when installing the Units to protect against electric shock.

- Always turn OFF the power supply to the PC before attempting any of the following. Not turning OFF the power supply may result in malfunction or electric shock.
  - Mounting or dismounting Power Supply Units, I/O Units, CPU Units, Memory Cassettes, or any other Units.
  - Assembling the Units.
  - Setting DIP switches or rotary switches.
  - Connecting or wiring the cables.
  - Connecting or disconnecting the connectors.

**Caution**

Failure to abide by the following precautions could lead to faulty operation of the PC or the system, or could damage the PC or PC Units. Always heed these precautions.

- Fail-safe measures must be taken by the customer to ensure safety in the event of incorrect, missing, or abnormal signals caused by broken signal lines, momentary power interruptions, or other causes.
- Interlock circuits, limit circuits, and similar safety measures in external circuits (i.e., not in the Programmable Controller) must be provided by the customer.
- Always use the power supply voltage specified in the operation manuals. An incorrect voltage may result in malfunction or burning.
- Take appropriate measures to ensure that the specified power with the rated voltage and frequency is supplied. Be particularly careful in places where the power supply is unstable. An incorrect power supply may result in malfunction.
- Install external breakers and take other safety measures against short-circuiting in external wiring. Insufficient safety measures against short-circuiting may result in burning.
- Do not mount a CVM1D Power Supply Unit in a CVM1 or CV-series PC. Doing so may result in burning or malfunction.
- Do not mount a CVM1 or CV-series Power Supply Unit on a Duplex CVM1D PC. Doing so may result in unexpected stoppage of the PC.
- Do not apply voltages to the Input Units in excess of the rated input voltage. Excess voltages may result in burning.
- Do not apply voltages or connect loads to the Output Units in excess of the maximum switching capacity. Excess voltage or loads may result in burning.
- Disconnect the functional ground terminal when performing withstand voltage tests. Not disconnecting the functional ground terminal may result in burning.
- Install the Unit properly as specified in the operation manual. Improper installation of the Unit may result in malfunction.
- Be sure that all the mounting screws, terminal screws, and cable connector screws are tightened to the torque specified in the relevant manuals. Incorrect tightening torque may result in malfunction.
- Leave the label attached to the Unit when wiring. Removing the label may result in malfunction.
- Remove the label after the completion of wiring to ensure proper heat dissipation. Leaving the label attached may result in malfunction.
- Use crimp terminals for wiring. Do not connect bare stranded wires directly to terminals. Connection of bare stranded wires may result in burning.
- Double-check all the wiring before turning on the power supply. Incorrect wiring may result in burning.
- Mount the Unit only after checking the terminal block completely.
- Be sure that the terminal blocks, EM Units, expansion cables, and other items with locking devices are properly locked into place. Improper locking may result in malfunction.

- Check the user program for proper execution before actually running it on the Unit. Not checking the program may result in an unexpected operation.
- Confirm that no adverse effect will occur in the system before attempting any of the following. Not doing so may result in an unexpected operation.
  - Changing the operating mode of the PC.
  - Force-setting/force-resetting any bit in memory.
  - Changing the present value of any word or any set value in memory.
- Do not pull on the cables or bend the cables beyond their natural limit. Doing either of these may break the cables.
- Do not place objects on top of the cables. Doing so may break the cables.
- When replacing parts, be sure to confirm that the rating of a new part is correct. Not doing so may result in malfunction or burning.
- Before touching the Unit, be sure to first touch a grounded metallic object in order to discharge any static built-up. Not doing so may result in malfunction or damage.

## 6 Conformance to EC Directives

The CVM1D PCs conform to EMC and Low Voltage Directives as follows:

### **EMC Directives**

OMRON devices that comply with EC Directives also conform to the related EMC standards so that they can be more easily built into other devices or the overall machine. The actual products have been checked for conformity to EMC standards (see the following note). Whether the products conform to the standards in the system used by the customer, however, must be confirmed by the customer.

EMC-related performance of the OMRON devices that comply with EC Directives will vary depending on the configuration, wiring, and other conditions of the equipment or control panel on which the OMRON devices are installed. The customer must, therefore, perform the final check to confirm that devices and the overall machine conform to EMC standards.

**Note** Applicable EMC (Electromagnetic Compatibility) standards are as follows:

EMS (Electromagnetic Susceptibility): EN61131-2  
EMI (Electromagnetic Interference): EN50081-2  
(Radiated emission: 10-m regulations)

### **Low Voltage Directive**

Always ensure that devices operating at voltages of 50 to 1,000 VAC and 75 to 1,500 VDC meet the required safety standards for the PC (EN61131-2).

The CVM1D, CVM1, and CV-series PCs that comply with EC Directives must be installed as follows:

- 1, 2, 3...** 1. The CVM1D, CVM1, and CV-series PCs are designed for installation inside control panels. All PCs must be securely grounded within control panels.
2. Use reinforced insulation or double insulation for the DC power supplies used for the communications power supply and I/O power supplies.
3. The CVM1D, CVM1, and CV-series PCs that comply with EC Directives also conform to the Common Emission Standard (EN50081-2). Radiated emission characteristics (10-m regulations) may vary depending on the configuration of the control panel used, other devices connected to the control panel, wiring, and other conditions. You must therefore confirm that the overall machine or equipment complies with EC Directives.



Precautions Regarding Relay Output Switching:

Noise generated by the switching of relay outputs may exceed the standards of the Common Emission Standard (EN50081-2). In this case, take the necessary countermeasures to reduce the emissions, such as connecting a surge suppressor or shielding the PC. Some methods of reducing emissions are shown below.

Countermeasures are required when the load switching frequency of the overall PC exceeds 5 times/minute. Refer to *3-8 Conformance to EC Directives* for examples of circuits that can be used to reduce noise generated by switching.

# SECTION 1

## Introduction

This section provides general information about Programmable Controllers and how they fit into a Control System. It also lists the C-series, CVM1, and CV-series products that can be used with the CVM1D PCs and operation manuals available for various OMRON products. Finally, this section introduces Systems that can be used to create networks and enable remote I/O, and provides a list of manuals for related products.

1-1	Control Systems .....	2
1-2	The Role of the PC .....	2
1-2-1	Input Devices .....	3
1-2-2	Output Devices .....	3
1-3	PC Operation .....	4
1-4	CV-series Manuals .....	5
1-5	Features .....	6
1-5-1	Duplex System Operation .....	6
1-5-2	Duplex Unit .....	7
1-5-3	Power Supply Redundancy .....	8
1-5-4	CVM1D Limitations .....	8
1-6	Networks and Remote I/O Systems .....	9
1-7	Compatibility with CVM1, C-series, and CV-series Units .....	12
1-8	Related Manuals .....	13

## 1-1 Control Systems

A Control System is the electronic equipment needed to control a particular process. It may include everything from a process control computer, to the factory computer, down through the PCs, and then on down through the network to the I/O devices: control components like the switches, stepping motors, solenoids, and sensors which monitor and control mechanical operations.

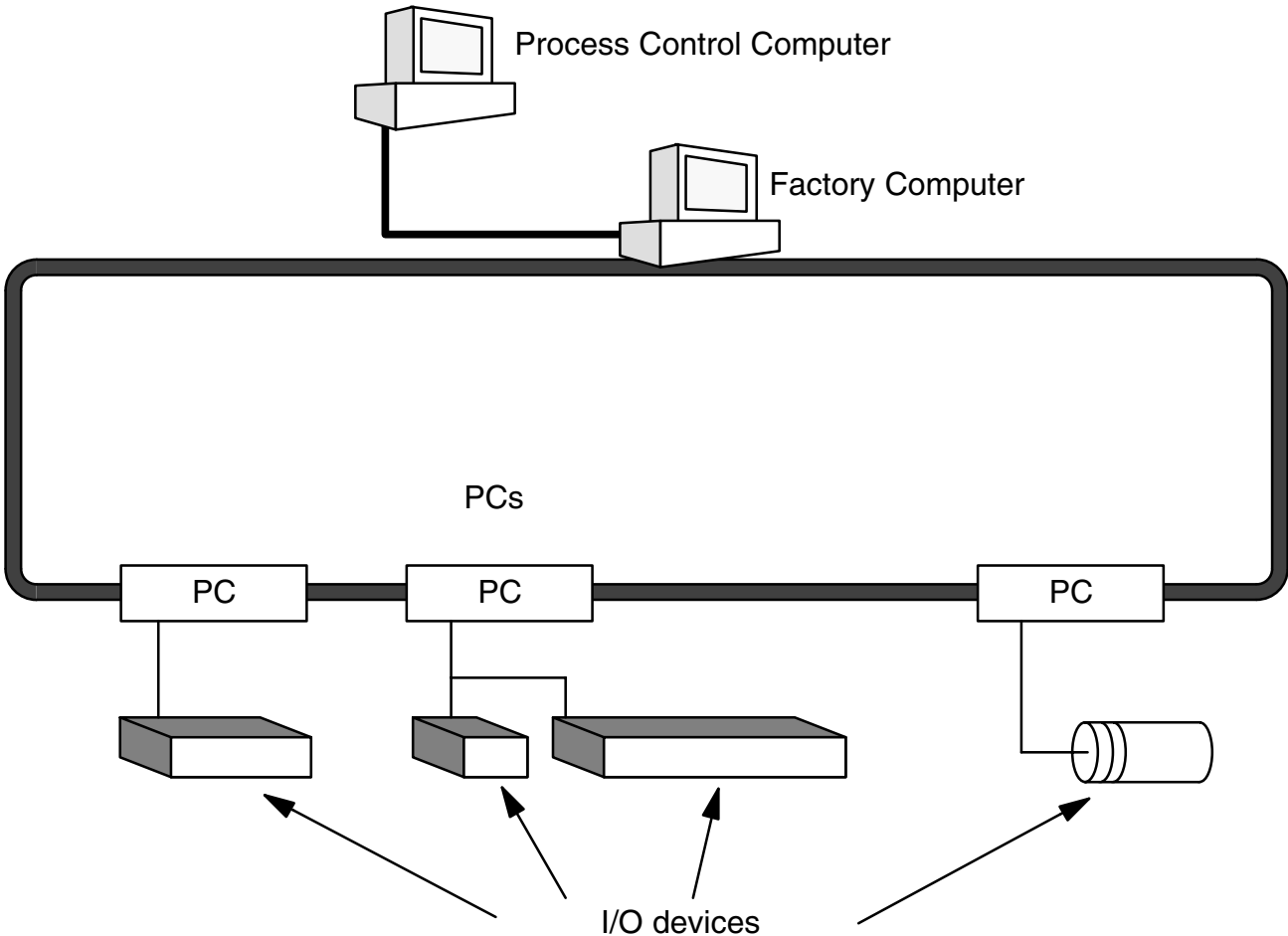

A Control System can involve very large applications where many different models of PC are networked together or it could be an application as small as a single PC controlling a number of output devices.

## 1-2 The Role of the PC

The PC is the part of the Control System that directly controls the manufacturing process. According to the program stored in its memory, the PC accepts data from the input devices connected to it and uses this data to monitor the controlled system. When the program calls for some action to take place, the PC sends data to the output devices connected to it to cause that action to take place. The PC may be used to control a simple, repetitive task, or it may be connected to other PCs or to a host computer in order to integrate the control of a complex process.

### 1-2-1 Input Devices

PCs can receive inputs from either automated or manual devices. The PC could receive data from the user via a pushbutton switch, keyboard, or similar device. Automated inputs could come from a variety of devices: micro-switches, timers, encoders, photoelectric sensors, and so on. Some devices, like the limit switch shown below, turn ON or OFF when the equipment actually makes contact with them. Other devices, like the photoelectric sensor and proximity sensor shown below, use other means, such as light or inductance, in order to get information about the equipment being monitored.

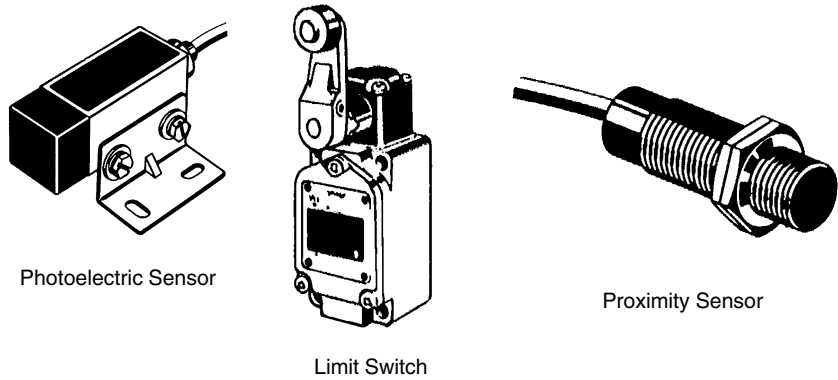

### 1-2-2 Output Devices

A PC can output to a myriad of devices for use in automated control. Almost anything that you can think of could be controlled by a PC. Some of the most common devices are motors, solenoids, servomotors, stepping motors, valves, switches, indicator lights, buzzers, and alarms. Some of these output devices, such as the motors, solenoids, servomotors, stepping motors, and valves, affect the controlled system directly. Others, such as the indicator lights, buzzers, and alarms, provide outputs to notify personnel operating or monitoring the system.

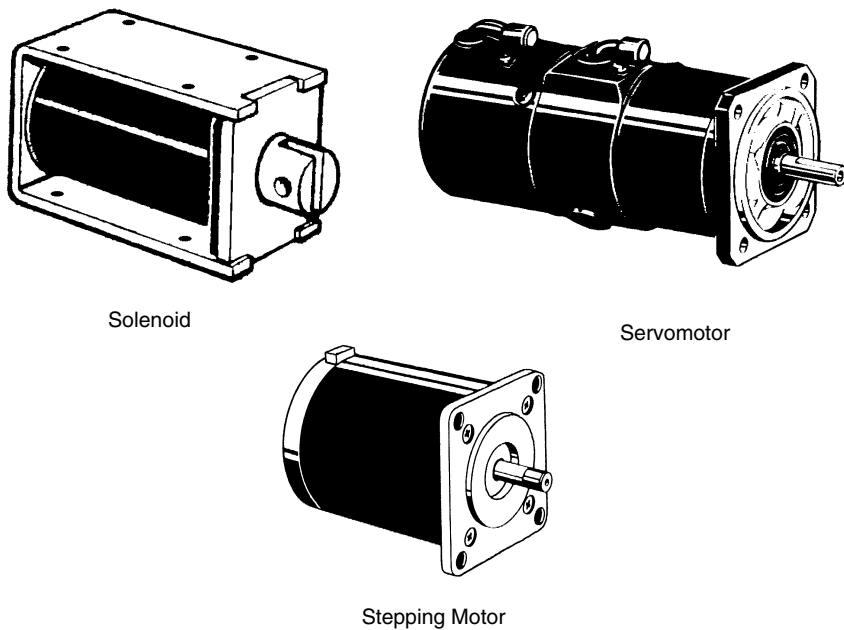

## 1-3 PC Operation

PCs operate by monitoring input signals and providing output signals. When changes are detected in input signals, the PC reacts through the user-programmed internal logic to produce output signals. The PC continually executes the program in its memory to achieve this control.

### Block Diagram of PC

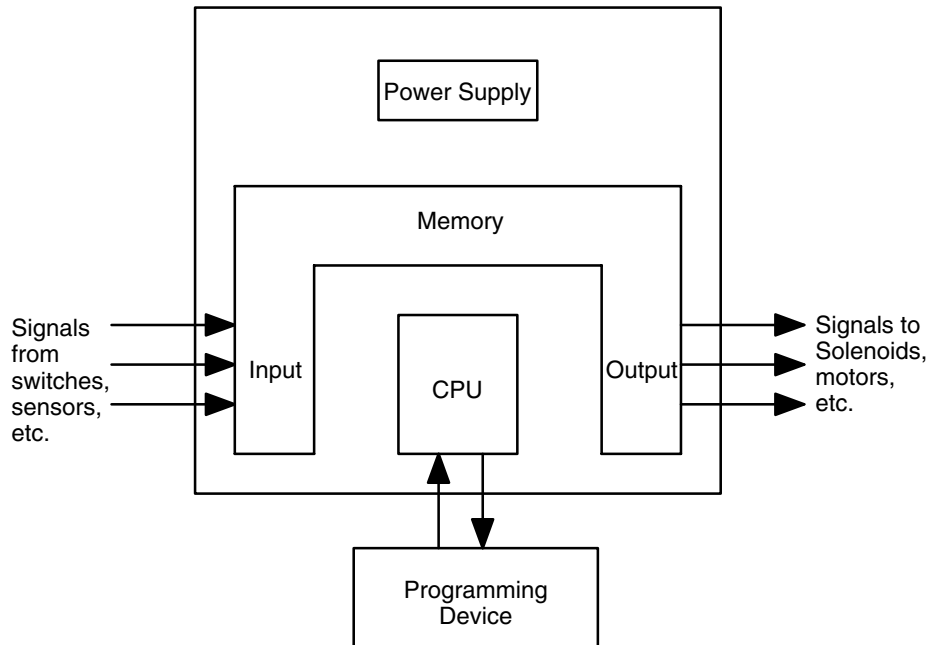

A program for your applications must be designed and stored in the PC. This program is then executed as part of the cycle of internal operations of the PC.

### Execution Cycle

When a PC operates, i.e., when it executes its program to control an external system, a series of operations are performed inside the PC. These internal operations can be broadly classified into the following four categories. Refer to the *CVM1D Operation Manual* for details.

- 1, 2, 3... 1. Common (or overseeing) processes, such as watchdog timer operation and testing the program memory.
2. Data input and output.
3. Program execution.
4. Programming Device servicing.

### Cycle Time

The total time required for a PC to perform all these internal operations is called the cycle time.

Timing is one of the most important factors in designing a Control System. For accurate operations, it is necessary to have answers to such questions as these:

- How long does it take for the PC to execute all the instructions in its memory?
- How long does it take for the PC to produce a control output in response to a given input signal?

The cycle time of the PC can be automatically calculated and monitored, but it is necessary to have an understanding of the timing relationships within the PC for effective System design and programming. Refer to the *CVM1D Operation Manual* for details on internal PC processing and to the *SSS Operation Manuals* for details on monitoring the cycle time.

## 1-4 CV-series Manuals

The following manuals are available for the various products that can be used in a CVM1D system. Catalog number suffixes have been omitted; be sure you have the most recent version for your region.

Product	Manual	Cat. No.
CV-series PCs	CV-series PCs Installation Guide	W195
	CV-series PCs Operation Manual: SFC	W194
	CV-series PCs Operation Manual: Ladder Diagrams	W202
	CV-series PCs Operation Manual: Host Link System, CV500-LK201 Host Link Unit	W205
SYSMAC Support Software (SSS)	SYSMAC Support Software Operation Manual: Basics	W247
	SYSMAC Support Software Operation Manual: CVM1 PCs	W249
Programming Console	CVM1-PRS21-E Programming Console Operation Manual	W222
SYSMAC NET Link System	SYSMAC NET Link System Manual	W213
SYSMAC LINK System	SYSMAC LINK System Manual	W212
SYSMAC BUS/2 Remote I/O System	SYSMAC BUS/2 Remote I/O System Manual	W204
CV-series Ethernet Unit	CV-series Ethernet System Manual	W242
BASIC Unit	BASIC Unit Reference Manual	W207
	BASIC Unit Operation Manual	W206
Personal Computer Unit	Personal Computer Unit Operation Manual	W251
	Personal Computer Unit Technical Manual	W252
Motion Control Unit	Motion Control Unit Operation Manual: Introduction	W254
	Motion Control Unit Operation Manual: Details	W255
Temperature Controller Data Link Unit	CV500-TDL21 Temperature Controller Data Link Unit	W244
Memory Card Writer	CV500-MCW01-E Memory Card Writer Operation Manual	W214
Optical Fiber Cable	Optical Fiber Cable Installation Guide	W156

## 1-5 Features

The SYSMAC CVM1D Duplex System is a high-speed, highly reliable ladder-program PC that can operate 24 hours/day.

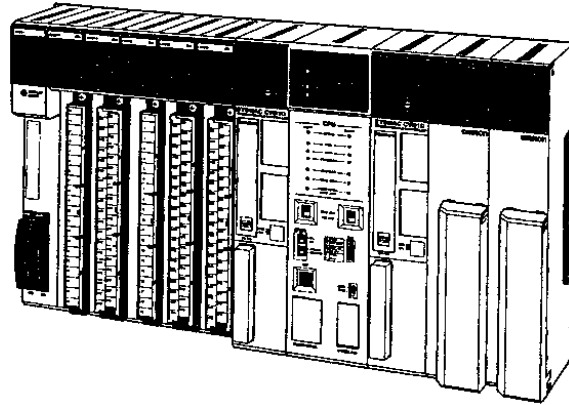

### Redundant CPU Units

The redundant CPU Units allow continuous, 24-hour/day PC operation. The CVM1D-CPU21 CPU Unit was developed specifically for the duplex system and based on the CVM1-CPU21-V2 CPU Unit, so the duplex CPU Unit inherits the superior performance of the CVM1 and CV-series PCs.

### Both Duplex and Simplex Operation are Supported

The PC can operate in duplex mode or simplex mode depending on the setting of the Duplex/Simplex Mode Switch on the front of the Duplex Unit.

### Redundant Power Supply Units

Redundant Power Supply Units have been added to CPU Racks, Expansion CPU Racks, and Expansion I/O Racks. The two Units supply power to the rack in parallel. Even if one of the Power Supply Units breaks down, the PC can continue operating normally and the faulty Unit can be replaced without interruption.

Backplanes that accommodate two Power Supply Units must be used for the Expansion CPU Racks and Expansion I/O Racks in order to take advantage of the redundant power supply function.

### Online I/O Unit Replacement

When an error occurs in an I/O Unit, the faulty Unit can be replaced without turning off the power to the whole system. Use the duplex system's CVM1-PRS21-EV1 Programming Console to replace an I/O Unit online.

### Compatible with C-series and CV-series Units

C500 I/O Units and Special I/O Units as well as CV-series CPU Bus Units can be used with CVM1D PCs.

## 1-5-1 Duplex System Operation

A CVM1D Duplex System can be assembled with redundant CPU Units and Power Supply Units to allow continuous operation.

### CVM1D Duplex System Configuration

A CVM1D can be configured to run in duplex mode with two CPU Units operating in parallel or in simplex mode with one CPU Unit operating independently.

- Duplex (DPL) System:  
Both CPU Units and Power Supply Units are redundant.
- Simplex (SPL) System:  
One CPU Unit is used, but Power Supply Units are redundant.

### Duplex (DPL) System

A CVM1D CPU Backplane is equipped with two CPU Units, a Duplex Unit, and two Power Supply Units.

When the PC is operating in duplex mode, the two CPU Units operate the same program and one CPU Unit (the active CPU Unit) controls the system while the other (the standby CPU Unit) operates in parallel. If an error occurs in the one of the CPU Units, operation continues with the other CPU Unit and the faulty CPU Unit can be replaced without stopping the PC.

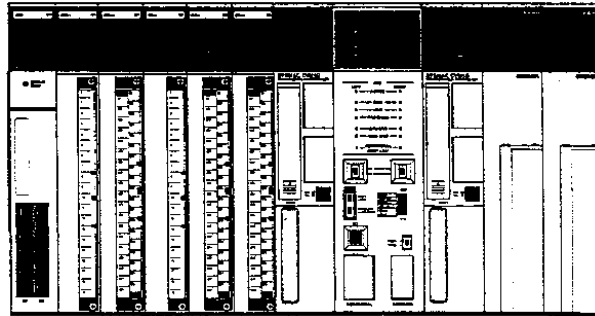

**Simplex (SPL) System**

A CVM1D CPU Backplane is equipped with a CPU Unit, a Duplex Unit, and two Power Supply Units.

The Duplex Unit is primarily needed to operate the duplex system, but it performs other functions such as I/O bus switching so the Duplex Unit is also required in a simplex system.

Two Power Supply Units are used, so the PC can continue operating with one Power Supply Unit if the other breaks down. The faulty Unit can be replaced without stopping operation.

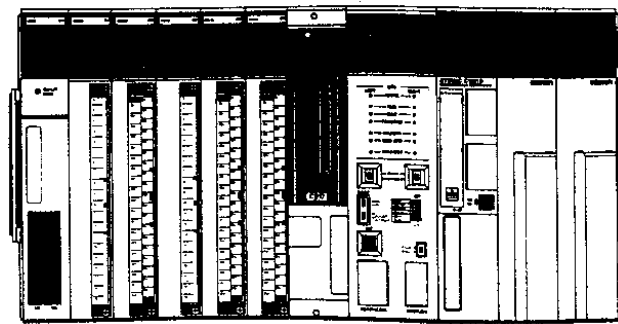

**1-5-2 Duplex Unit**

The Duplex Unit monitors errors in the two CPU Units and switches the CPU bus, I/O bus, and Peripheral bus to the standby CPU Unit if an error occurs in the active CPU Unit.

**Operation of the CVM1D Duplex System**

When the PC is operating as a duplex system, the two CPU Units perform different roles, one is the active CPU Unit and the other is the standby CPU Unit.

CPU Unit	Operation
Active CPU Unit	Executes the program and controls I/O Units, Special I/O Units, and CPU Bus Units.
Standby CPU Unit	Executes the same program as the active CPU Unit but does not control I/O.

- The “active CPU Unit” is determined at the start of duplex mode operation by the setting on the Duplex Unit’s Active CPU Switch.
- If an error occurs in the active CPU Unit during operation, operation is switched automatically to the standby CPU Unit which becomes the active CPU Unit.
- The PC can be returned to duplex mode operation by replacing or repairing the CPU Unit in which the error occurred.



### 1-5-3 Power Supply Redundancy

When two Power Supply Units are mounted, the Backplane's 5-VDC power is supplied simultaneously from the two Power Supply Units.

If one of the Power Supply Units breaks down, its load will be picked up by the other Power Supply Unit. Be sure that the current consumption of all of the Units mounted in the Backplane can be supplied by either one of the Power Supply Units. If one of the Power Supply Units breaks down and the capacity of the other Unit is insufficient, the second Unit will overload and the system will shutdown.

The Power Supply Units' error status is displayed on Rack's I/O Control Unit or I/O Interface Unit (ICererer/IIererer). The error status is also indicated in the Power Supply Unit OFF/Error Flags in A397 and A398.

### 1-5-4 CVM1D Limitations

The performance of CVM1D CPU Units is comparable to that of the CVM1-CPU-EV1, but as part of the conversion to duplex operation several instructions have been removed and some Units have become incompatible.

#### Incompatible Units

- C2000-ID216 Interrupt Input Unit  
(If the Unit is mounted, it will operate as a normal 8-point Input Unit.)
- C500-ASC03 ASCII Unit

#### Unusable Instructions

Refer to the *CVM1D Operation Manual* for more details on the following instructions.

- Immediate-refresh Variations  
(Immediate-refreshing variations can be used in simplex mode, but they can cause improper operation in duplex mode so they should not be used.)
- Interrupt Control Instructions  
MSKS(153), CLI(154), and MSKR(155)
- Memory Card instructions  
FILR(180), FILW(181), FILP(182), and FLSP(183)

#### Memory Card Functions

Memory Cards can be installed and used in each CPU Unit, although the Card's program and data are not included in duplex synchronization.

#### I/O Refreshing

Cyclic refreshing is the only method used to refresh the entire I/O area. The I/O REFRESH instruction (IORF(184)) can be used to refresh specific ranges of I/O words. Immediate refreshing cannot be used in duplex mode.

#### Operation of Timers

The precision of the TIM, TIMH(015), and TTIM(120) timers has decreased slightly because of changes in the refreshing process. Refer to the *CVM1D Operation Manual* for more details on the precision of timers.

# 1-6 Networks and Remote I/O Systems

The following diagram shows the communications networks that can be used with the CVM1D PCs.

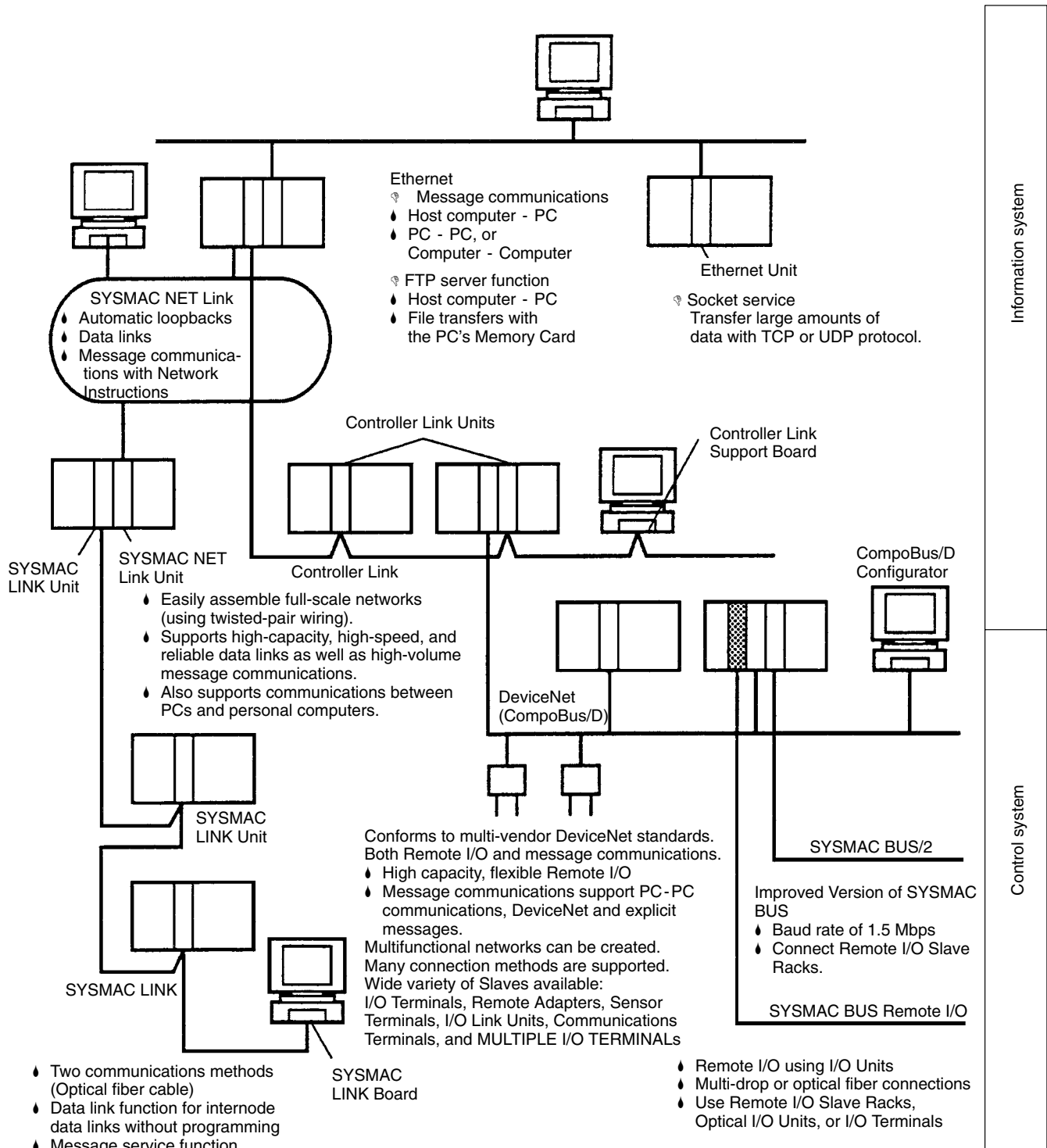

## Ethernet

Mounting an Ethernet Unit allows message (FINS) communications between the PC and other PCs or host computers on the Ethernet. It is also possible to transfer data to and from the Memory Card installed in the CPU Unit by issuing an FTP command to the PC from a host computer on the Ethernet. In addition, all kinds of data can be transferred by UDP or TCP protocol.