



Chipsmall Limited consists of a professional team with an average of over 10 year of expertise in the distribution of electronic components. Based in Hongkong, we have already established firm and mutual-benefit business relationships with customers from,Europe,America and south Asia,supplying obsolete and hard-to-find components to meet their specific needs.

With the principle of “Quality Parts,Customers Priority,Honest Operation,and Considerate Service”,our business mainly focus on the distribution of electronic components. Line cards we deal with include Microchip,ALPS,ROHM,Xilinx,Pulse,ON,Everlight and Freescale. Main products comprise IC,Modules,Potentiometer,IC Socket,Relay,Connector.Our parts cover such applications as commercial,industrial, and automotives areas.

We are looking forward to setting up business relationship with you and hope to provide you with the best service and solution. Let us make a better world for our industry!



Contact us

Tel: +86-755-8981 8866 Fax: +86-755-8427 6832

Email & Skype: info@chipsmall.com Web: www.chipsmall.com

Address: A1208, Overseas Decoration Building, #122 Zhenhua RD., Futian, Shenzhen, China



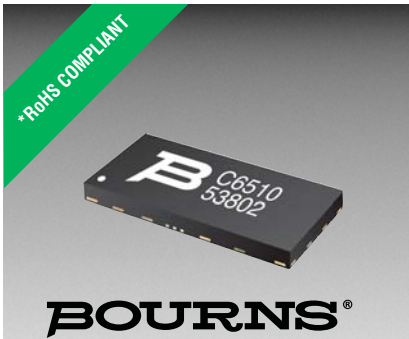

Features

- Formerly **FulTec** brand
- Extremely high speed performance
- Blocks high voltages and currents
- Very high bandwidth; GHz compatible
- Small package, minimal PCB area
- Simple, superior circuit protection
- RoHS compliant*, UL Recognized



The C650 & C850 Series are currently available, but not recommended for new designs. Bourns® TBU-CA Series is preferred.

C650 and C850 Series TBU® High-Speed Protectors

Transient Blocking Units - TBU® Devices

Bourns® C650 and C850 series products are high-speed bidirectional protection components, constructed using MOSFET semiconductor technology, designed to protect against faults caused by short circuits, AC power cross, induction and lightning surges.

The TBU® high-speed protector, triggering as a function of the MOSFET, blocks surges and provides an effective barrier behind which sensitive electronics are not exposed to large voltages or currents during surge events. The TBU® device is provided in a surface mount DFN package and meets industry standard requirements such as RoHS and Pb Free solder reflow profiles.

Agency Approval

UL recognized component File # E315805.

Industry Standards

| Description | | | Model |
|-------------|--------------------------------|-------------------|--------------|
| Telcordia | GR-1089 | Port Type 1, 3, 5 | C650 C850 |
| | GR-974 | | C650 C850 |
| ITU-T | K.20, K.20E, K.21, K.21E, K.45 | | C850 |

Absolute Maximum Ratings (T_{amb} = 25 °C)

| Symbol | Parameter | | Value | Unit |
|------------------|---|-------------|-------------|------|
| V _{imp} | Maximum protection voltage for impulse faults with rise time ≥ 1 μsec | C650-xxx-WH | 650 | V |
| | | C850-xxx-WH | 850 | |
| V _{rms} | Maximum protection voltage for continuous V _{rms} faults | C650-xxx-WH | 300 | V |
| | | C850-xxx-WH | 425 | |
| T _{op} | Operating temperature range | | -40 to +85 | °C |
| T _{stg} | Storage temperature range | | -65 to +150 | °C |

Electrical Characteristics (T_{amb} = 25 °C)

| Symbol | Parameter | | Min. | Typ. | Max. | Unit |
|------------------------|---|--|------|--------------------------------|------------------------------------|------|
| I _{op} | Maximum current through the device that will not cause current blocking | Cx50-100-WH Cx50-180-WH Cx50-260-WH | | | 100 180 260 | mA |
| I _{trigger} | Typical current for the device to go from normal operating state to protected state | Cx50-100-WH Cx50-180-WH Cx50-260-WH | | 150 220 330 | | mA |
| I _{out} | Maximum current through the device | Cx50-100-WH Cx50-180-WH Cx50-260-WH | | | 200 360 520 | mA |
| R _{device} | Series resistance of the TBU® device | C650-100-WH C650-180-WH C650-260-WH C850-100-WH C850-180-WH C850-260-WH | | 12 8 8 17 11 11 | 14.5 10 10 19 14 14 | Ω |
| t _{block} | Maximum time for the device to go from normal operating state to protected state | | | | 1 | μs |
| I _{quiescent} | Current through the triggered TBU® device with 50 Vdc circuit voltage | | | 1 | | mA |
| V _{reset} | Voltage below which the triggered TBU® device will transition to normal operating state | | | 14 | | V |

C650 and C850 TBU® High-Speed Protectors are bidirectional; specifications are valid in both directions.

*RoHS Directive 2002/95/EC Jan. 27, 2003 including annex and RoHS Recast 2011/65/EU June 8, 2011. Specifications are subject to change without notice.

The device characteristics and parameters in this data sheet can and do vary in different applications and actual device performance may vary over time. Users should verify actual device performance in their specific applications.

Applications

- Combo voice / xDSL linecards
- Voice linecards
- MDF, primary protection modules
- Process control equipment
- Test and measurement equipment
- General electronics

C650 and C850 Series TBU® High-Speed Protectors

BOURNS®

Typical Performance Characteristics

V-I Characteristics

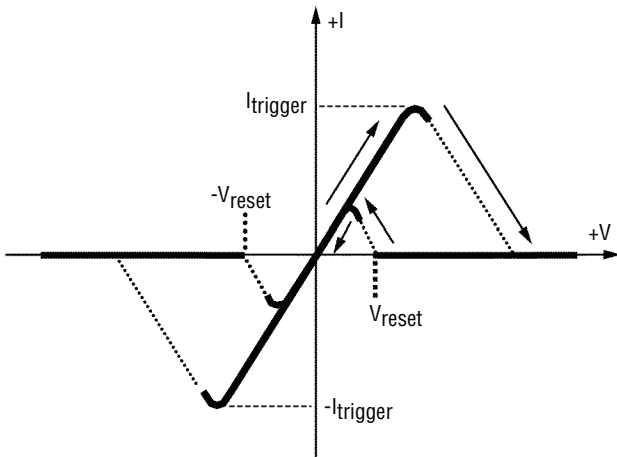

Time to Block vs. Fault Current

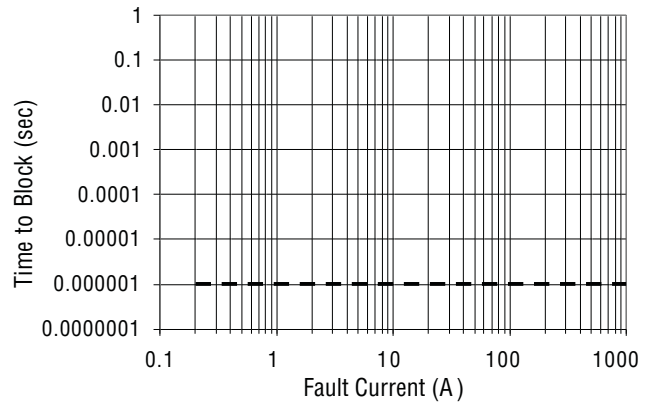

Current vs. Temperature

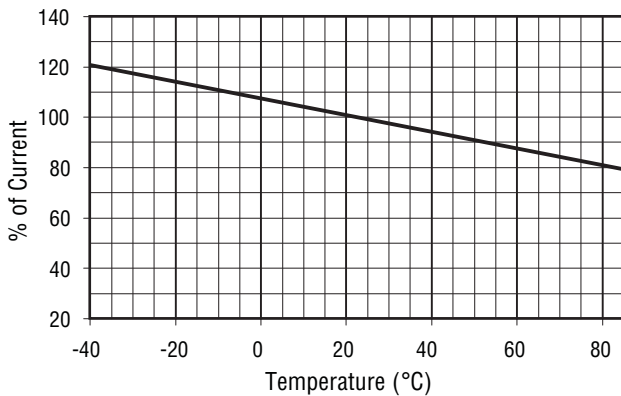

Specifications are subject to change without notice.
 The device characteristics and parameters in this data sheet can and do vary in different applications and actual device performance may vary over time.
 Users should verify actual device performance in their specific applications.

C650 and C850 Series TBU® High-Speed Protectors

BOURNS®

Operational Characteristics

The graphs below demonstrate the operational characteristics of the TBU® protector. For each graph the fault voltage, protected side voltage, and current is presented.

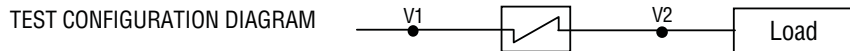

C650 Lightning, 650 V

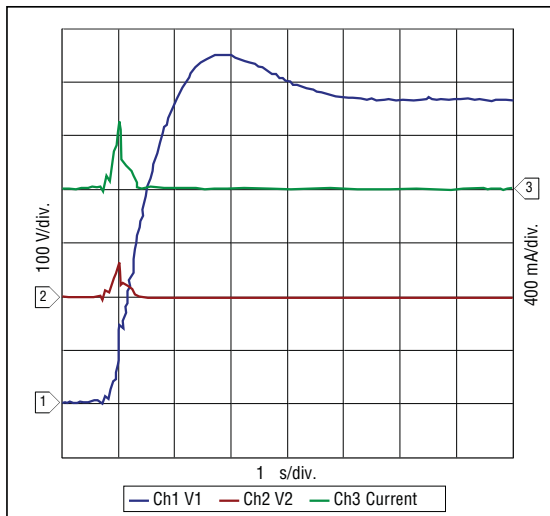

C850 Lightning, 850 V

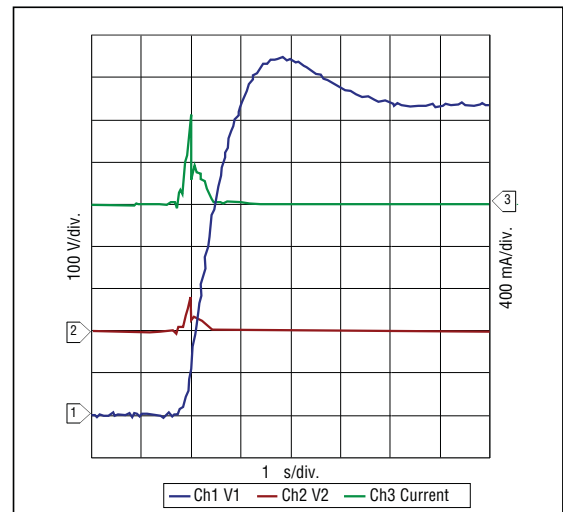

C650 Power Fault, 300 Vrms, 100 A

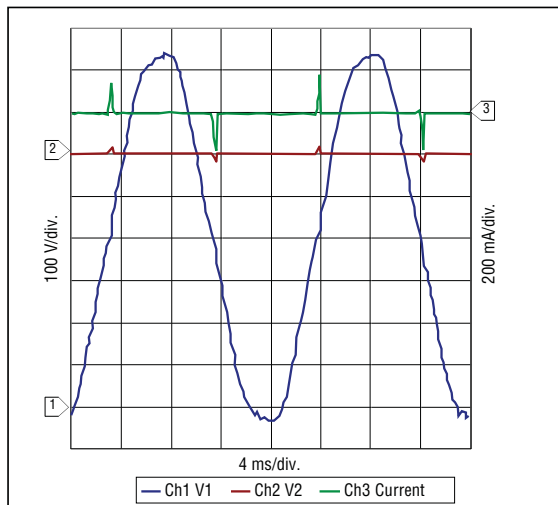

C850 Power Fault, 425 Vrms, 100 A

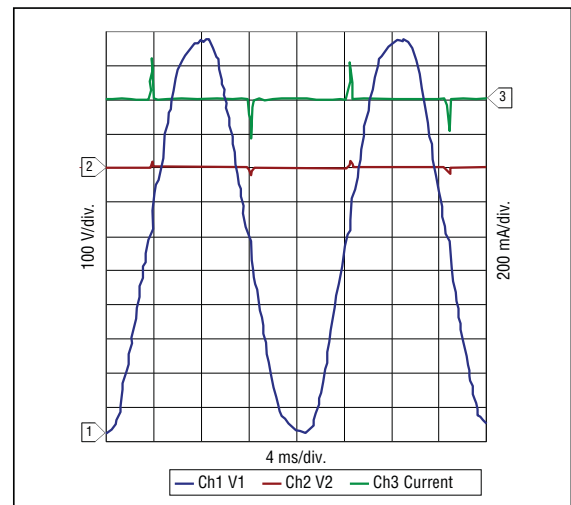

Specifications are subject to change without notice.
The device characteristics and parameters in this data sheet can and do vary in different applications and actual device performance may vary over time.
Users should verify actual device performance in their specific applications.

C650 and C850 Series TBU® High-Speed Protectors

BOURNS®

Product Dimensions

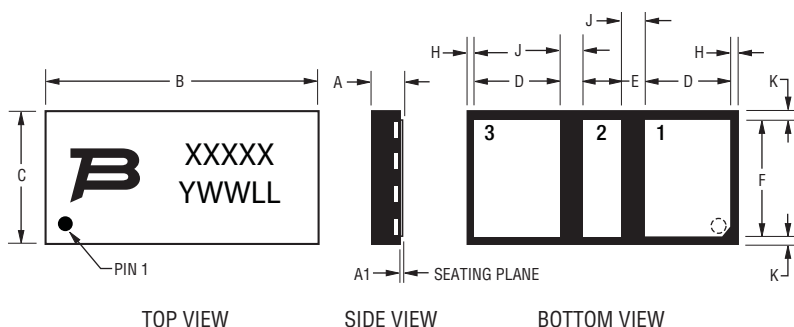

| Dim. | Min. | Typ. | Max. |
|------|----------------|-----------------|-----------------|
| A | 0.80 (.031) | 0.90 (.035) | 1.00 (.039) |
| A1 | 0.00 (.000) | 0.025 (.001) | 0.050 (.002) |
| B | 8.15 (.321) | 8.25 (.325) | 8.35 (.329) |
| C | 3.90 (.154) | 4.00 (.157) | 4.10 (.161) |
| D | 2.55 (.100) | 2.60 (.102) | 2.65 (.104) |
| E | 1.10 (.043) | 1.15 (.045) | 1.20 (.047) |
| F | 3.45 (.136) | 3.50 (.138) | 3.55 (.140) |
| H | 0.20 (.008) | 0.25 (.010) | 0.30 (.012) |
| J | 0.65 (.026) | 0.70 (.028) | 0.75 (.030) |
| K | 0.20 (.008) | 0.25 (.010) | 0.30 (.012) |

Recommended Pad Layout

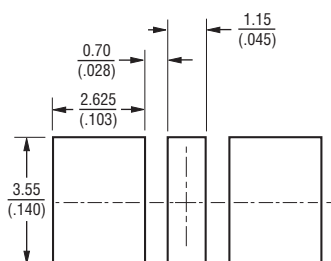

Pad Designation

| Pad # | Apply |
|-------|--------|
| 1 | In/Out |
| 2 | NC |
| 3 | In/Out |

NC = Solder to PCB; do not make electrical connection, do not connect to ground.

DIMENSIONS: $\frac{\text{MM}}{\text{(INCHES)}}$

TBU® protectors have matte-tin termination finish. Suggested layout should use non-solder mask define (NSMD). Recommended stencil thickness is 0.10-0.12 mm (.004-.005 in.) with stencil opening size 0.025 mm (.0010 in.) less than the device pad size. As when heat sinking any power device, it is recommended that, wherever possible, extra PCB copper area is allowed. For minimum parasitic capacitance, do not allow any signal, ground or power signals beneath any of the pads of the device.

Thermal Resistances

| Symbol | Parameter | Value | Unit |
|---------------|-----------------------------|-------|------|
| $R_{th(j-a)}$ | Junction to leads (package) | 116 | °C/W |

Reflow Profile

| Profile Feature | Pb-Free Assembly |
|---|------------------|
| Average Ramp-Up Rate (T _{smax} to T _p) | 3 °C/sec. max. |
| Preheat | |
| - Temperature Min. (T _{smin}) | 150 °C |
| - Temperature Max. (T _{smax}) | 200 °C |
| - Time (t _{smin} to t _{smax}) | 60-180 sec. |
| Time maintained above: | |
| - Temperature (T _L) | 217 °C |
| - Time (t _L) | 60-150 sec. |
| Peak/Classification Temperature (T _p) | 260 °C |
| Time within 5 °C of Actual Peak Temp. (t _p) | 20-40 sec. |
| Ramp-Down Rate | 6 °C/sec. max. |
| Time 25 °C to Peak Temperature | 8 min. max. |

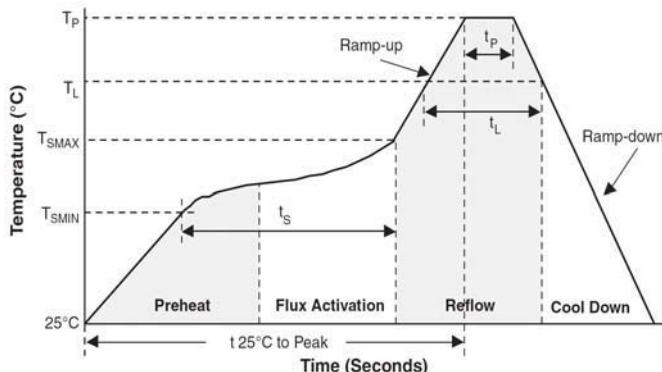

Specifications are subject to change without notice. The device characteristics and parameters in this data sheet can and do vary in different applications and actual device performance may vary over time. Users should verify actual device performance in their specific applications.

C650 and C850 Series TBU® High-Speed Protectors

BOURNS®

How to Order

C 650 - 180 - WH

Form Factor _____
 C = One TBU® protector in the device

Impulse Voltage Rating _____
 650 = 650 V
 850 = 850 V

lop Indicator _____
 100 = 100 mA
 180 = 180 mA
 260 = 260 mA

Typical Part Marking

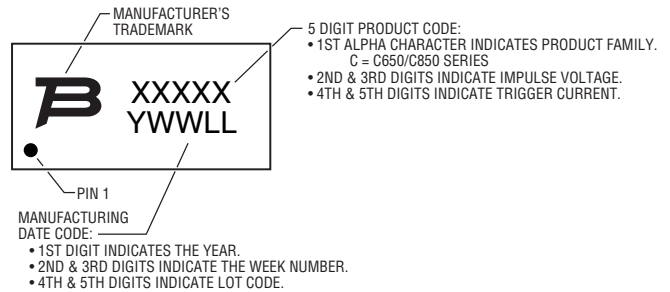

Packaging Specifications (per EIA468-B)

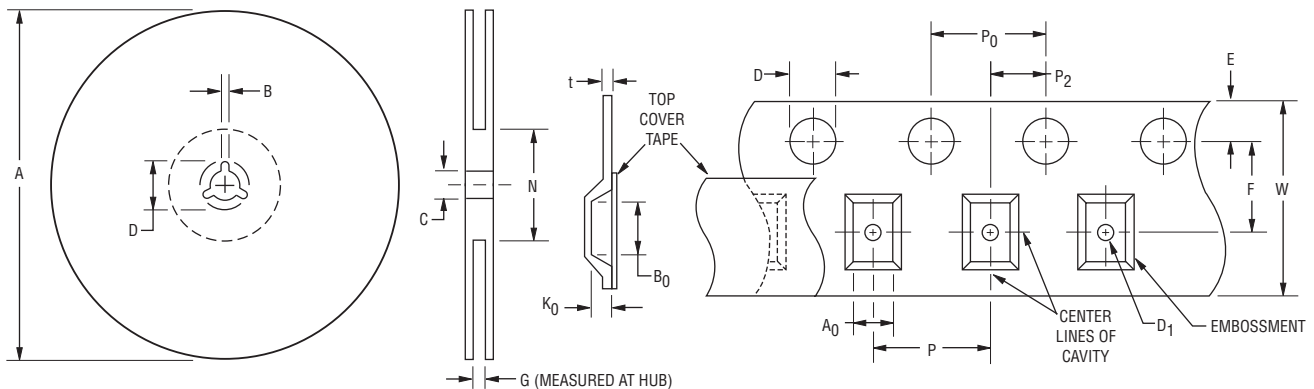

QUANTITY: 3000 PIECES PER REEL

| Device | A | | B | | C | | D | | G | N |
|------------|-------------------------|----------------------------|----------------------|----------------------|-----------------------|-----------------------|-----------------------|------|-----------------------|-----------------------|
| | Min. | Max. | Min. | Max. | Min. | Max. | Min. | Max. | Ref. | Ref. |
| C650, C850 | <u>326</u> (.12.835) | <u>330.25</u> (.13.002) | <u>1.5</u> (.059) | <u>2.5</u> (.098) | <u>12.8</u> (.504) | <u>13.5</u> (.531) | <u>20.2</u> (.795) | - | <u>16.5</u> (.650) | <u>102</u> (4.016) |

| Device | A0 | | B0 | | D | | D1 | | E | | F | |
|------------|----------------------|----------------------|-----------------------|-----------------------|----------------------|----------------------|----------------------|----------------------|-----------------------|-----------------------|-----------------------|-----------------------|
| | Min. | Max. | Min. | Max. | Min. | Max. | Min. | Max. | Min. | Max. | Min. | max. |
| C650, C850 | <u>4.2</u> (.165) | <u>4.4</u> (.173) | <u>8.45</u> (.333) | <u>8.65</u> (.341) | <u>1.5</u> (.059) | <u>1.6</u> (.063) | <u>1.5</u> (.059) | - | <u>1.65</u> (.065) | <u>1.85</u> (.073) | <u>7.4</u> (.291) | <u>7.6</u> (.299) |
| Device | K0 | | P | | P0 | | P2 | | t | | W | |
| | Min. | Max. | Min. | Max. | Min. | Max. | Min. | Max. | Min. | Max. | Min. | Max. |
| C650, C850 | <u>1.1</u> (.043) | <u>1.3</u> (.051) | <u>7.9</u> (.311) | <u>8.1</u> (.319) | <u>3.9</u> (.159) | <u>4.1</u> (.161) | <u>1.9</u> (.075) | <u>2.1</u> (.083) | <u>0.25</u> (.010) | <u>0.35</u> (.014) | <u>15.7</u> (.618) | <u>16.3</u> (.642) |

DIMENSIONS: $\frac{\text{MM}}{\text{(INCHES)}}$

Specifications are subject to change without notice.
 The device characteristics and parameters in this data sheet can and do vary in different applications and actual device performance may vary over time.
 Users should verify actual device performance in their specific applications.

Reference Application

The C-series devices are general protectors that can be used in a variety of applications. The basic operation of the device will be demonstrated using the single line application shown in the figure below. The test circuit was subjected to a 1000 V, 10/700 μ s surge waveform. The devices used were the TBU-C850-100-WH and a 2031-42T-SM-RPLF GDT (OVP) with a 10 ohm resistor for the load impedance.

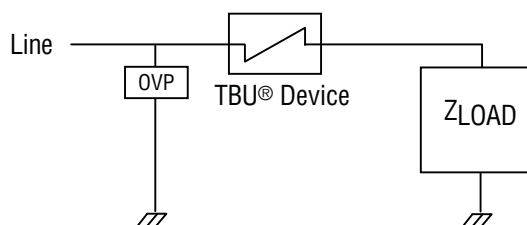

General Application Circuit

The graph below shows the waveforms for the voltage across the overvoltage protector (GDT) and the current through the TBU® device. As the input line voltage increases, the current through the TBU® device increases rapidly until the trip current is reached. Due to finite reaction time for fast transients, the peak level may exceed the low frequency data sheet maximum for a very short period, typically ~ 100 ns. After this initial overshoot, the TBU® device will transition to the protected state, setting the current to the nominal current limiting level (~ 150 mA for this example). The TBU® device will then reduce the current down to its very low quiescent level of 1 mA, typically. As the input line voltage increases to about 500 V, the GDT is triggered, reducing the input line voltage to a very low level which prevents the TBU® device from being subjected to a voltage level which exceeds its maximum rating (850 V in this example). The TBU® High-Speed Protector and the GDT will remain in these states until the surge ends, which is about 700 μ s later in this example. Only the first 4 μ s of the surge are shown in the graph. For surges or AC voltages below the GDT breakover voltage, the GDT will not activate, and the TBU® device will stay in the protecting mode, blocking high voltages from the protected equipment.

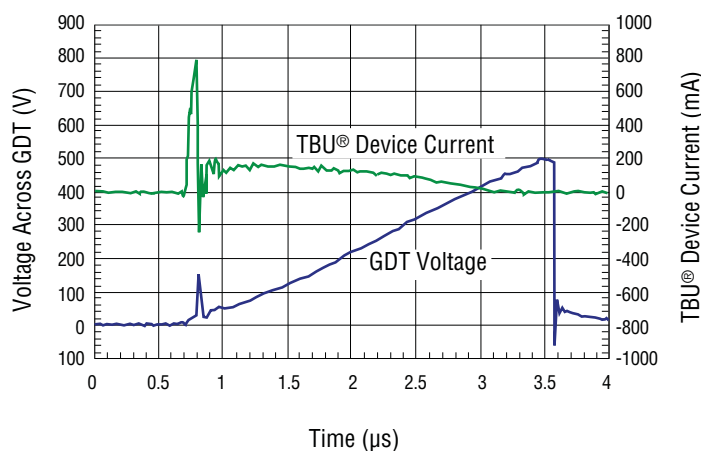

TBU-C850-100-WH Response to a 1000 V, 10/700 μ s Surge

REV. 09/15

"TBU" is a registered trademark of Bourns, Inc. in the United States and other countries.

Specifications are subject to change without notice.

The device characteristics and parameters in this data sheet can and do vary in different applications and actual device performance may vary over time. Users should verify actual device performance in their specific applications.