



Chipsmall Limited consists of a professional team with an average of over 10 year of expertise in the distribution of electronic components. Based in Hongkong, we have already established firm and mutual-benefit business relationships with customers from,Europe,America and south Asia,supplying obsolete and hard-to-find components to meet their specific needs.

With the principle of "Quality Parts,Customers Priority,Honest Operation,and Considerate Service",our business mainly focus on the distribution of electronic components. Line cards we deal with include Microchip,ALPS,ROHM,Xilinx,Pulse,ON,Everlight and Freescale. Main products comprise IC,Modules,Potentiometer,IC Socket,Relay,Connector.Our parts cover such applications as commercial,industrial, and automotives areas.

We are looking forward to setting up business relationship with you and hope to provide you with the best service and solution. Let us make a better world for our industry!



## Contact us

Tel: +86-755-8981 8866 Fax: +86-755-8427 6832

Email & Skype: info@chipsmall.com Web: www.chipsmall.com

Address: A1208, Overseas Decoration Building, #122 Zhenhua RD., Futian, Shenzhen, China



# Capacitor Array, X7R Dielectric, 10 – 200 VDC (Commercial & Automotive Grade)

## Overview

KEMET's Ceramic Chip Capacitor Array in X7R dielectric is an advanced passive technology where multiple capacitor elements are integrated into one common monolithic structure. Array technology promotes reduced placement costs and increased throughput. This is achieved by alternatively placing one device rather than two or four discrete devices. Use of capacitor arrays also saves board space which translates into increased board density and more functions per board. Arrays consume only a portion of the space required for standard chips resulting in savings in inventory and pick/place machine positions.

KEMET's X7R dielectric features a 125°C maximum operating temperature and is considered "temperature stable." The

Electronics Industries Alliance (EIA) characterizes X7R dielectric as a Class II material. Components of this classification are fixed, ceramic dielectric capacitors suited for bypass and decoupling applications or for frequency discriminating circuits where Q and stability of capacitance characteristics are not critical. X7R exhibits a predictable change in capacitance with respect to time and voltage and boasts a minimal change in capacitance with reference to ambient temperature. Capacitance change is limited to  $\pm 15\%$  from -55°C to +125°C.

KEMET automotive grade array capacitors meet the demanding Automotive Electronics Council's AEC-Q200 qualification requirements.

## Benefits

- -55°C to +125°C operating temperature range
- Saves both circuit board and inventory space
- Reduces placement costs and increases throughput
- RoHS Compliant
- EIA 0508 (2-element) and 0612 (4-element) case sizes
- DC voltage ratings of 10 V, 16 V, 25 V, 50 V, 100 V, and 200 V

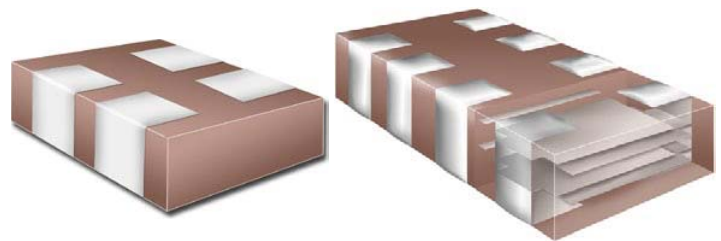

## Ordering Information

CA	06	4	C	104	K	4	R	A	C	TU
Ceramic Array	Case Size (L" x W") <sup>1</sup>	Number of Capacitors	Specification/ Series	Capacitance Code (pF)	Capacitance Tolerance	Voltage	Dielectric	Failure Rate/ Design	Termination Finish <sup>2</sup>	Packaging/Grade (C-Spec) <sup>3</sup>
	05 = 0508 06 = 0612	2 = 2 4 = 4	C = Standard X = Flexible Termination	2 Significant Digits + Number of Zeros	J = $\pm 5\%$ K = $\pm 10\%$ M = $\pm 20\%$	8 = 10 V 4 = 16 V 3 = 25 V 5 = 50 V 1 = 100 V 2 = 200 V	R = X7R	A = N/A	C = 100% Matte Sn L = SnPb (5% minimum)	Blank = Bulk TU = 7" Reel Unmarked TM = 7" Reel Marked AUTO = Automotive Grade

<sup>1</sup> All previous reference to metric case dimension "1632" has been replaced with an inch standard reference of "0612". Please reference all new designs using the "0612" nomenclature. "CA064" replaces "C1632" in the ordering code.

<sup>2</sup> Additional termination finish options may be available. Contact KEMET for details.

<sup>2,3</sup> SnPb termination finish option is not available on automotive grade product.

<sup>3</sup> Additional reeling or packaging options may be available. Contact KEMET for details.

## Dimensions – Millimeters (Inches)

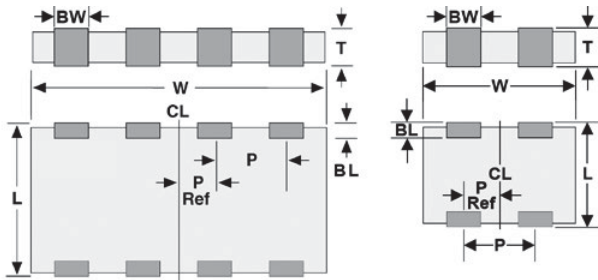

EIA Size Code	Metric Size Code	L Length	W Width	BW Bandwidth	BL Bandlength	T Thickness	P Pitch	P Reference
0508	1220	1.30 (0.051) ±0.15 (0.006)	2.10 (0.083) ±0.15 (0.006)	0.53 (0.021) ±0.08 (0.003)	0.30 (0.012) ±0.20 (0.008)	See Table 2 for Thickness	1.00 (0.039) ±0.10 (0.004)	0.50 (0.020) ±0.10 (0.004)
0612	1632	1.60 (0.063) ±0.20 (0.008)	3.20 (0.126) ±0.20 (0.008)	0.40 (0.016) ±0.20 (0.008)	0.30 (0.012) ±0.20 (0.008)		0.80 (0.031) ±0.10 (0.004)	0.40 (0.016) ±0.05 (0.002)

## Benefits cont'd

- Capacitance offerings ranging from 330 pF – 0.22 µF
- Available capacitance tolerances of ±5%, ±10%, and ±20%
- Non-polar device, minimizing installation concerns
- 100% pure matte tin-plated termination finish allowing for excellent solderability
- SnPb termination finish option available upon request (5% minimum)
- Flexible termination option available upon request
- Commercial and Automotive (AEC-Q200) grades available

## Applications

Typical applications include those that can benefit from board area savings, cost savings and overall volumetric reduction such as telecommunications, computers, handheld devices and automotive.

## Qualification/Certification

Commercial Grade products are subject to internal qualification. Details regarding test methods and conditions are referenced in Table 4, Performance & Reliability.

Automotive Grade products meet or exceed the requirements outlined by the Automotive Electronics Council. Details regarding test methods and conditions are referenced in document AEC-Q200, Stress Test Qualification for Passive Components. For additional information regarding the Automotive Electronics Council and AEC-Q200, please visit their website at [www.aecouncil.com](http://www.aecouncil.com).

## Environmental Compliance

Pb-Free and RoHS Compliant (excluding SnPb termination finish option).



RoHS Compliant

## Electrical Parameters/Characteristics

Item	Parameters/Characteristics
Operating Temperature Range	-55°C to +125°C
Capacitance Change with Reference to +25°C and 0 VDC Applied (TCC)	±15%
Aging Rate (Maximum % Capacitance Loss/Decade Hour)	3.0%
Dielectric Withstanding Voltage (DWV)	250% of rated voltage (5 ±1 seconds and charge/discharge not exceeding 50 mA)
Dissipation Factor (DF) Maximum Limit @ 25°C	5%(10 V), 3.5%(16 V and 25 V) and 2.5%(50 V to 200 V)
Insulation Resistance (IR) Limit @ 25°C	1,000 megohm microfarads or 100 GΩ (Rated voltage applied for 120 ±5 seconds @ 25°C)

Regarding aging rate: Capacitance measurements (including tolerance) are indexed to a referee time of 1,000 hours.

To obtain IR limit, divide MΩ-μF value by the capacitance and compare to GΩ limit. Select the lower of the two limits.

Capacitance and dissipation factor (DF) measured under the following conditions:

1 kHz ±50 Hz and 1.0 ±0.2 Vrms if capacitance ≤ 10 μF

120 Hz ±10 Hz and 0.5 ±0.1 Vrms if capacitance > 10 μF

Note: When measuring capacitance it is important to ensure the set voltage level is held constant. The HP4284 and Agilent E4980 have a feature known as Automatic Level Control (ALC). The ALC feature should be switched to "ON."

## Post Environmental Limits

High Temperature Life, Biased Humidity, Moisture Resistance					
Dielectric	Rated DC Voltage	Capacitance Value	Dissipation Factor (Maximum %)	Capacitance Shift	Insulation Resistance
X7R	> 25	All	3.0	±20%	10% of Initial Limit
	16/25		5.0		
	< 16		7.5		

**Table 1 – Capacitance Range/Selection Waterfall (0508 – 0612 Case Sizes)**

Capacitance	Capacitance Code	Case Size / Series			C0508 (CA052C 2-Cap Case Size)					C0612 (CA064C 4-Cap Case Size)					
		Voltage Code			8	4	3	5	1	8	4	3	5	1	2
		Rated Voltage (VDC)			10	16	25	50	100	10	16	25	50	100	200
		Capacitance Tolerance			Product Availability and Chip Thickness Codes See Table 2 for Chip Thickness Dimensions										
330 pF	331	J	K	M	PA	PA	PA	PA	PA	MA	MA	MA	MA	MA	MA
390 pF	391	J	K	M	PA	PA	PA	PA	PA	MA	MA	MA	MA	MA	MA
470 pF	471	J	K	M	PA	PA	PA	PA	PA	MA	MA	MA	MA	MA	MA
560 pF	561	J	K	M	PA	PA	PA	PA	PA	MA	MA	MA	MA	MA	MA
680 pF	681	J	K	M	PA	PA	PA	PA	PA	MA	MA	MA	MA	MA	MA
820 pF	821	J	K	M	PA	PA	PA	PA	PA	MA	MA	MA	MA	MA	
1,000 pF	102	J	K	M	PA	PA	PA	PA	PA	MA	MA	MA	MA	MA	
1,200 pF	122	J	K	M	PA	PA	PA	PA	PA	MA	MA	MA	MA	MA	
1,500 pF	152	J	K	M	PA	PA	PA	PA	PA	MA	MA	MA	MA	MA	
1,800 pF	182	J	K	M	PA	PA	PA	PA	PA	MA	MA	MA	MA	MA	
2,200 pF	222	J	K	M	PA	PA	PA	PA	PA	MA	MA	MA	MA	MA	
2,700 pF	272	J	K	M	PA	PA	PA	PA	PA	MA	MA	MA	MA	MA	
3,300 pF	332	J	K	M	PA	PA	PA	PA	PA	MA	MA	MA	MA	MA	
3,900 pF	392	J	K	M	PA	PA	PA	PA	PA	MA	MA	MA	MA	MA	
4,700 pF	472	J	K	M	PA	PA	PA	PA	PA	MA	MA	MA	MA	MA	
5,600 pF	562	J	K	M	PA	PA	PA	PA		MA	MA	MA	MA		
6,800 pF	682	J	K	M	PA	PA	PA	PA		MA	MA	MA	MA		
8,200 pF	822	J	K	M	PA	PA	PA	PA		MA	MA	MA	MA		
10,000 pF	103	J	K	M	PA	PA	PA	PA		MA	MA	MA	MA		
12,000 pF	123	J	K	M	PA	PA	PA	PA		MA	MA	MA	MA		
15,000 pF	153	J	K	M	PA	PA	PA	PA		MA	MA	MA	MA		
18,000 pF	183	J	K	M	PA	PA	PA	PA		MA	MA	MA	MA		
22,000 pF	223	J	K	M	PA	PA	PA	PA		MA	MA	MA	MA		
27,000 pF	273	J	K	M	PA	PA	PA	PA		MA	MA	MA	MA		
33,000 pF	333	J	K	M	PA	PA	PA	PA		MA	MA	MA			
39,000 pF	393	J	K	M	PA	PA	PA	PA		MA	MA	MA			
47,000 pF	473	J	K	M	PA	PA	PA	PA		MA	MA	MA			
56,000 pF	563	J	K	M	PA	PA	PA	PA		MA	MA	MA			
68,000 pF	683	J	K	M	PA	PA	PA	PA		MA	MA				
82,000 pF	823	J	K	M	PA	PA	PA	PA		MA	MA				
0.10 uF	104	J	K	M	PA	PA	PA	PA		MA	MA				
0.15 uF	154	J	K	M	PA										
0.22 uF	224	J	K	M	PA										
Capacitance	Capacitance Code	Rated Voltage (VDC)			10	16	25	50	100	10	16	25	50	100	200
		Voltage Code			8	4	3	5	1	8	4	3	5	1	2
		Case Size / Series			C0508					C0612					

**Table 2 – Chip Thickness / Packaging Quantities**

Thickness Code	Case Size	Thickness ± Range (mm)	Paper Quantity		Plastic Quantity	
			7" Reel	13" Reel	7" Reel	13" Reel
PA	0508	0.80 ± 0.10	0	0	4,000	10,000
MA	0612	0.80 ± 0.10	0	0	4,000	10,000

Package quantity based on finished chip thickness specifications.

**Table 3 – Chip Capacitor Array Land Pattern Design Recommendations per IPC–7351**

EIA SIZE CODE	METRIC SIZE CODE	Density Level A: Maximum (Most) Land Protrusion (mm)						Density Level B: Median (Nominal) Land Protrusion (mm)						Density Level C: Minimum (Least) Land Protrusion (mm)					
		C	Y	X	P	V1	V2	C	Y	X	P	V1	V2	C	Y	X	P	V1	V2
0508/CA052	1220	1.60	1.00	0.55	1.00	3.50	3.30	1.50	0.90	0.50	1.00	2.90	2.80	1.40	0.75	0.45	1.00	2.40	2.50
0612/CA064	1632	1.80	1.10	0.50	0.80	3.90	4.40	1.80	0.95	0.50	0.80	3.30	3.90	1.70	0.85	0.40	0.80	2.80	3.60

**Density Level A:** For low-density product applications. Provides a wider process window for reflow solder processes.

**Density Level B:** For products with a moderate level of component density. Provides a robust solder attachment condition for reflow solder processes.

**Density Level C:** For high component density product applications. Before adapting the minimum land pattern variations the user should perform qualification testing based on the conditions outlined in IPC Standard 7351 (IPC–7351).

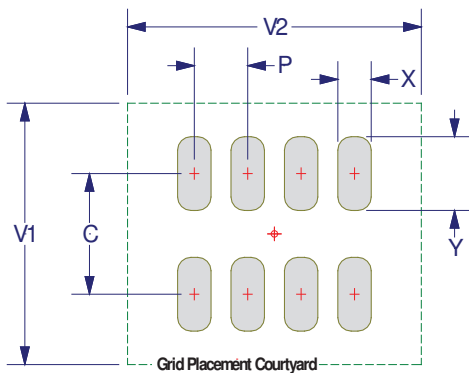

## Soldering Process

Recommended Soldering Technique:

- Solder reflow only

Recommended Soldering Profile:

- KEMET recommends following the guidelines outlined in IPC/JEDEC J–STD–020

**Table 4 – Performance & Reliability: Test Methods and Conditions**

Stress	Reference	Test or Inspection Method
Terminal Strength	JIS-C-6429	Appendix 1, Note: Force of 1.8 kg for 60 seconds.
Board Flex	JIS-C-6429	Appendix 2, Note: Standard termination system – 2.0 mm (minimum) for all except 3 mm for COG. Flexible termination system – 3.0 mm (minimum).
Solderability	J-STD-002	Magnification 50 X. Conditions:
		a) Method B, 4 hours @ 155°C, dry heat @ 235°C
		b) Method B @ 215°C category 3
		c) Method D, category 3 @ 260°C
Temperature Cycling	JESD22 Method JA-104	1,000 Cycles (-55°C to +125°C). Measurement at 24 hours +/- 2 hours after test conclusion.
Biased Humidity	MIL-STD-202 Method 103	Load Humidity: 1,000 hours 85°C/85% RH and rated voltage. Add 100 K ohm resistor. Measurement at 24 hours +/- 2 hours after test conclusion.
		Low Volt Humidity: 1,000 hours 85°C/85% RH and 1.5 V. Add 100 K ohm resistor. Measurement at 24 hours +/- 2 hours after test conclusion.
Moisture Resistance	MIL-STD-202 Method 106	t = 24 hours/cycle. Steps 7a and 7b not required. Unpowered. Measurement at 24 hours +/- 2 hours after test conclusion.
Thermal Shock	MIL-STD-202 Method 107	-55°C/+125°C. Note: Number of cycles required – 300, maximum transfer time – 20 seconds, dwell time – 15 minutes. Air – Air.
High Temperature Life	MIL-STD-202 Method 108 /EIA-198	1,000 hours at 125°C (85°C for X5R, Z5U and Y5V) with 2 X rated voltage applied.
Storage Life	MIL-STD-202 Method 108	150°C, 0 VDC for 1,000 hours.
Vibration	MIL-STD-202 Method 204	5 g's for 20 min., 12 cycles each of 3 orientations. Note: Use 8" X 5" PCB 0.031" thick 7 secure points on one long side and 2 secure points at corners of opposite sides. Parts mounted within 2" from any secure point. Test from 10 – 2,000 Hz
Mechanical Shock	MIL-STD-202 Method 213	Figure 1 of Method 213, Condition F.
Resistance to Solvents	MIL-STD-202 Method 215	Add aqueous wash chemical, OKEM Clean or equivalent.

## Storage & Handling

Ceramic chip capacitors should be stored in normal working environments. While the chips themselves are quite robust in other environments, solderability will be degraded by exposure to high temperatures, high humidity, corrosive atmospheres, and long term storage. In addition, packaging materials will be degraded by high temperature– reels may soften or warp and tape peel force may increase. KEMET recommends that maximum storage temperature not exceed 40°C and maximum storage humidity not exceed 70% relative humidity. Temperature fluctuations should be minimized to avoid condensation on the parts and atmospheres should be free of chlorine and sulfur bearing compounds. For optimized solderability chip stock should be used promptly, preferably within 1.5 years of receipt.

## Construction – Standard Termination

Reference	Item	Material
A	Termination System	Finish
B		Barrier Layer
C		Base Metal
D	Inner Electrode	Ni
E	Dielectric Material	BaTiO <sub>3</sub>

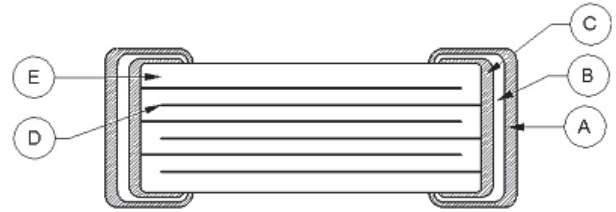

Note: Image is exaggerated in order to clearly identify all components of construction.

## Construction – Flexible Termination

Reference	Item	Material
A	Termination System	Finish
B		Barrier Layer
C		Epoxy Layer
D		Base Metal
E	Inner Electrode	Ni
F	Dielectric Material	BaTiO <sub>3</sub>

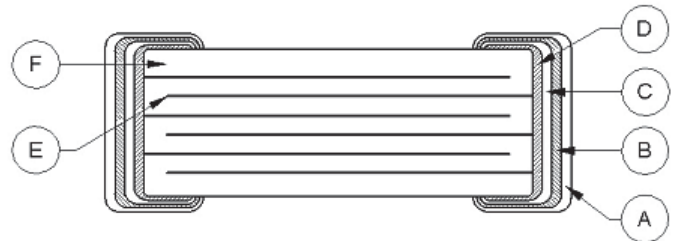

Note: Image is exaggerated in order to clearly identify all components of construction.



# Commercial Off-the-Shelf (COTS) for Higher Reliability Applications, C0G Dielectric, 10 – 200 VDC

## Overview

KEMET’s COTS program is an extension of KEMET knowledge of high reliability test regimes and requirements. KEMET regularly supplies “up-screened” products by working with customer drawings and imposing specified design and test requirements. The COTS program offers the same high quality and high reliability components as up-screened products, but at a lower cost to the customer. This is accomplished by eliminating the need for customer-specific drawings to achieve the reliability level required for customer applications. A series of tests and inspections have been selected to provide the accelerated conditioning and 100% screening necessary to eliminate infant mortal failures from the population.

KEMET’s C0G dielectric features a 125°C maximum operating temperature and is considered “stable.” The Electronics Components, Assemblies & Materials Association (EIA) characterizes C0G dielectric as a Class I material. Components of this classification are temperature compensating and are suited for resonant circuit applications or those where Q and stability of capacitance characteristics are required. C0G exhibits no change in capacitance with respect to time and voltage and boasts a negligible change in capacitance with reference to ambient

temperature. Capacitance change is limited to ±30 ppm/°C from -55°C to +125°C.

All COTS testing includes voltage conditioning and post-electrical testing as per MIL-PRF-55681. For enhanced reliability, KEMET also provides the following test level options and conformance certifications:

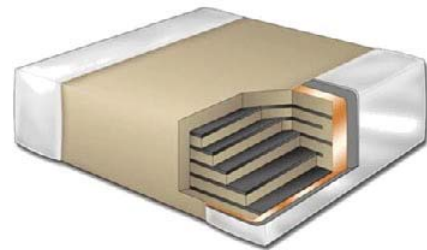
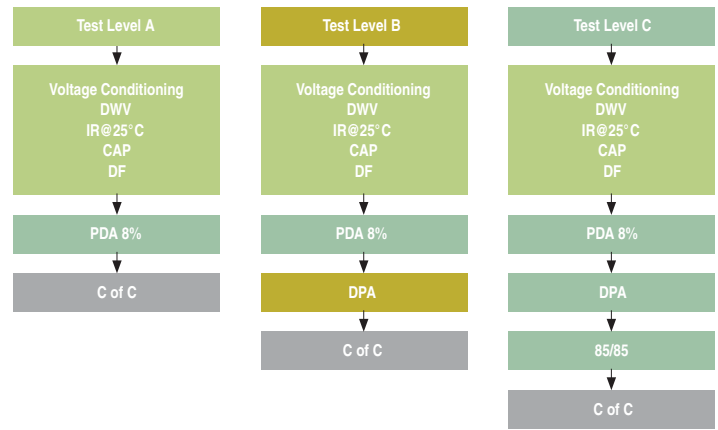

## Ordering Information

C	1206	T	104	K	5	G	A	C	TU
Ceramic	Case Size (L" x W")	Specification/ Series	Capacitance Code (pF)	Capacitance Tolerance <sup>1</sup>	Voltage	Dielectric	Failure Rate/Design	Termination Finish <sup>2</sup>	Packaging/Grade (C-Spec) <sup>3</sup>
	0402 0603 0805 1206 1210 1812 2220	T = COTS	2 Significant Digits + Number of Zeros Use 9 for 1.0 – 9.9 pF Use 8 for 0.5 – .99 pF ex. 2.2 pF = 229 ex. 0.5 pF = 508	B = ±0.10 pF C = ±0.25 pF D = ±0.5 pF F = ± 1% G = ±2% J = ±5% K = ±10% M = ±20%	8 = 10 V 4 = 16 V 3 = 25 V 6 = 35 V 5 = 50 V 1 = 100 V 2 = 200 V	G = C0G	A = Testing per MIL-PRF-55681 PDA 8% B= Testing per MIL-PRF-55681 PDA 8%, DPA per EIA-469 C = Testing per MIL-PRF-55681 PDA 8%, DPA per EIA-469, Humidity per MIL-STD-202, Method 103, Condition A	C = 100% Matte Sn L = SnPb (5% minimum)	Blank = Bulk TU = 7" Reel Unmarked TM = 7" Reel Marked

<sup>1</sup> Additional capacitance tolerance offerings may be available. Contact KEMET for details.

<sup>2</sup> Additional termination finish options may be available. Contact KEMET for details.

<sup>3</sup> Additional reeling or packaging options may be available. Contact KEMET for details.