



Chipsmall Limited consists of a professional team with an average of over 10 year of expertise in the distribution of electronic components. Based in Hongkong, we have already established firm and mutual-benefit business relationships with customers from,Europe,America and south Asia,supplying obsolete and hard-to-find components to meet their specific needs.

With the principle of “Quality Parts,Customers Priority,Honest Operation,and Considerate Service”,our business mainly focus on the distribution of electronic components. Line cards we deal with include Microchip,ALPS,ROHM,Xilinx,Pulse,ON,Everlight and Freescale. Main products comprise IC,Modules,Potentiometer,IC Socket,Relay,Connector.Our parts cover such applications as commercial,industrial, and automotives areas.

We are looking forward to setting up business relationship with you and hope to provide you with the best service and solution. Let us make a better world for our industry!



Contact us

Tel: +86-755-8981 8866 Fax: +86-755-8427 6832

Email & Skype: info@chipsmall.com Web: www.chipsmall.com

Address: A1208, Overseas Decoration Building, #122 Zhenhua RD., Futian, Shenzhen, China



TINA2-M

~30° medium beam optimized for CREE XP-E.
Assembly with holder and installation tape.

TECHNICAL SPECIFICATIONS:

Dimensions	Ø 16.1 mm
Height	9.7 mm
Fastening	tape
Colour	black
Box size	451 x 241 x 298 mm
Box weight	8.1 kg
Quantity in Box	4140 pcs
ROHS compliant	yes ⓘ

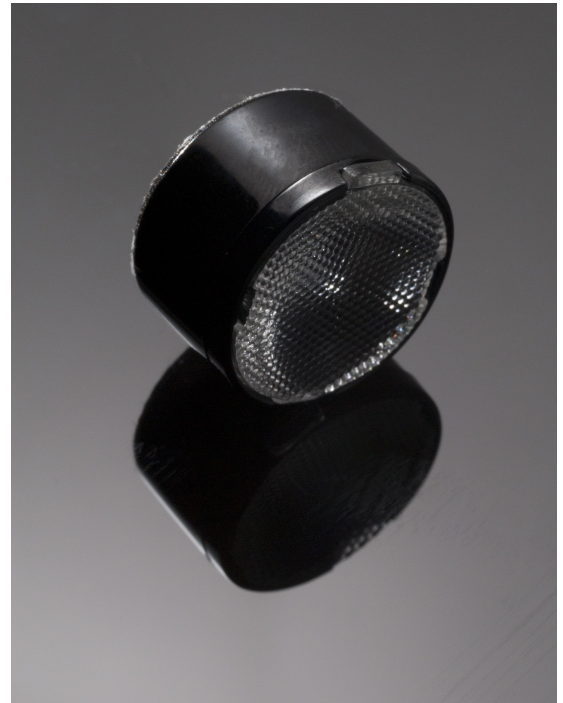

MATERIAL SPECIFICATIONS:

Component	Type	Material	Colour
TINA2-XP-M	Lens	PMMA	clear
TINA2-XP-HLD-TAPE-BLK	Holder	PC	black
TINA-TAPE3	Tape	PU tape	black

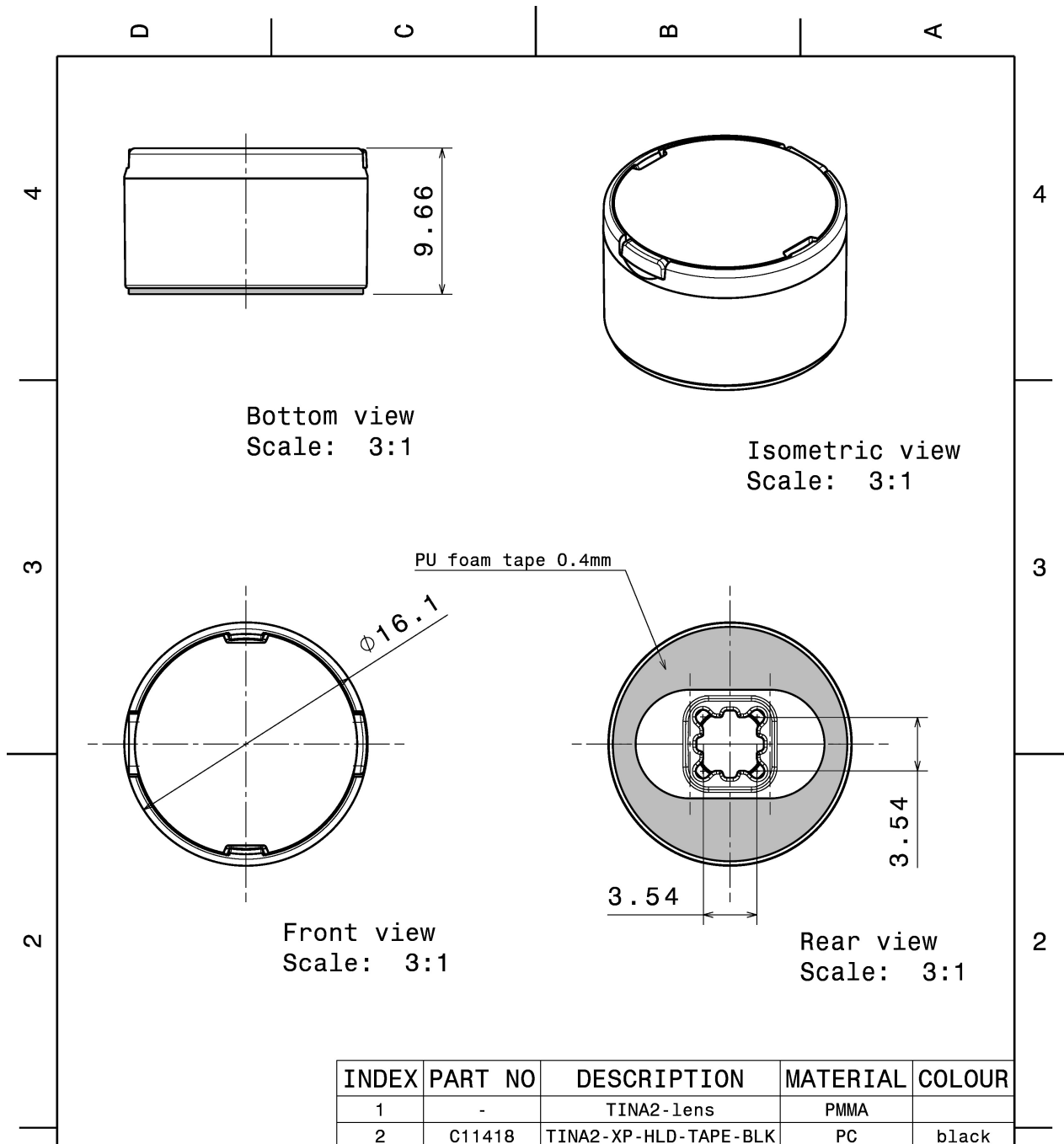

INDEX	PART NO	DESCRIPTION	MATERIAL	COLOUR
1	-	TINA2-lens	PMMA	
2	C11418	TINA2-XP-HLD-TAPE-BLK	PC	black

Tolerances if not otherwise shown
According to DIN ISO 2768-1
Linear measures:
Up to 30mm class M, otherwise class C.
According to DIN ISO 2768-2
Form and position: class L

LEDiL

Ledil Oy
Salorankatu 10
FIN 24240 SALO
Finland

THIRD ANGLE PROJECTION: 

DRAWING TITLE

TINA2-XP-series assembly

This drawing is the property of LEDiL Oy. It may not be reproduced, copied or communicated without a written agreement with LEDiL Oy.

SIZE PART NUMBER

A4

-

SCALE

3:1

WEIGHT

1,3 g

SHEET

1/1

PHOTOMETRIC DATA (MEASURED):

CREE 

LED XP-E
 FWHM 31.0°
 Efficiency 89 %
 Peak intensity 2.560 cd/lm
 Required components:

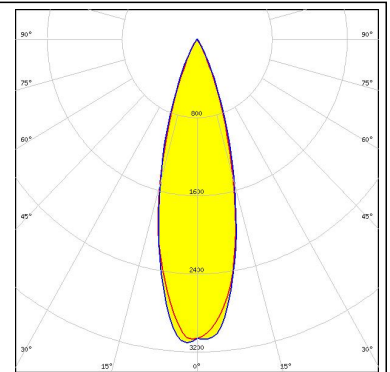

CREE 

LED XP-E-HEW
 FWHM 30.0°
 Efficiency %
 Peak intensity 2.290 cd/lm
 Required components:

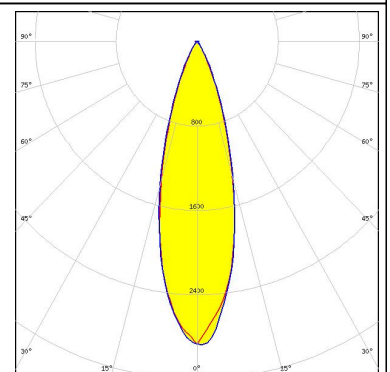

CREE 

LED XP-E2
 FWHM 32.0°
 Efficiency 86 %
 Peak intensity 3.000 cd/lm
 Required components:

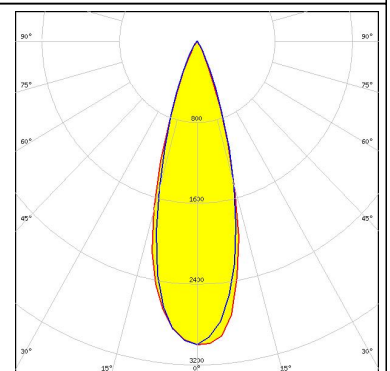
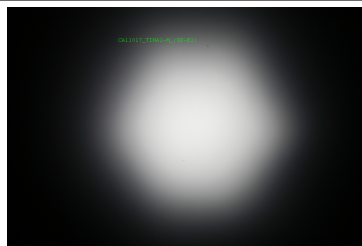

CREE 

LED XP-G
 FWHM 30.0°
 Efficiency 88 %
 Peak intensity 2.800 cd/lm
 Required components:

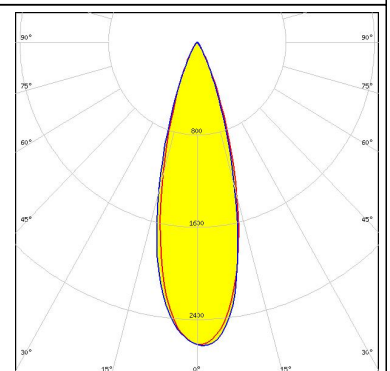

PHOTOMETRIC DATA (MEASURED):



LED XP-G2
 FWHM 26.0°
 Efficiency 84 %
 Peak intensity 3.200 cd/lm
 Required components:

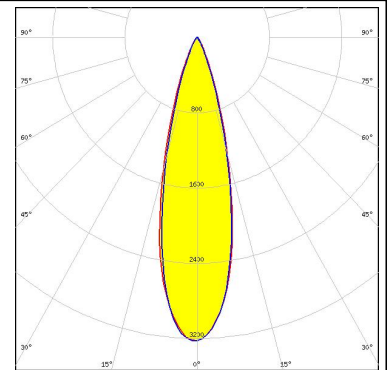
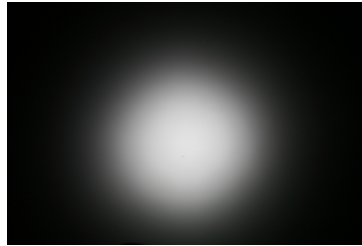

LED XT-E
 FWHM 31.0°
 Efficiency 81 %
 Peak intensity 2.600 cd/lm
 Required components:

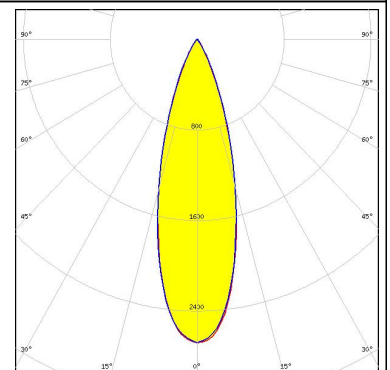

LED H35B0 (LEMWA32)
 FWHM 30.0°
 Efficiency 86 %
 Peak intensity 2.800 cd/lm
 Required components:

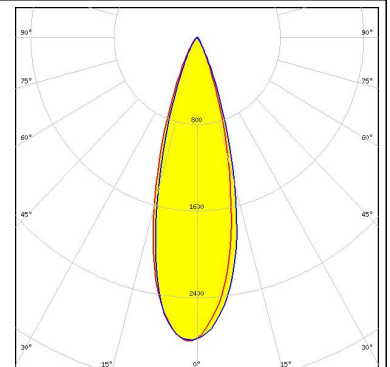

LED H35C0 (LEMWA33)
 FWHM 30.0°
 Efficiency 85 %
 Peak intensity 2.550 cd/lm
 Required components:

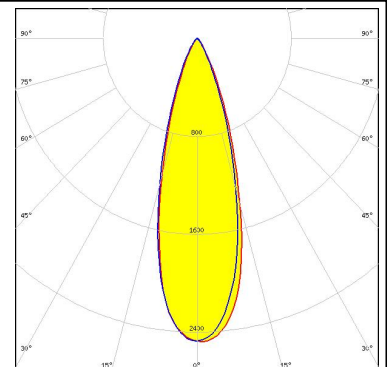

PHOTOMETRIC DATA (MEASURED):

LG Innotek

LED H35C1 (LEMWA33)

FWHM 31.0°

Efficiency 84 %

Peak intensity 2.700 cd/lm

Required components:

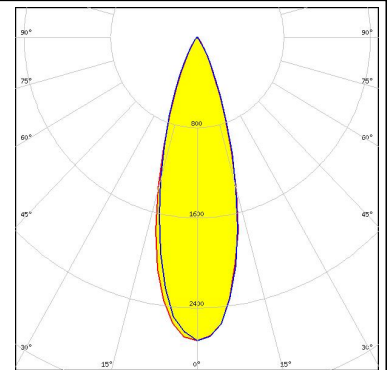
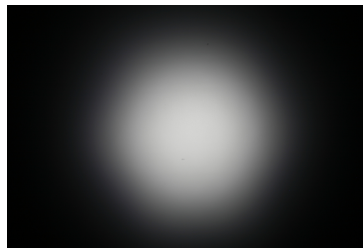

SEUL SEMICONDUCTOR

LED Z5M1/Z5M2

FWHM 29.0°

Efficiency 84 %

Peak intensity 2.900 cd/lm

Required components:

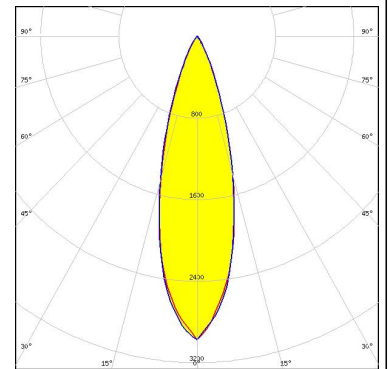
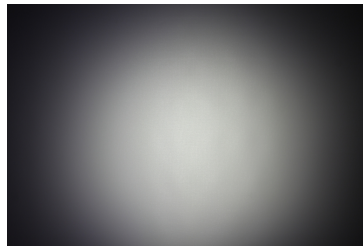

GENERAL INFORMATION:

NOTE: The typical beam angle will be changed by different color, chip size and chip position tolerance. The typical total beam angle is the full angle measured where the luminous intensity is half of the peak value.

MATERIALS:

As part of our continuous research and improvement processes, and to ensure the best possible quality and availability of our products, LEDiL reserves the right to change material grades without notice.

PRODUCT DATA USER AGREEMENT AND DISCLAIMER:

The measured data in the provided downloadable LEDiL Product Datasheets and Mechanical 2D-Drawings is rounded and provided as reference for planning. LEDiL Oy's optical specifications have been verified by conducting performance testing of the products in accordance with the company's quality system. The reported data are averaged results of multiple measurements with typical variation. LEDiL Oy reserves the right to without prior notification make changes and improvements to its products.

LEDiL Oy assumes neither warranty, nor guarantee nor any other liability of any kind for the contents and correctness of the provided data. The provided data has been generated with highest diligence but the provided data may in reality not represent the complete possible variation range of all intrinsic parameters. Therefore, in certain cases a deviation from the provided data could occur.

LEDiL Oy reserves the right to undertake technical changes of its products without further notification which could lead to changes in the provided data. LEDiL Oy assumes no liability of any kind for the possible deviation from any provided data or any other damage resulting from the usage of the provided data.

The user agrees to this disclaimer and user agreement with the download or usage of the provided files.

LEDiL Oy

Joensuunkatu 13
FI-24240 SALO
Finland

LEDiL Inc.

228 West Page Street
Suite D
Sycamore IL 60178
USA

Local sales and technical support

[www.ledil.com/
where_to_buy](http://www.ledil.com/where_to_buy)

Shipping locations

Salo, Finland
Hong Kong, China

Distribution Partners

[www.ledil.com/
where_to_buy](http://www.ledil.com/where_to_buy)