



Chipsmall Limited consists of a professional team with an average of over 10 year of expertise in the distribution of electronic components. Based in Hongkong, we have already established firm and mutual-benefit business relationships with customers from,Europe,America and south Asia,supplying obsolete and hard-to-find components to meet their specific needs.

With the principle of “Quality Parts,Customers Priority,Honest Operation,and Considerate Service”,our business mainly focus on the distribution of electronic components. Line cards we deal with include Microchip,ALPS,ROHM,Xilinx,Pulse,ON,Everlight and Freescale. Main products comprise IC,Modules,Potentiometer,IC Socket,Relay,Connector.Our parts cover such applications as commercial,industrial, and automotives areas.

We are looking forward to setting up business relationship with you and hope to provide you with the best service and solution. Let us make a better world for our industry!



Contact us

Tel: +86-755-8981 8866 Fax: +86-755-8427 6832

Email & Skype: info@chipsmall.com Web: www.chipsmall.com

Address: A1208, Overseas Decoration Building, #122 Zhenhua RD., Futian, Shenzhen, China



HEIDI-M

~25° medium beam

TECHNICAL SPECIFICATIONS:

Dimensions	Ø 21.6 mm
Height	11.9 mm
Fastening	tape, pin
Colour	clear
Box size	480 x 280 x 300 mm
Box weight	10.8 kg
Quantity in Box	3264 pcs
ROHS compliant	yes ⓘ

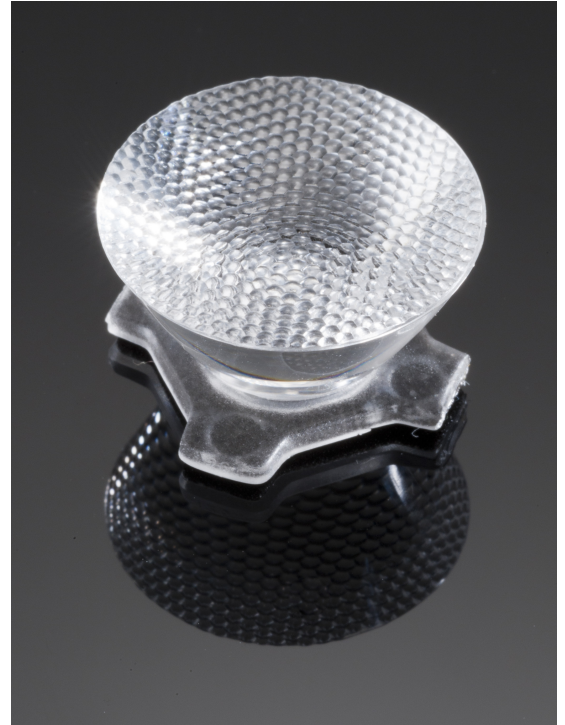

MATERIAL SPECIFICATIONS:

Component	Type	Material	Colour
HEIDI-M	Lens	PMMA	clear
HEIDI-TAPE	Tape	PU tape	black

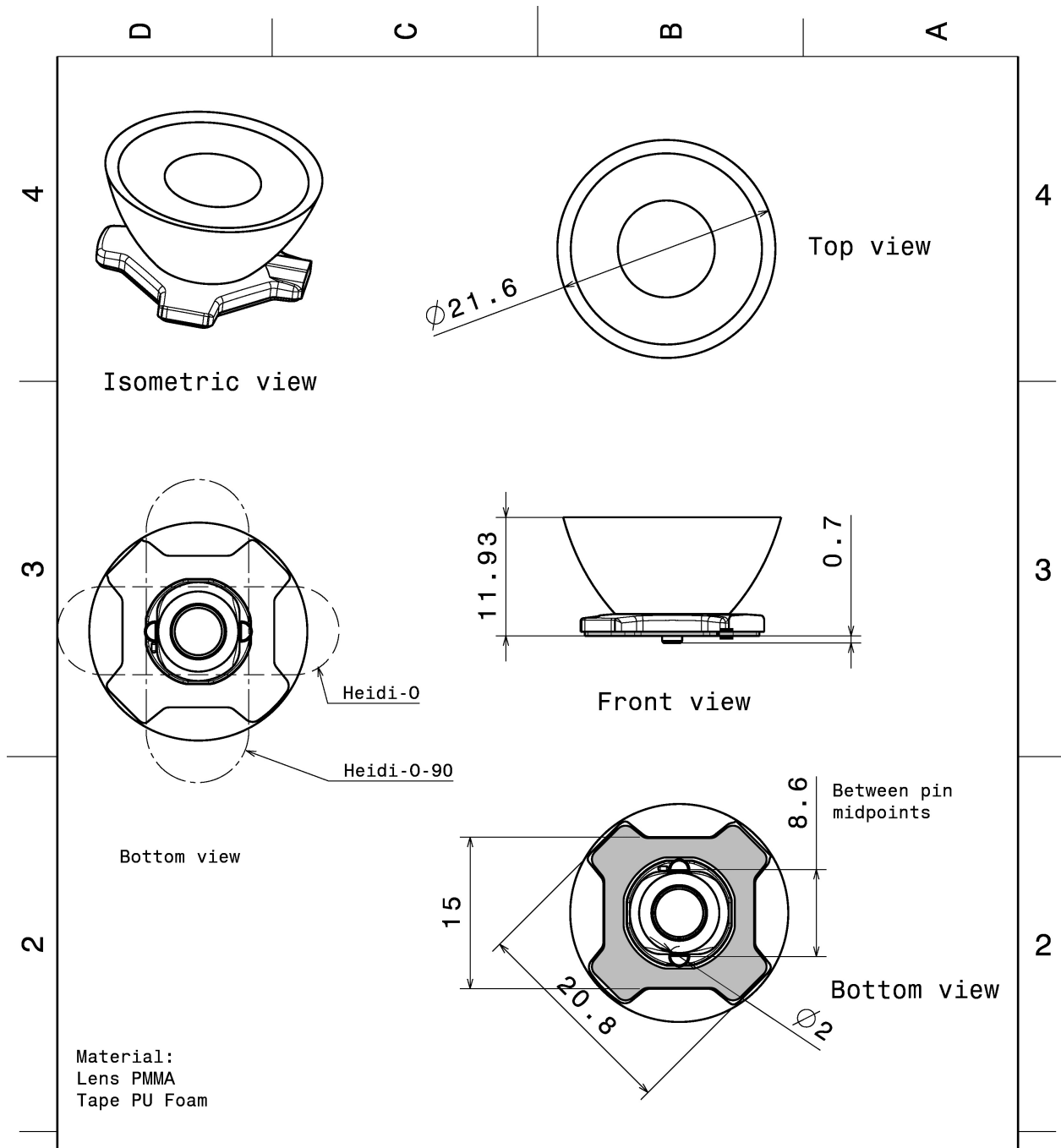

This drawing is our property. It can't be reproduced or communicated without our written agreement.		LEDiL A WORLD OF INNOVATION		Ledil Oy Joensuunkatu 13 FIN-24100 SALO Finland	
DRAWN BY ah		DATE 24.6.2013		DRAWING TITLE Datasheet Heidi-0 assy	
CHECKED BY		DATE		SIZE A4	
DESIGNED BY		DATE		DRAWING NUMBER	
		SCALE 2:1		WEIGHT (g)	
				REV 001	
				SHEET 1/1	

PHOTOMETRIC DATA (MEASURED):

CREE ⇄

LED XB-D
FWHM 29.0°
Efficiency 87 %
Peak intensity 2.000 cd/lm
Required components:

CREE ⇄

LED XB-H
FWHM 27.0°
Efficiency 87 %
Peak intensity 3.400 cd/lm
Required components:

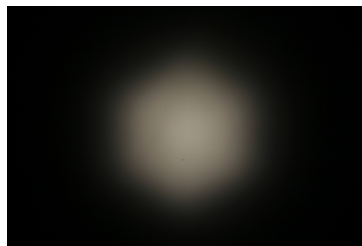

CREE ⇄

LED XP-E
FWHM 28.0°
Efficiency 92 %
Peak intensity 2.860 cd/lm
Required components:

CREE ⇄

LED XP-G
FWHM 28.0°
Efficiency 92 %
Peak intensity 3.300 cd/lm
Required components:

PHOTOMETRIC DATA (MEASURED):

LUMILEDS

LED LUXEON C
FWHM 26.0°
Efficiency 87 %
Peak intensity 3.950 cd/lm
Required components:

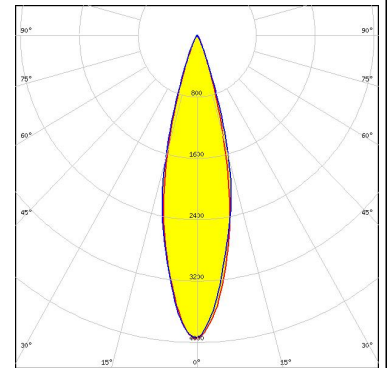
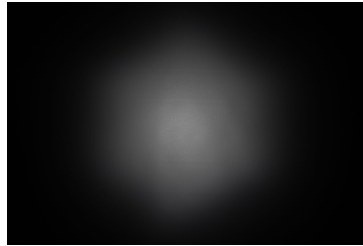

LUMILEDS

LED LUXEON CZ
FWHM 26.0°
Efficiency 94 %
Peak intensity 4.500 cd/lm
Required components:

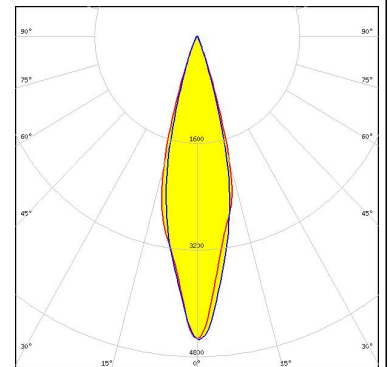

LUMILEDS

LED LUXEON T
FWHM 28.0°
Efficiency 87 %
Peak intensity 3.300 cd/lm
Required components:

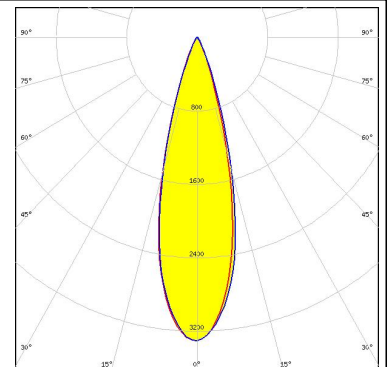

LUMILEDS

LED LUXEON TX
FWHM 29.0°
Efficiency 88 %
Peak intensity 3.400 cd/lm
Required components:

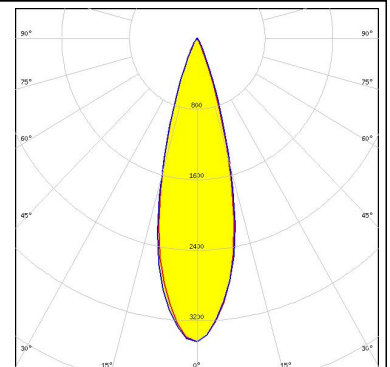
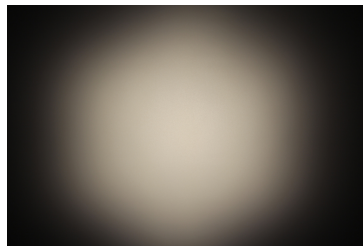

PHOTOMETRIC DATA (MEASURED):



LED NCSxx19A
FWHM 26.0°
Efficiency 87 %
Peak intensity 3.000 cd/lm
Required components:



LED NCSxx19B
FWHM 29.0°
Efficiency 88 %
Peak intensity 3.700 cd/lm
Required components:

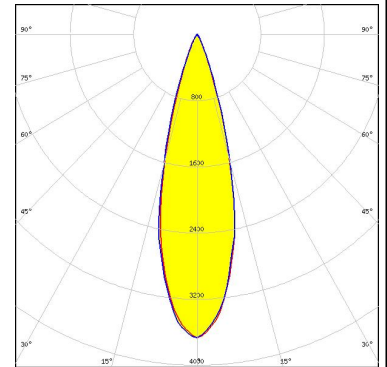
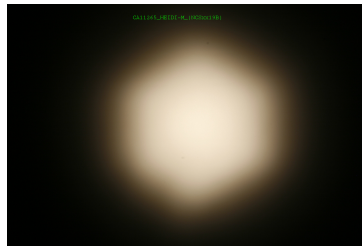

LED NVSxx19A
FWHM 28.0°
Efficiency 87 %
Peak intensity 3.100 cd/lm
Required components:



LED NVSxx19B/NVSxx19C
FWHM 28.0°
Efficiency 90 %
Peak intensity 3.300 cd/lm
Required components:

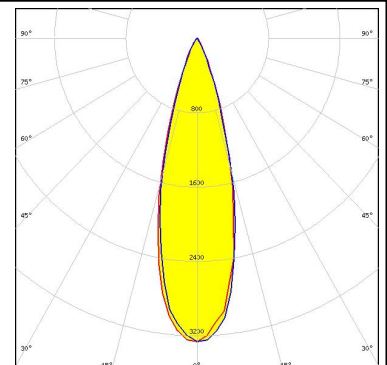
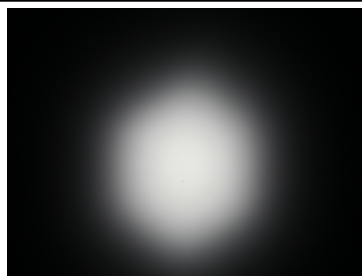

PHOTOMETRIC DATA (MEASURED):

OSRAM
Opto Semiconductors

LED Oslon SSL 150
FWHM 26.0°
Efficiency 90 %
Peak intensity 3.400 cd/lm
Required components:

OSRAM
Opto Semiconductors

LED Oslon SSL 80
FWHM 28.0°
Efficiency 87 %
Peak intensity 3.130 cd/lm
Required components:

SAMSUNG

LED LH181A
FWHM 27.0°
Efficiency 88 %
Peak intensity 2.900 cd/lm
Required components:

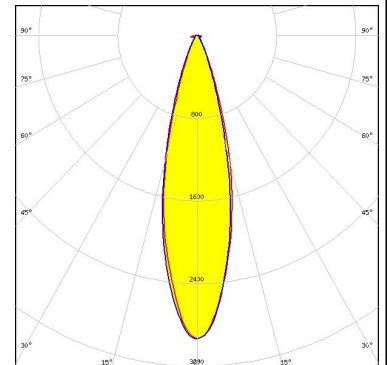
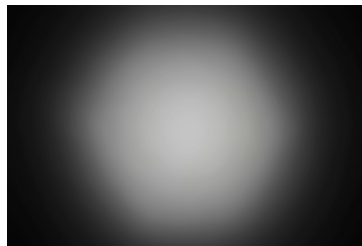

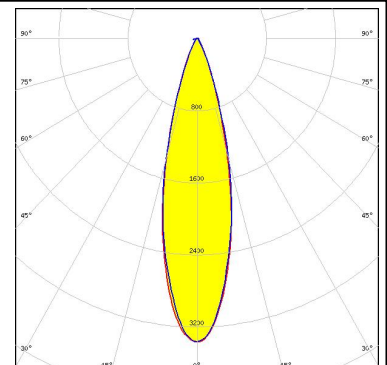
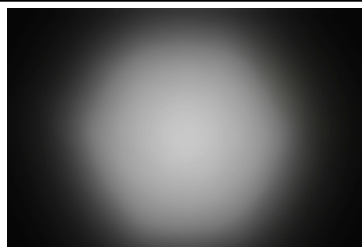

SAMSUNG

LED LH181B
FWHM 27.0°
Efficiency 93 %
Peak intensity 3.400 cd/lm
Required components:

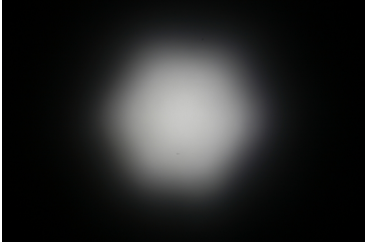
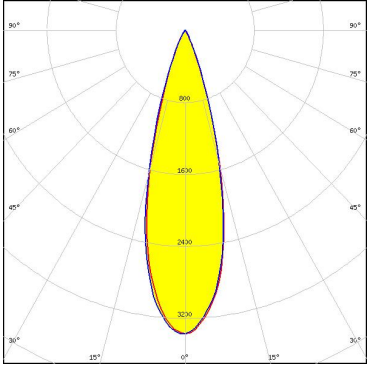

PHOTOMETRIC DATA (MEASURED):

 SEOUL SEMICONDUCTOR		
LED	Z5	
FWHM	28.0°	
Efficiency	87 %	
Peak intensity	3.670 cd/lm	
Required components:		
 SEOUL SEMICONDUCTOR		
LED	Z5M1/Z5M2	
FWHM	29.0°	
Efficiency	89 %	
Peak intensity	3.400 cd/lm	
Required components:		
		

PHOTOMETRIC DATA (SIMULATED):



LED XT-E
FWHM 28.0°
Efficiency 93 %
Peak intensity 3.700 cd/lm
Required components:

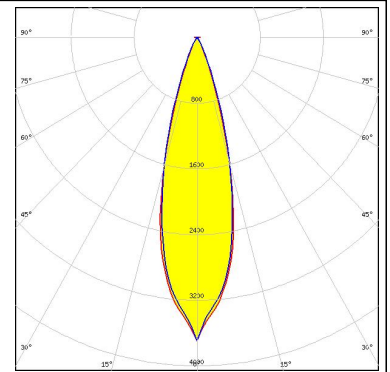

LED LUXEON Z ES
FWHM 28.0°
Efficiency 94 %
Peak intensity 4.050 cd/lm
Required components:

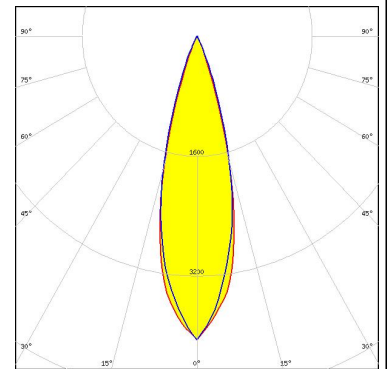

LED Oslon Square EC
FWHM 29.0°
Efficiency %
Peak intensity 3.200 cd/lm
Required components:



LED Oslon Square Gen3
FWHM 28.0°
Efficiency 94 %
Peak intensity 3.500 cd/lm
Required components:

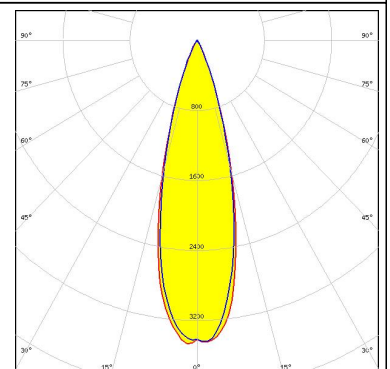

GENERAL INFORMATION:

NOTE: The typical beam angle will be changed by different color, chip size and chip position tolerance. The typical total beam angle is the full angle measured where the luminous intensity is half of the peak value.

MATERIALS:

As part of our continuous research and improvement processes, and to ensure the best possible quality and availability of our products, LEDiL reserves the right to change material grades without notice.

PRODUCT DATA USER AGREEMENT AND DISCLAIMER:

The measured data in the provided downloadable LEDiL Product Datasheets and Mechanical 2D-Drawings is rounded and provided as reference for planning. LEDiL Oy's optical specifications have been verified by conducting performance testing of the products in accordance with the company's quality system. The reported data are averaged results of multiple measurements with typical variation. LEDiL Oy reserves the right to without prior notification make changes and improvements to its products.

LEDiL Oy assumes neither warranty, nor guarantee nor any other liability of any kind for the contents and correctness of the provided data. The provided data has been generated with highest diligence but the provided data may in reality not represent the complete possible variation range of all intrinsic parameters. Therefore, in certain cases a deviation from the provided data could occur.

LEDiL Oy reserves the right to undertake technical changes of its products without further notification which could lead to changes in the provided data. LEDiL Oy assumes no liability of any kind for the possible deviation from any provided data or any other damage resulting from the usage of the provided data.

The user agrees to this disclaimer and user agreement with the download or usage of the provided files.

LEDiL Oy

Joensuunkatu 13
FI-24240 SALO
Finland

LEDiL Inc.

228 West Page Street
Suite D
Sycamore IL 60178
USA

Local sales and technical support

[www.ledil.com/
where_to_buy](http://www.ledil.com/where_to_buy)

Shipping locations

Salo, Finland
Hong Kong, China

Distribution Partners

[www.ledil.com/
where_to_buy](http://www.ledil.com/where_to_buy)