



Chipsmall Limited consists of a professional team with an average of over 10 year of expertise in the distribution of electronic components. Based in Hongkong, we have already established firm and mutual-benefit business relationships with customers from,Europe,America and south Asia,supplying obsolete and hard-to-find components to meet their specific needs.

With the principle of “Quality Parts,Customers Priority,Honest Operation,and Considerate Service”,our business mainly focus on the distribution of electronic components. Line cards we deal with include Microchip,ALPS,ROHM,Xilinx,Pulse,ON,Everlight and Freescale. Main products comprise IC,Modules,Potentiometer,IC Socket,Relay,Connector.Our parts cover such applications as commercial,industrial, and automotives areas.

We are looking forward to setting up business relationship with you and hope to provide you with the best service and solution. Let us make a better world for our industry!



Contact us

Tel: +86-755-8981 8866 Fax: +86-755-8427 6832

Email & Skype: info@chipsmall.com Web: www.chipsmall.com

Address: A1208, Overseas Decoration Building, #122 Zhenhua RD., Futian, Shenzhen, China



HEIDI-RS

~8° spot beam

TECHNICAL SPECIFICATIONS:

Dimensions	Ø 21.6 mm
Height	11.7 mm
Fastening	tape, pin
Colour	clear
Box size	480 x 280 x 300 mm
Box weight	10.4 kg
Quantity in Box	3264 pcs
ROHS compliant	yes ⓘ



MATERIAL SPECIFICATIONS:

Component	Type	Material	Colour
HEIDI-RS	Lens	PMMA	clear
HEIDI-TAPE	Tape	PU tape	black

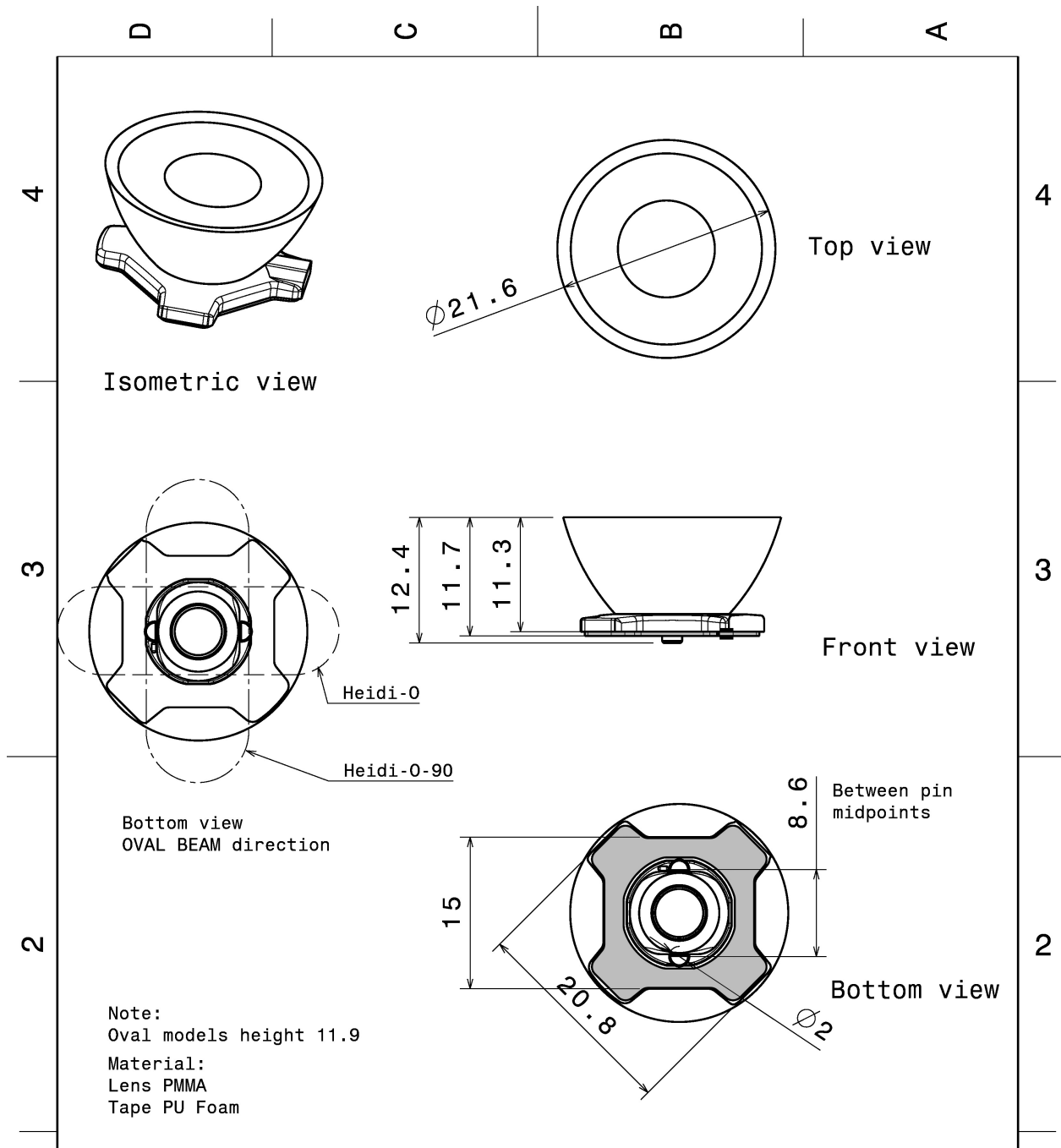

This drawing is our property. It can't be reproduced or communicated without our written agreement.		LEDiL		Ledil Oy Joensuunkatu 13 FIN-24100 SALO Finland	
DRAWING TITLE		Datasheet Heidi-Series Assy			
DRAWN BY ah	DATE 1.2.2012	SIZE A4	DRAWING NUMBER		REV 2
CHECKED BY	DATE	SCALE 2:1	WEIGHT (g)	SHEET 1/1	
DESIGNED BY	DATE				

PHOTOMETRIC DATA (MEASURED):

CREE

LED XB-D
FWHM 8.0°
Efficiency 91 %
Peak intensity 19.700 cd/lm
Required components:

CREE

LED XB-H
FWHM 10.0°
Efficiency 90 %
Peak intensity 18.300 cd/lm
Required components:



CREE

LED XP-E
FWHM 8.0°
Efficiency 93 %
Peak intensity 26.800 cd/lm
Required components:

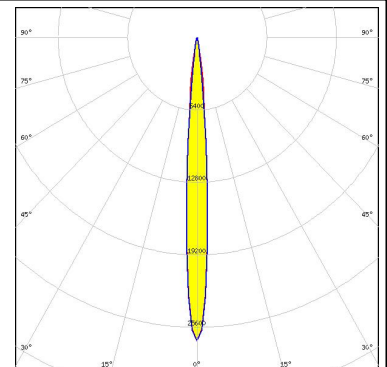

CREE

LED XP-E2
FWHM 8.0°
Efficiency 90 %
Peak intensity 38.000 cd/lm
Required components:

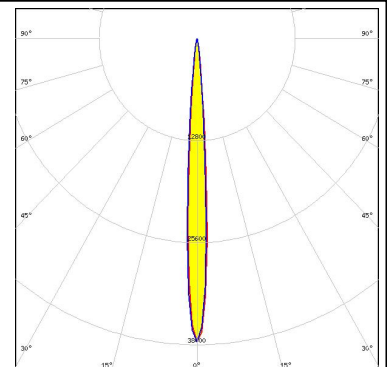

PHOTOMETRIC DATA (MEASURED):



LED XP-G
FWHM 9.0°
Efficiency 93 %
Peak intensity 16.600 cd/lm
Required components:



LED XP-G2
FWHM 11.0°
Efficiency 91 %
Peak intensity 19.100 cd/lm
Required components:

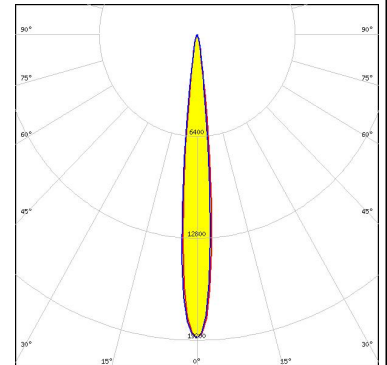

LED LUXEON C
FWHM 7.0°
Efficiency 92 %
Peak intensity 35.550 cd/lm
Required components:

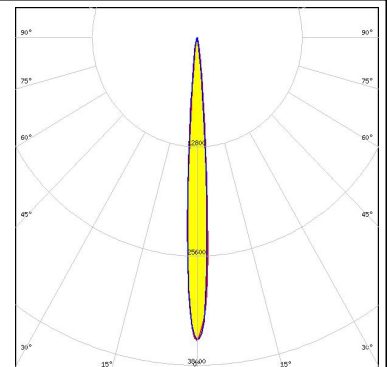

LED LUXEON T
FWHM 11.0°
Efficiency 92 %
Peak intensity 16.300 cd/lm
Required components:

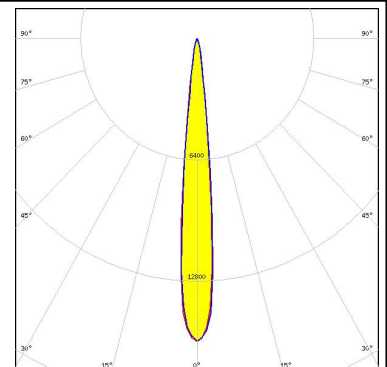

PHOTOMETRIC DATA (MEASURED):



LED LUXEON TX
FWHM 10.0°
Efficiency 90 %
Peak intensity 19.500 cd/lm
Required components:

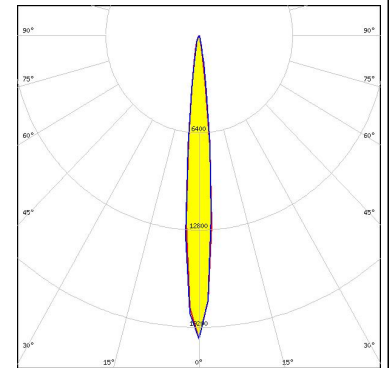

LED NCSxx19A
FWHM 8.0°
Efficiency 89 %
Peak intensity 19.000 cd/lm
Required components:



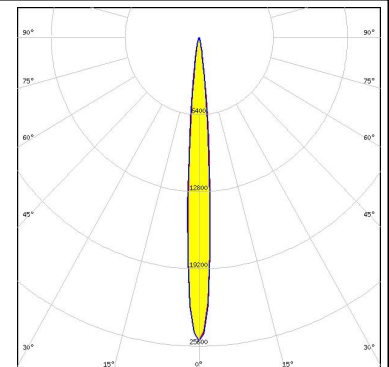
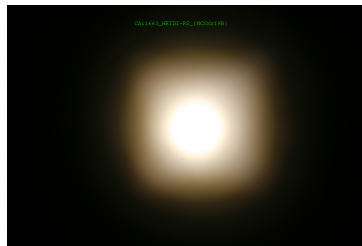

LED NCSxx19B
FWHM 9.0°
Efficiency 90 %
Peak intensity 25.200 cd/lm
Required components:

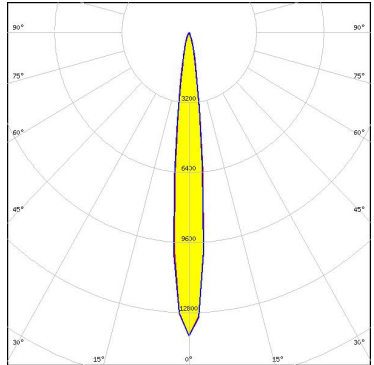

LED NVSxx19A
FWHM 10.0°
Efficiency 89 %
Peak intensity 13.900 cd/lm
Required components:

PHOTOMETRIC DATA (MEASURED):

<p>NICHIA</p> <p>LED NVSxx19B/NVSxx19C FWHM 12.0° Efficiency 92 % Peak intensity 13.900 cd/lm Required components:</p>		
<p>OSRAM Opto Semiconductors</p> <p>LED Oslon Square Gen3 FWHM 10.0° Efficiency 89 % Peak intensity 20.800 cd/lm Required components:</p>		
<p>OSRAM Opto Semiconductors</p> <p>LED Oslon SSL 150 FWHM 7.0° Efficiency 93 % Peak intensity 24.700 cd/lm Required components:</p>		
<p>OSRAM Opto Semiconductors</p> <p>LED Oslon SSL 80 FWHM 6.0° Efficiency 90 % Peak intensity 29.400 cd/lm Required components:</p>		

PHOTOMETRIC DATA (MEASURED):

SAMSUNG

LED LH181B
FWHM 9.0°
Efficiency 94 %
Peak intensity 15.000 cd/lm
Required components:

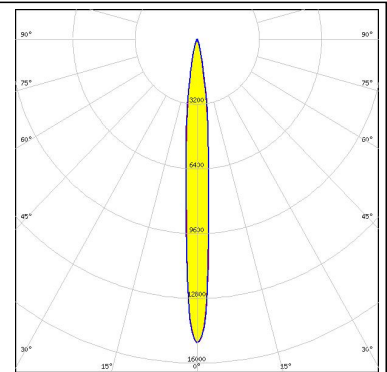

SAMSUNG

LED LH351Z
FWHM 11.0°
Efficiency 89 %
Peak intensity 20.700 cd/lm
Required components:

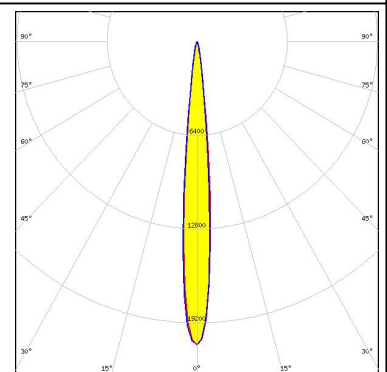

SEOUL SEMICONDUCTOR

LED Z5
FWHM 7.0°
Efficiency 93 %
Peak intensity 32.700 cd/lm
Required components:

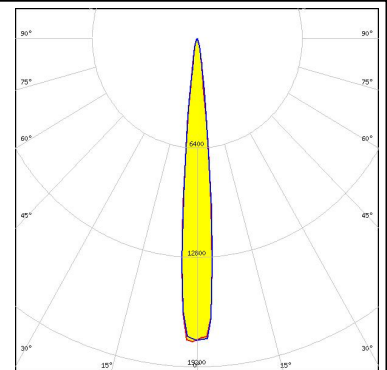

SEOUL SEMICONDUCTOR

LED Z5M1/Z5M2
FWHM 11.0°
Efficiency 94 %
Peak intensity 17.770 cd/lm
Required components:

PHOTOMETRIC DATA (SIMULATED):



LED LUXEON Z ES
FWHM 7.7°
Efficiency 94 %
Peak intensity 33.300 cd/lm
Required components:

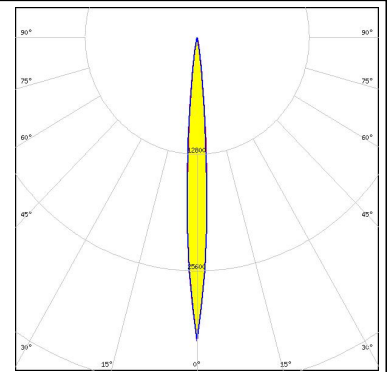

LED Oslon Square EC
FWHM 12.0°
Efficiency %
Peak intensity 11.750 cd/lm
Required components:

GENERAL INFORMATION:

NOTE: The typical beam angle will be changed by different color, chip size and chip position tolerance. The typical total beam angle is the full angle measured where the luminous intensity is half of the peak value.

MATERIALS:

As part of our continuous research and improvement processes, and to ensure the best possible quality and availability of our products, LEDiL reserves the right to change material grades without notice.

PRODUCT DATA USER AGREEMENT AND DISCLAIMER:

The measured data in the provided downloadable LEDiL Product Datasheets and Mechanical 2D-Drawings is rounded and provided as reference for planning. LEDiL Oy's optical specifications have been verified by conducting performance testing of the products in accordance with the company's quality system. The reported data are averaged results of multiple measurements with typical variation. LEDiL Oy reserves the right to without prior notification make changes and improvements to its products.

LEDiL Oy assumes neither warranty, nor guarantee nor any other liability of any kind for the contents and correctness of the provided data. The provided data has been generated with highest diligence but the provided data may in reality not represent the complete possible variation range of all intrinsic parameters. Therefore, in certain cases a deviation from the provided data could occur.

LEDiL Oy reserves the right to undertake technical changes of its products without further notification which could lead to changes in the provided data. LEDiL Oy assumes no liability of any kind for the possible deviation from any provided data or any other damage resulting from the usage of the provided data.

The user agrees to this disclaimer and user agreement with the download or usage of the provided files.

LEDiL Oy

Joensuunkatu 13
FI-24240 SALO
Finland

LEDiL Inc.

228 West Page Street
Suite D
Sycamore IL 60178
USA

Local sales and technical support

[www.ledil.com/
where_to_buy](http://www.ledil.com/where_to_buy)

Shipping locations

Salo, Finland
Hong Kong, China

Distribution Partners

[www.ledil.com/
where_to_buy](http://www.ledil.com/where_to_buy)