



Chipsmall Limited consists of a professional team with an average of over 10 year of expertise in the distribution of electronic components. Based in Hongkong, we have already established firm and mutual-benefit business relationships with customers from,Europe,America and south Asia,supplying obsolete and hard-to-find components to meet their specific needs.

With the principle of “Quality Parts,Customers Priority,Honest Operation,and Considerate Service”,our business mainly focus on the distribution of electronic components. Line cards we deal with include Microchip,ALPS,ROHM,Xilinx,Pulse,ON,Everlight and Freescale. Main products comprise IC,Modules,Potentiometer,IC Socket,Relay,Connector.Our parts cover such applications as commercial,industrial, and automotives areas.

We are looking forward to setting up business relationship with you and hope to provide you with the best service and solution. Let us make a better world for our industry!



Contact us

Tel: +86-755-8981 8866 Fax: +86-755-8427 6832

Email & Skype: info@chipsmall.com Web: www.chipsmall.com

Address: A1208, Overseas Decoration Building, #122 Zhenhua RD., Futian, Shenzhen, China



STRADA-SQ-T3

IESNA Type III (medium) beam for roads that are equal to or wider than mounting height. Version with location pins. Assembly with installation tape.

TECHNICAL SPECIFICATIONS:

Dimensions	25.0 mm
Height	8.4 mm
Fastening	tape, pin
Colour	clear
Box size	
Box weight	7.8 kg
Quantity in Box	pcs
ROHS compliant	yes ⓘ



MATERIAL SPECIFICATIONS:

Component	Type	Material	Colour
STRADA-SQ-T3	Lens	PMMA	clear
ROSE-TAPE	Tape	PU tape	black

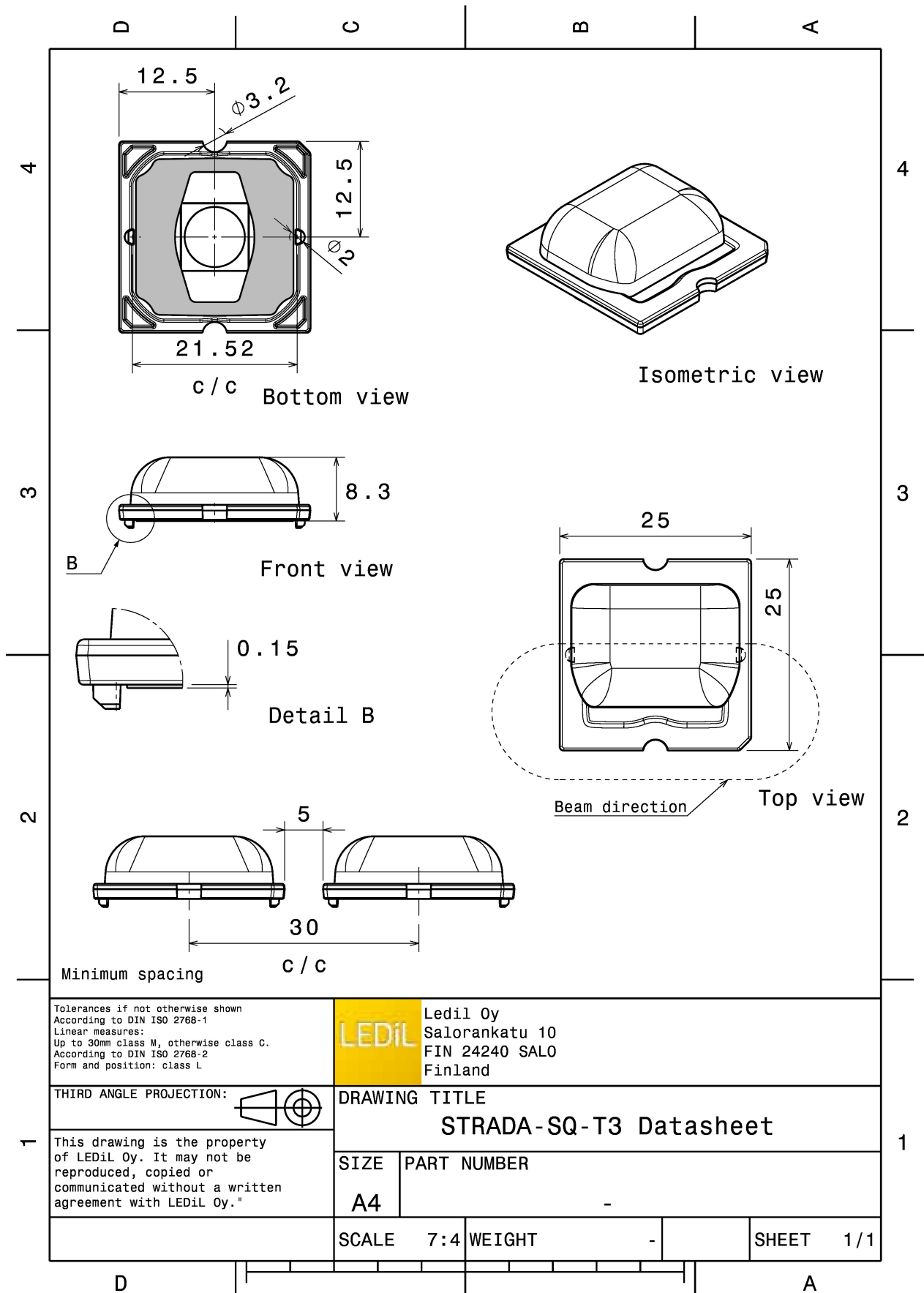

PHOTOMETRIC DATA (MEASURED):

CITIZEN

LED PSL440
FWHM Asymmetric
Efficiency 92 %
Peak intensity 0.730 cd/lm
Required components:

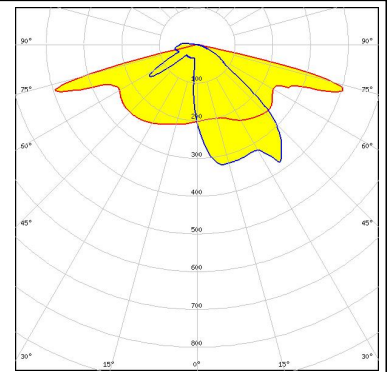
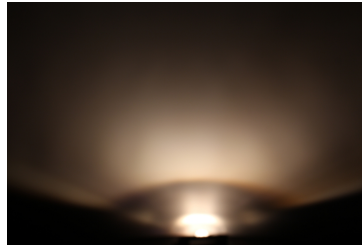

CREE

LED XHP50
FWHM Asymmetric
Efficiency 94 %
Peak intensity 0.710 cd/lm
Required components:

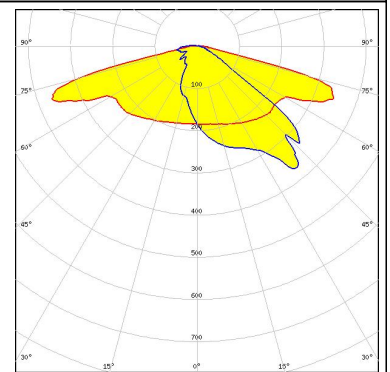

LUMILEDS

LED LUXEON M/MX
FWHM Asymmetric
Efficiency 92 %
Peak intensity 0.500 cd/lm
Required components:

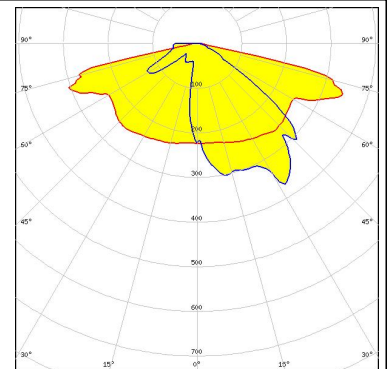

LUMILEDS

LED LUXEON MZ
FWHM Asymmetric
Efficiency 91 %
Peak intensity 0.840 cd/lm
Required components:

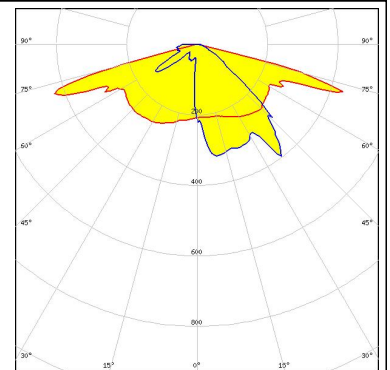

PHOTOMETRIC DATA (MEASURED):

LUMILEDS

LED LUXEON TX
FWHM Asymmetric
Efficiency 93 %
Peak intensity 1.100 cd/lm
Required components:

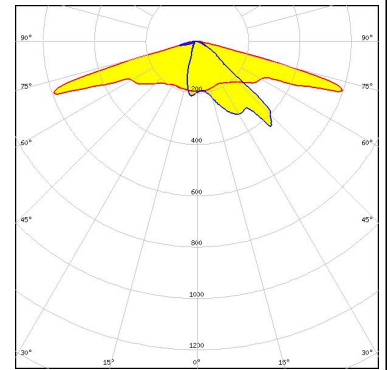

LUMILEDS

LED LUXEON XR-M linear 1x3, 1x4, 1x5
FWHM Asymmetric
Efficiency 93 %
Peak intensity 0.530 cd/lm
Required components:

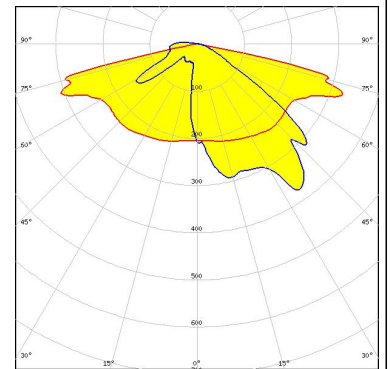

NICHIA

LED NV4x144A
FWHM Asymmetric
Efficiency 91 %
Peak intensity 0.550 cd/lm
Required components:

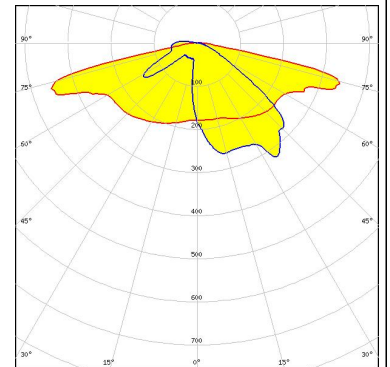

OSRAM Opto Semiconductors

LED Duris S10
FWHM Asymmetric
Efficiency 92 %
Peak intensity 0.590 cd/lm
Required components:

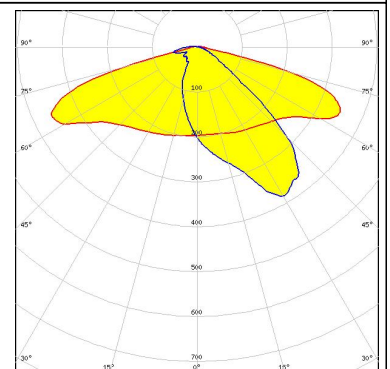

PHOTOMETRIC DATA (SIMULATED):



LED MHB-A/B
FWHM Asymmetric
Efficiency 89 %
Peak intensity 0.530 cd/lm
Required components:

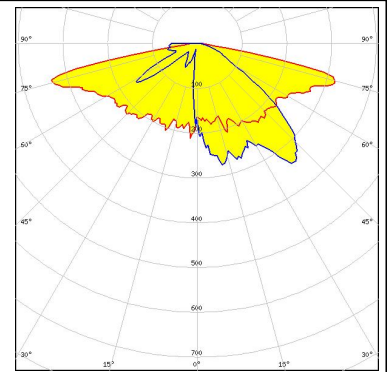

LED MK-R
FWHM Asymmetric
Efficiency 90 %
Peak intensity 0.550 cd/lm
Required components:

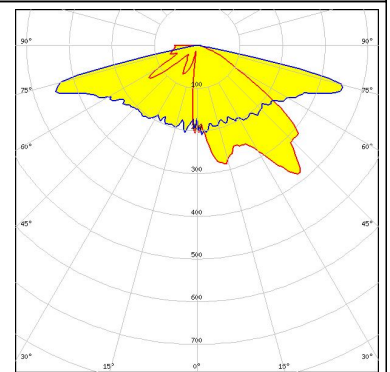

LED XP-G3
FWHM Asymmetric
Efficiency 89 %
Peak intensity 0.780 cd/lm
Required components:

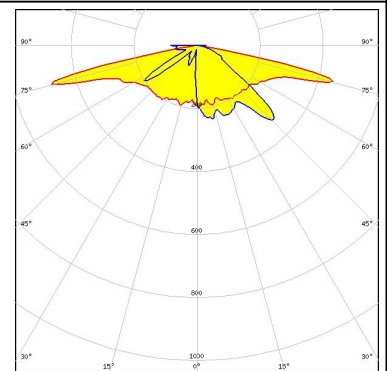

LED NVSxx19B/NVSxx19C
FWHM Asymmetric
Efficiency 90 %
Peak intensity cd/lm
Required components:

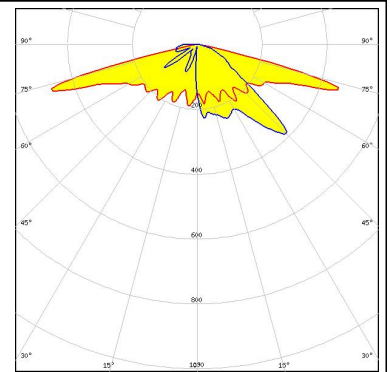

PHOTOMETRIC DATA (SIMULATED):

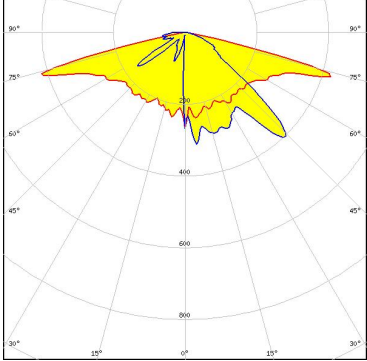
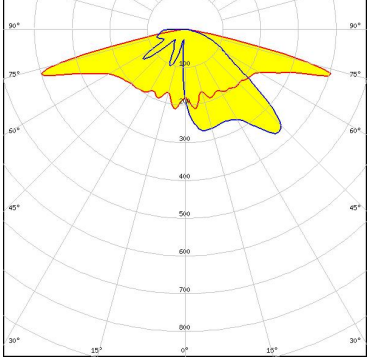
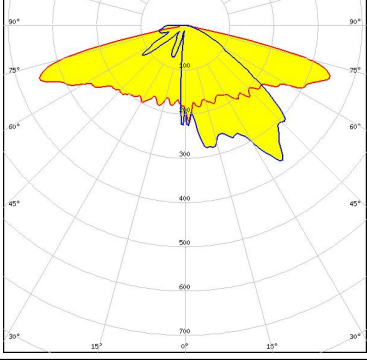
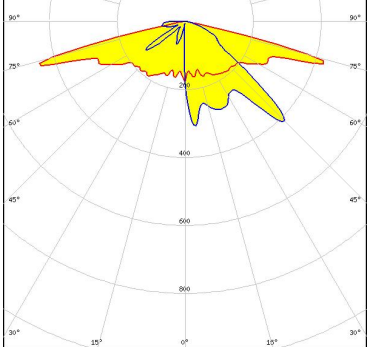
<p>OSRAM Opto Semiconductors</p> <p>LED OSCONIQ P 3737 (2W version)</p> <p>FWHM Asymmetric</p> <p>Efficiency 91 %</p> <p>Peak intensity 0.780 cd/lm</p> <p>Required components:</p>	
<p>OSRAM Opto Semiconductors</p> <p>LED OSCONIQ P 3737 (3W version)</p> <p>FWHM Asymmetric</p> <p>Efficiency 94 %</p> <p>Peak intensity 0.650 cd/lm</p> <p>Required components:</p>	
<p>OSRAM Opto Semiconductors</p> <p>LED OSCONIQ P 7070</p> <p>FWHM Asymmetric</p> <p>Efficiency 89 %</p> <p>Peak intensity 0.640 cd/lm</p> <p>Required components:</p>	
<p>OSRAM Opto Semiconductors</p> <p>LED Oslon Square Gen3</p> <p>FWHM Asymmetric</p> <p>Efficiency 91 %</p> <p>Peak intensity 0.810 cd/lm</p> <p>Required components:</p>	

GENERAL INFORMATION:

NOTE: The typical beam angle will be changed by different color, chip size and chip position tolerance. The typical total beam angle is the full angle measured where the luminous intensity is half of the peak value.

MATERIALS:

As part of our continuous research and improvement processes, and to ensure the best possible quality and availability of our products, LEDiL reserves the right to change material grades without notice.

PRODUCT DATA USER AGREEMENT AND DISCLAIMER:

The measured data in the provided downloadable LEDiL Product Datasheets and Mechanical 2D-Drawings is rounded and provided as reference for planning. LEDiL Oy's optical specifications have been verified by conducting performance testing of the products in accordance with the company's quality system. The reported data are averaged results of multiple measurements with typical variation. LEDiL Oy reserves the right to without prior notification make changes and improvements to its products.

LEDiL Oy assumes neither warranty, nor guarantee nor any other liability of any kind for the contents and correctness of the provided data. The provided data has been generated with highest diligence but the provided data may in reality not represent the complete possible variation range of all intrinsic parameters. Therefore, in certain cases a deviation from the provided data could occur.

LEDiL Oy reserves the right to undertake technical changes of its products without further notification which could lead to changes in the provided data. LEDiL Oy assumes no liability of any kind for the possible deviation from any provided data or any other damage resulting from the usage of the provided data.

The user agrees to this disclaimer and user agreement with the download or usage of the provided files.

LEDiL Oy

Joensuunkatu 13
FI-24240 SALO
Finland

LEDiL Inc.

228 West Page Street
Suite D
Sycamore IL 60178
USA

Local sales and technical support

[www.ledil.com/
where_to_buy](http://www.ledil.com/where_to_buy)

Shipping locations

Salo, Finland
Hong Kong, China

Distribution Partners

[www.ledil.com/
where_to_buy](http://www.ledil.com/where_to_buy)