



Chipsmall Limited consists of a professional team with an average of over 10 year of expertise in the distribution of electronic components. Based in Hongkong, we have already established firm and mutual-benefit business relationships with customers from,Europe,America and south Asia,supplying obsolete and hard-to-find components to meet their specific needs.

With the principle of “Quality Parts,Customers Priority,Honest Operation,and Considerate Service”,our business mainly focus on the distribution of electronic components. Line cards we deal with include Microchip,ALPS,ROHM,Xilinx,Pulse,ON,Everlight and Freescale. Main products comprise IC,Modules,Potentiometer,IC Socket,Relay,Connector.Our parts cover such applications as commercial,industrial, and automotives areas.

We are looking forward to setting up business relationship with you and hope to provide you with the best service and solution. Let us make a better world for our industry!



Contact us

Tel: +86-755-8981 8866 Fax: +86-755-8427 6832

Email & Skype: info@chipsmall.com Web: www.chipsmall.com

Address: A1208, Overseas Decoration Building, #122 Zhenhua RD., Futian, Shenzhen, China



STRADA-SQ-FS

Forward throw beam for area lighting. Version with location pins. Assembly with installation tape.

TECHNICAL SPECIFICATIONS:

Dimensions	25.0 mm
Height	12.6 mm
Fastening	tape, pin
Colour	clear
Box size	480 x 280 x 300 mm
Box weight	6.5 kg
Quantity in Box	1568 pcs
ROHS compliant	yes ⓘ

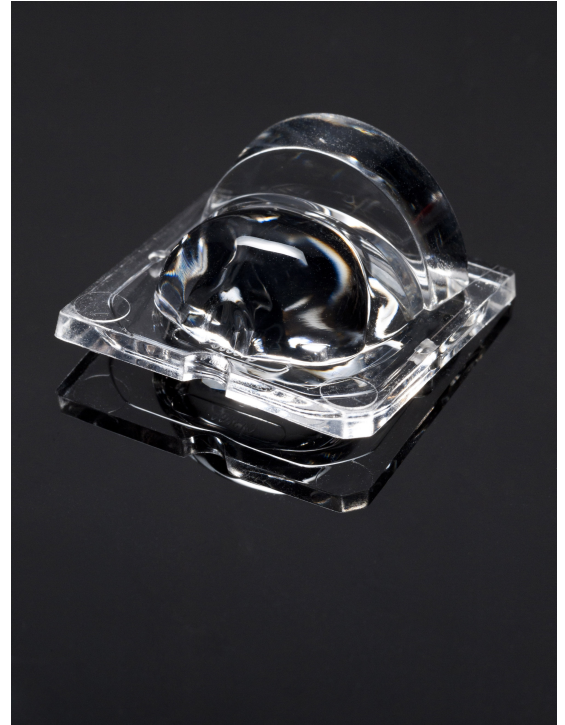

MATERIAL SPECIFICATIONS:

Component	Type	Material	Colour
STRADA-SQ-FS	Lens	PMMA	clear
ROSE-TAPE	Tape	PU tape	black

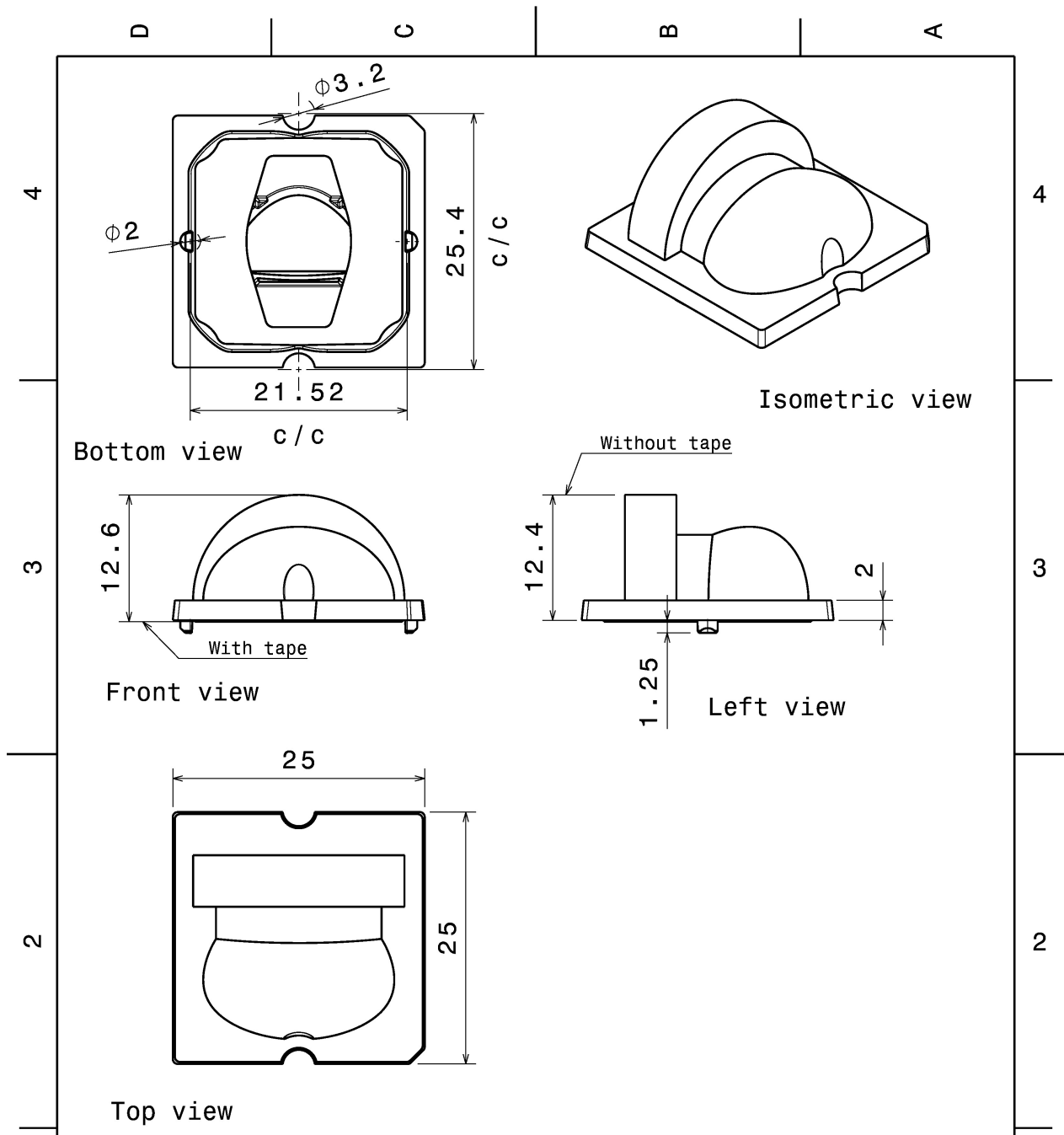

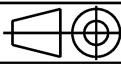
<p>Tolerances if not otherwise shown According to DIN ISO 2768-1 Linear measures: Up to 30mm class M, otherwise class C. According to DIN ISO 2768-2 Form and position: class L</p> <p>THIRD ANGLE PROJECTION: </p> <p>This drawing is the property of LEDiL Oy. It may not be reproduced, copied or communicated without a written agreement with LEDiL Oy."</p>	LEDiL		Ledil Oy Salorankatu 10 FIN 24240 SALO Finland	
	DRAWING TITLE			
	STRADA - SQ - FS			
	SIZE	PART NUMBER		
A4	-			
SCALE	2:1	WEIGHT	- g	SHEET 1/1

PHOTOMETRIC DATA (MEASURED):

CITIZEN

LED PSL440
FWHM Asymmetric
Efficiency 93 %
Peak intensity 1.080 cd/lm
Required components:

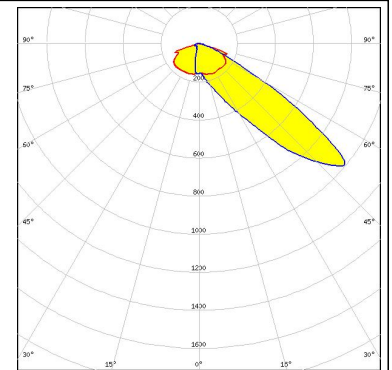

CITIZEN

LED PSL445
FWHM Asymmetric
Efficiency 92 %
Peak intensity 0.760 cd/lm
Required components:

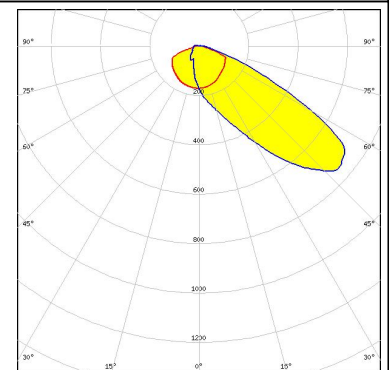

CREE

LED MK-R
FWHM Asymmetric
Efficiency 93 %
Peak intensity 0.900 cd/lm
Required components:

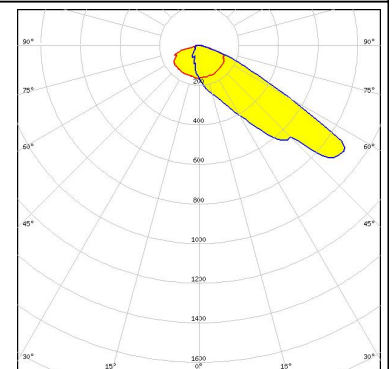

CREE

LED XHP50
FWHM Asymmetric
Efficiency 93 %
Peak intensity 0.920 cd/lm
Required components:

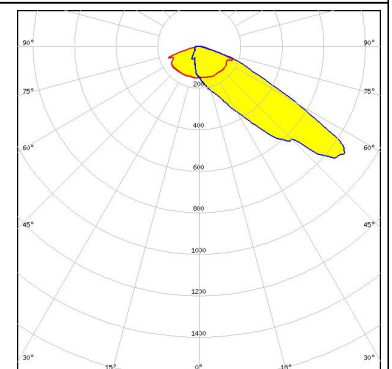

PHOTOMETRIC DATA (MEASURED):



LED XHP70

FWHM Asymmetric

Efficiency 80 %

Peak intensity 0.620 cd/lm

Required components:

Undefined Manufacturer: Protective Plate, Glass

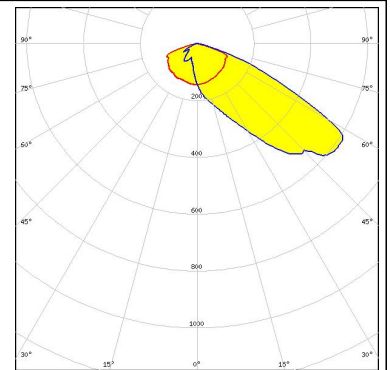

LED XM-L

FWHM Asymmetric

Efficiency 93 %

Peak intensity 1.200 cd/lm

Required components:

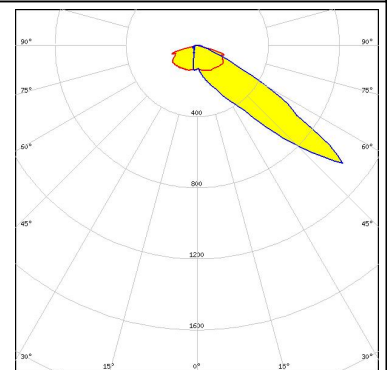

LED XP-L

FWHM Asymmetric

Efficiency 93 %

Peak intensity 1.100 cd/lm

Required components:

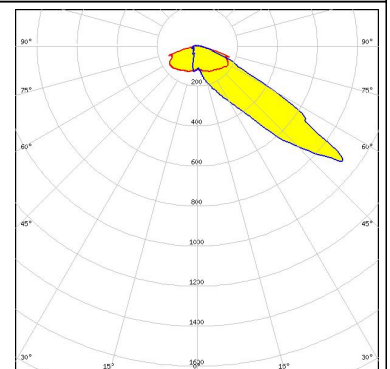

LED XT-E

FWHM Asymmetric

Efficiency 93 %

Peak intensity 1.200 cd/lm

Required components:

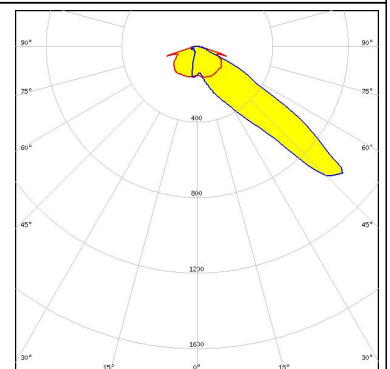

PHOTOMETRIC DATA (MEASURED):

LUMILEDS

LED LUXEON M/MX
 FWHM Asymmetric
 Efficiency 92 %
 Peak intensity 0.900 cd/lm
 Required components:

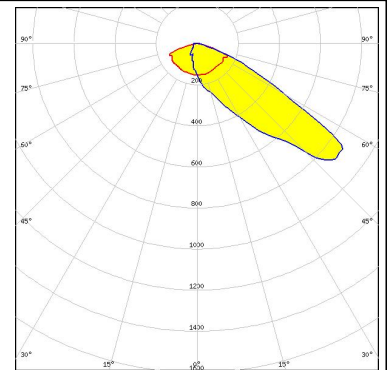

LUMILEDS

LED LUXEON MZ
 FWHM Asymmetric
 Efficiency 94 %
 Peak intensity 1.200 cd/lm
 Required components:

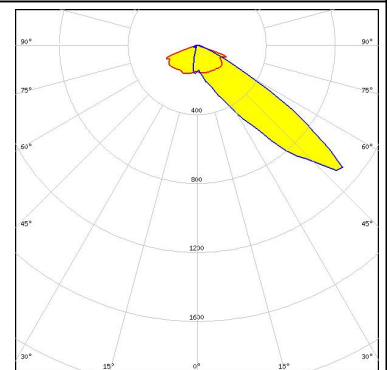

LUMILEDS

LED LUXEON XR-M linear 1x3, 1x4, 1x5
 FWHM Asymmetric
 Efficiency 94 %
 Peak intensity 0.970 cd/lm
 Required components:

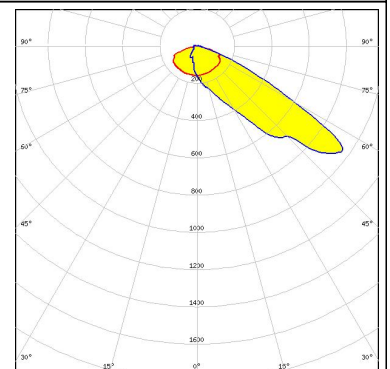

OSRAM Opto Semiconductors

LED Duris S10
 FWHM Asymmetric
 Efficiency 91 %
 Peak intensity 0.860 cd/lm
 Required components:

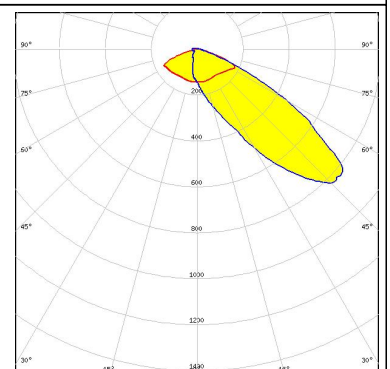

PHOTOMETRIC DATA (SIMULATED):



LED MHB-A/B
FWHM Asymmetric
Efficiency %
Peak intensity cd/lm
Required components:

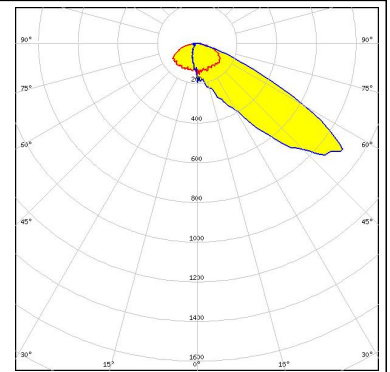

LED XHP35 HD
FWHM Asymmetric
Efficiency 92 %
Peak intensity 1.010 cd/lm
Required components:

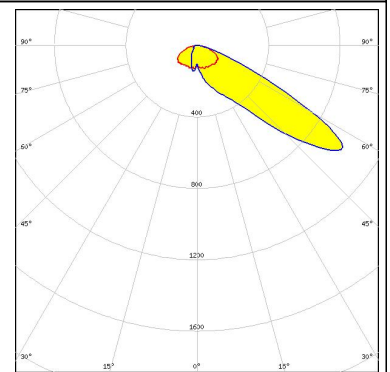

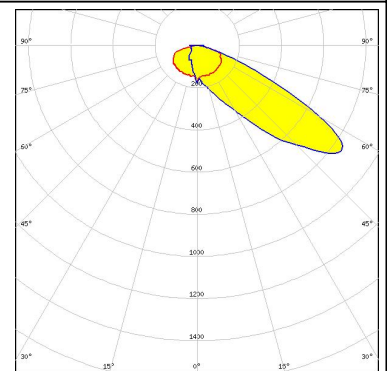

LED XHP50.2
FWHM 71.0 + 30.0°
Efficiency 93 %
Peak intensity 0.850 cd/lm
Required components:

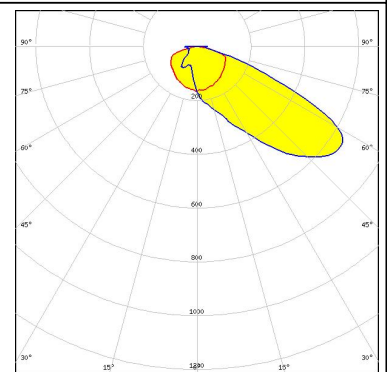

LED XHP70.2
FWHM Asymmetric
Efficiency 91 %
Peak intensity 0.650 cd/lm
Required components:



PHOTOMETRIC DATA (SIMULATED):

<p> LED LUXEON M/MX FWHM Asymmetric Efficiency 81 % Peak intensity 0.820 cd/lm Required components: Undefined Manufacturer: Protective Plate, Glass</p>	
<p> LED OSCONIQ P 7070 FWHM Asymmetric Efficiency 90 % Peak intensity 1.000 cd/lm Required components:</p>	
<p> LED Z8Y50P FWHM Asymmetric Efficiency 93 % Peak intensity 0.840 cd/lm Required components:</p>	

GENERAL INFORMATION:

NOTE: The typical beam angle will be changed by different color, chip size and chip position tolerance. The typical total beam angle is the full angle measured where the luminous intensity is half of the peak value.

MATERIALS:

As part of our continuous research and improvement processes, and to ensure the best possible quality and availability of our products, LEDiL reserves the right to change material grades without notice.

PRODUCT DATA USER AGREEMENT AND DISCLAIMER:

The measured data in the provided downloadable LEDiL Product Datasheets and Mechanical 2D-Drawings is rounded and provided as reference for planning. LEDiL Oy's optical specifications have been verified by conducting performance testing of the products in accordance with the company's quality system. The reported data are averaged results of multiple measurements with typical variation. LEDiL Oy reserves the right to without prior notification make changes and improvements to its products.

LEDiL Oy assumes neither warranty, nor guarantee nor any other liability of any kind for the contents and correctness of the provided data. The provided data has been generated with highest diligence but the provided data may in reality not represent the complete possible variation range of all intrinsic parameters. Therefore, in certain cases a deviation from the provided data could occur.

LEDiL Oy reserves the right to undertake technical changes of its products without further notification which could lead to changes in the provided data. LEDiL Oy assumes no liability of any kind for the possible deviation from any provided data or any other damage resulting from the usage of the provided data.

The user agrees to this disclaimer and user agreement with the download or usage of the provided files.

LEDiL Oy

Joensuunkatu 13
FI-24240 SALO
Finland

LEDiL Inc.

228 West Page Street
Suite D
Sycamore IL 60178
USA

Local sales and technical support

[www.ledil.com/
where_to_buy](http://www.ledil.com/where_to_buy)

Shipping locations

Salo, Finland
Hong Kong, China

Distribution Partners

[www.ledil.com/
where_to_buy](http://www.ledil.com/where_to_buy)