



Chipsmall Limited consists of a professional team with an average of over 10 year of expertise in the distribution of electronic components. Based in Hongkong, we have already established firm and mutual-benefit business relationships with customers from,Europe,America and south Asia,supplying obsolete and hard-to-find components to meet their specific needs.

With the principle of “Quality Parts,Customers Priority,Honest Operation,and Considerate Service”,our business mainly focus on the distribution of electronic components. Line cards we deal with include Microchip,ALPS,ROHM,Xilinx,Pulse,ON,Everlight and Freescale. Main products comprise IC,Modules,Potentiometer,IC Socket,Relay,Connector.Our parts cover such applications as commercial,industrial, and automotives areas.

We are looking forward to setting up business relationship with you and hope to provide you with the best service and solution. Let us make a better world for our industry!



Contact us

Tel: +86-755-8981 8866 Fax: +86-755-8427 6832

Email & Skype: info@chipsmall.com Web: www.chipsmall.com

Address: A1208, Overseas Decoration Building, #122 Zhenhua RD., Futian, Shenzhen, China



VERONICA-SQ-M

~30° medium beam

TECHNICAL SPECIFICATIONS:

Dimensions	22.5x22.5 mm
Height	11.8 mm
Fastening	tape, pin
Colour	clear
Box size	476 x 273 x 197 mm
Box weight	8.2 kg
Quantity in Box	1980 pcs
ROHS compliant	yes ⓘ

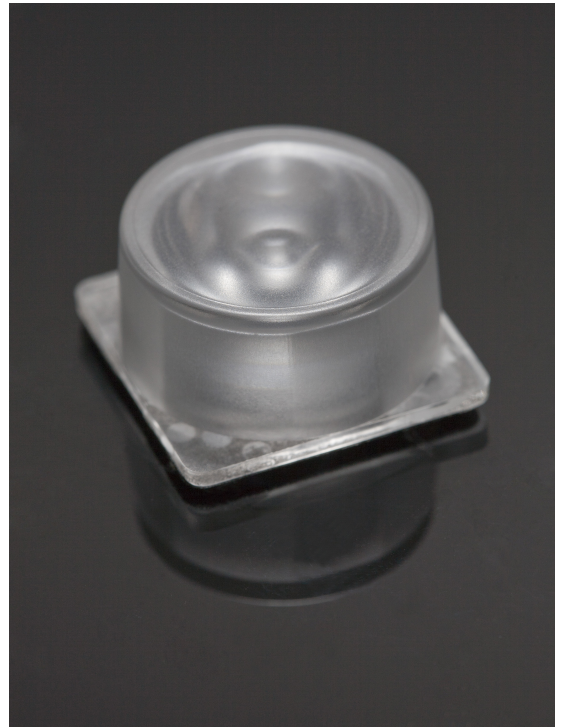

MATERIAL SPECIFICATIONS:

Component	Type	Material	Colour
VERONICA-SQ-M	Lens	PMMA	clear
VERONICA-TAPE	Tape	PU tape	clear

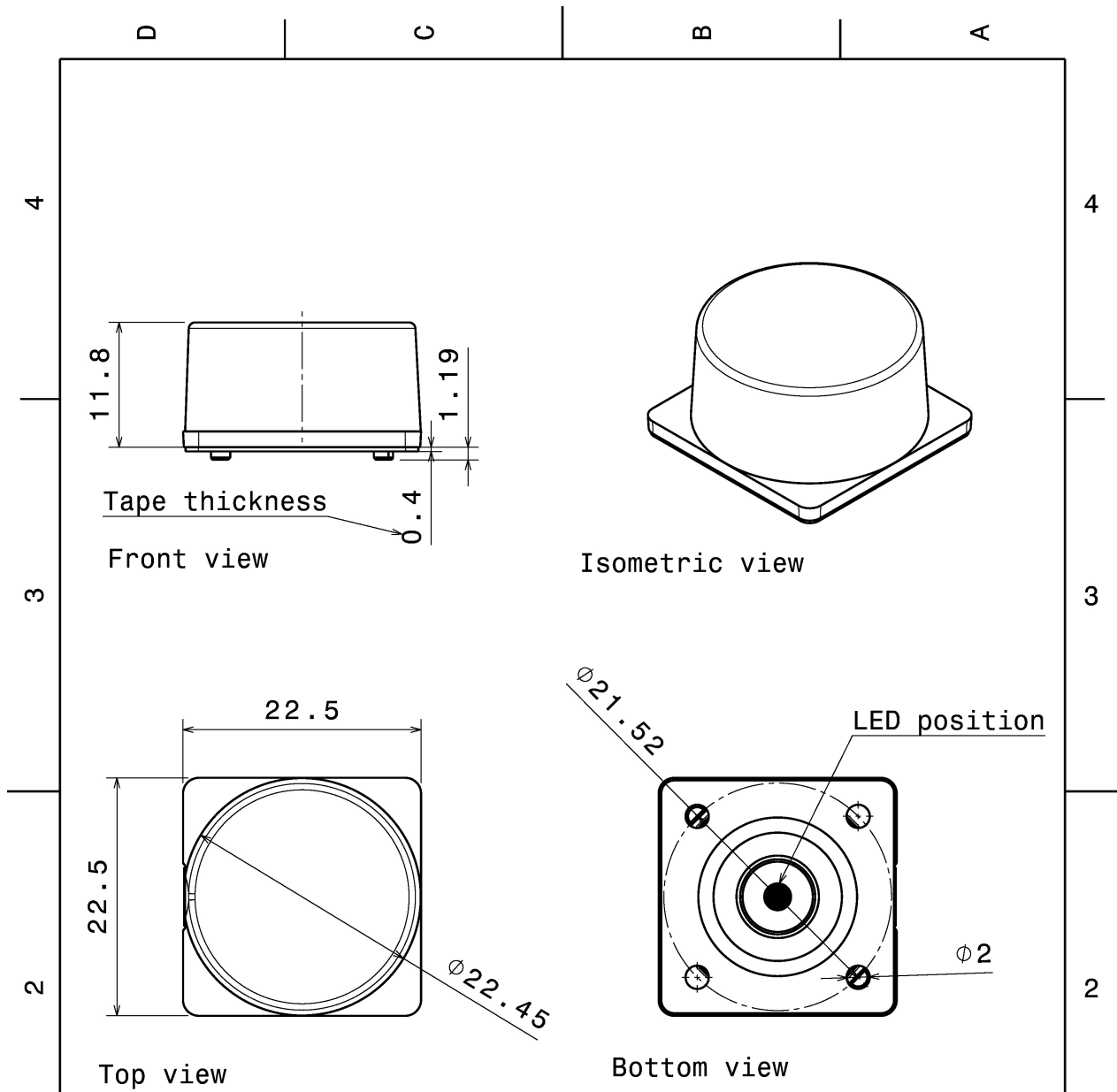

INDEX	PART NO	DESCRIPTION	MATERIAL	COLOUR
1	C14448	VERONICA-SQ-M	PMMA	clear
2	C13729	VERONICA-SQ-TAPE	PU	black

Tolerances if not otherwise shown
According to DIN ISO 2768-1
Linear measures: class C
According to DIN ISO 2768-2
Form and position: class L

LEDiL

Ledil Oy
Salorankatu 10
FIN 24240 SALO
Finland

THIRD ANGLE PROJECTION:

DRAWING TITLE
CA14461_VERONICA-SQ-M

This drawing is the property of LEDiL Oy. It may not be reproduced, copied or communicated without a written agreement with LEDiL Oy.

SIZE	PART NUMBER
A4	CA14461

SCALE	2:1	WEIGHT	3,64 g	SHEET	1/1
-------	-----	--------	--------	-------	-----

PHOTOMETRIC DATA (MEASURED):



LED XB-H
FWHM 29.0°
Efficiency 91 %
Peak intensity 3.000 cd/lm
Required components:

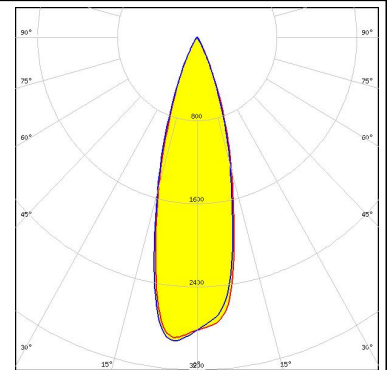

LED XHP35 HD
FWHM 40.0°
Efficiency 88 %
Peak intensity 1.900 cd/lm
Required components:

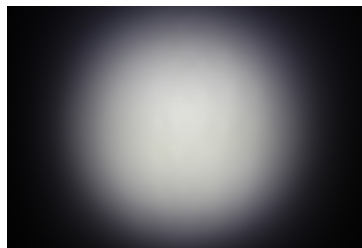

LED XHP35 HI
FWHM 33.0°
Efficiency 88 %
Peak intensity 2.700 cd/lm
Required components:

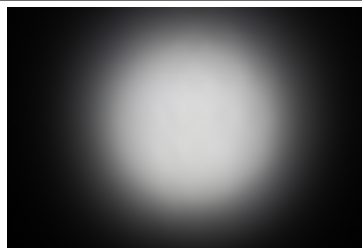

LED XM-L
FWHM 37.0°
Efficiency 92 %
Peak intensity 2.100 cd/lm
Required components:

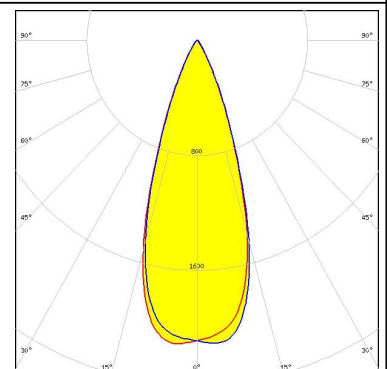
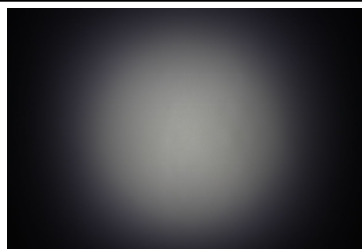

PHOTOMETRIC DATA (MEASURED):



LED XM-L2
FWHM 38.0°
Efficiency 91 %
Peak intensity 2.100 cd/lm
Required components:

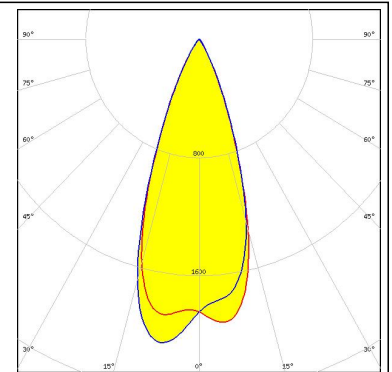
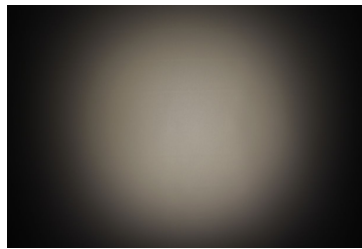

LED XP-E
FWHM 28.0°
Efficiency 93 %
Peak intensity 3.600 cd/lm
Required components:

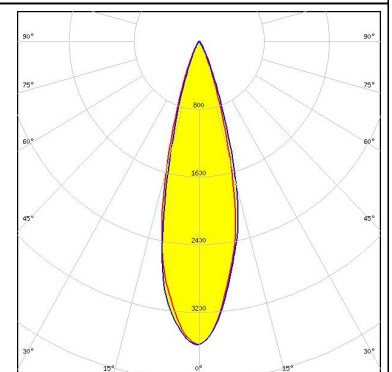
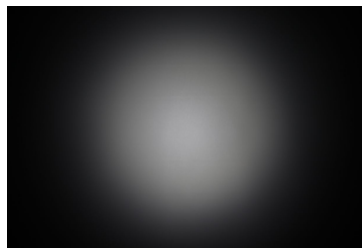

LED XP-E2
FWHM 25.0°
Efficiency 94 %
Peak intensity 4.200 cd/lm
Required components:

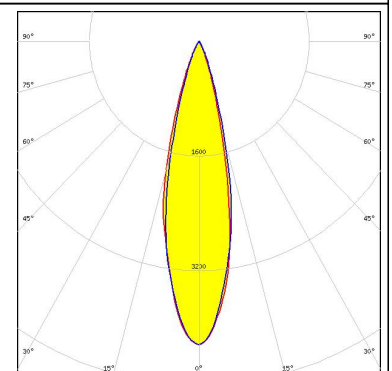
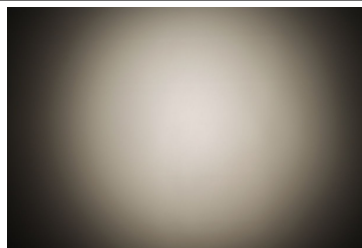

LED XP-G2
FWHM 30.0°
Efficiency 89 %
Peak intensity 3.060 cd/lm
Required components:

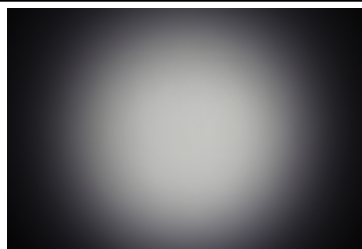

PHOTOMETRIC DATA (MEASURED):



LED XP-L
 FWHM 40.0°
 Efficiency 91 %
 Peak intensity 2.000 cd/lm
 Required components:

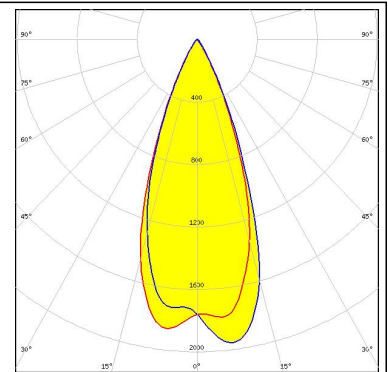
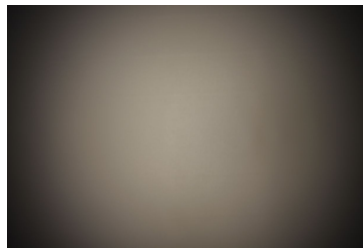

LED XP-L2
 FWHM 37.0°
 Efficiency 87 %
 Peak intensity 2.000 cd/lm
 Required components:

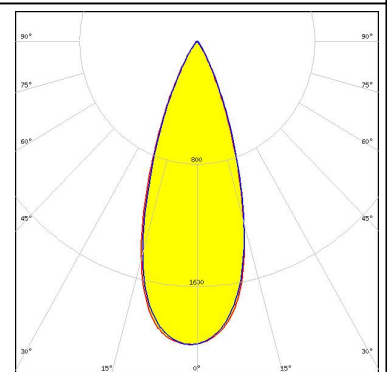
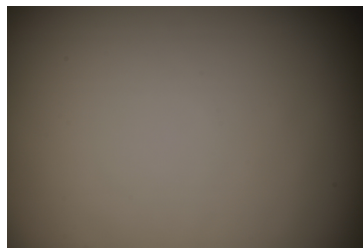

LED XT-E
 FWHM 27.0°
 Efficiency 87 %
 Peak intensity 3.500 cd/lm
 Required components:

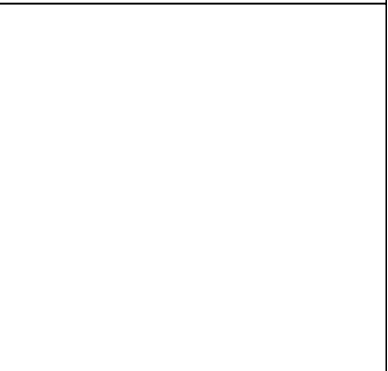
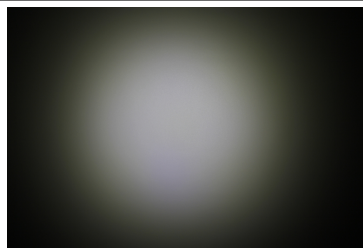

LED H35C1 (LEMWA33)
 FWHM 33.0°
 Efficiency 92 %
 Peak intensity 2.700 cd/lm
 Required components:

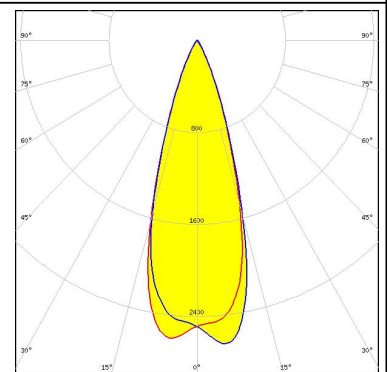
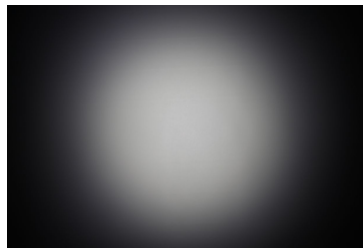

PHOTOMETRIC DATA (MEASURED):

LUMILEDS

LED LUXEON 3030 2D (Round LES)
FWHM 24.0°
Efficiency 94 %
Peak intensity 4.500 cd/lm
Required components:

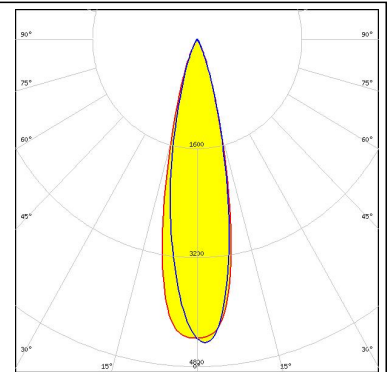
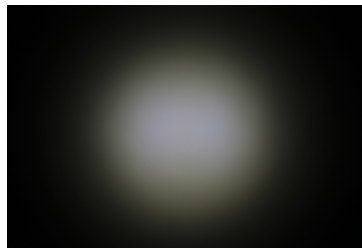

LUMILEDS

LED LUXEON A
FWHM 30.0°
Efficiency 91 %
Peak intensity 3.000 cd/lm
Required components:

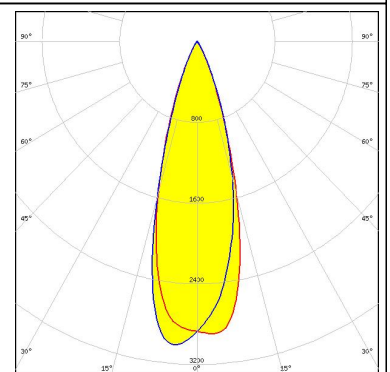
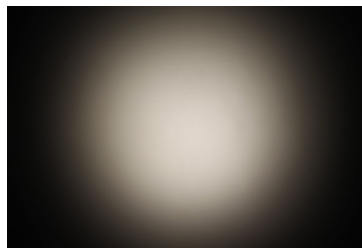

LUMILEDS

LED LUXEON MZ
FWHM 32.0°
Efficiency 93 %
Peak intensity 2.700 cd/lm
Required components:

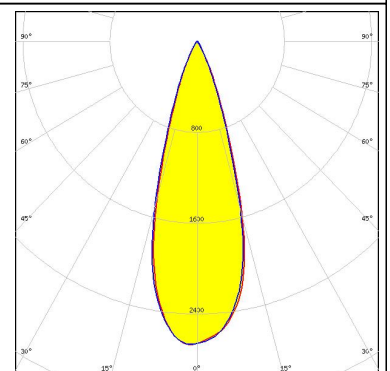
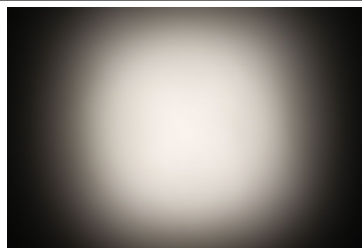

LUMILEDS

LED LUXEON R
FWHM 30.0°
Efficiency 91 %
Peak intensity 3.000 cd/lm
Required components:

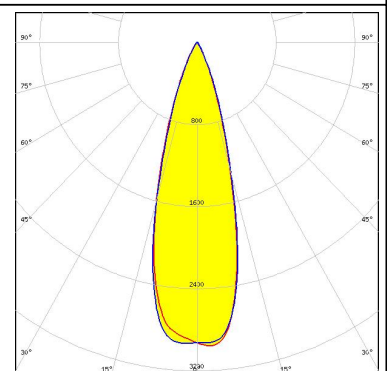
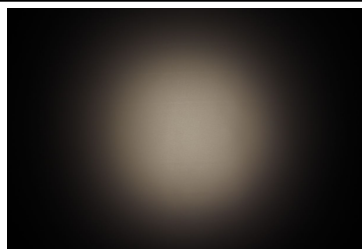

PHOTOMETRIC DATA (MEASURED):

LUMILEDS

LED LUXEON Rebel
 FWHM 26.0°
 Efficiency 92 %
 Peak intensity 3.600 cd/lm
 Required components:

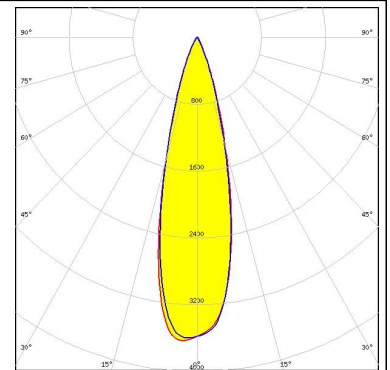
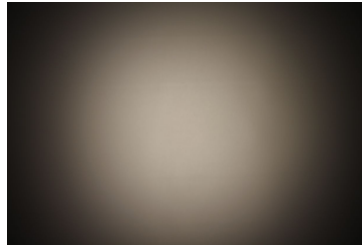

LUMILEDS

LED LUXEON Rebel ES
 FWHM 27.0°
 Efficiency 91 %
 Peak intensity 3.500 cd/lm
 Required components:

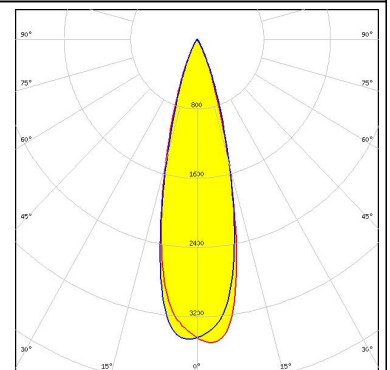
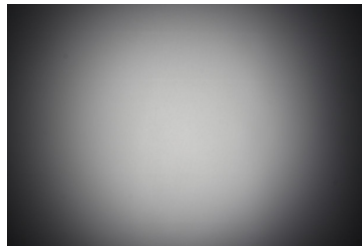

LUMILEDS

LED LUXEON T
 FWHM 30.0°
 Efficiency 93 %
 Peak intensity 3.000 cd/lm
 Required components:

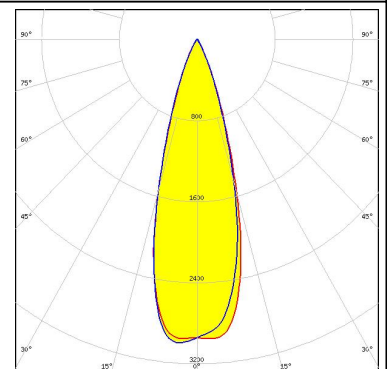
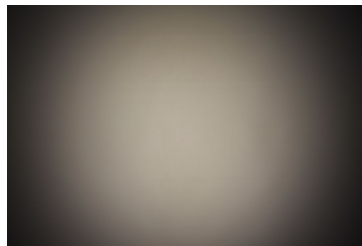

LUMILEDS

LED LUXEON TX
 FWHM 30.0°
 Efficiency 92 %
 Peak intensity 3.200 cd/lm
 Required components:

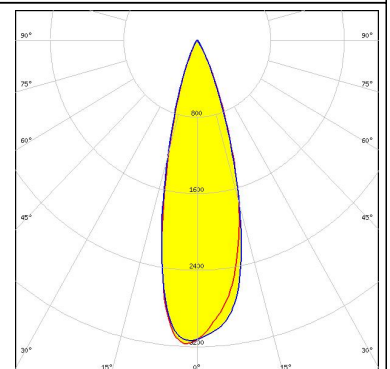
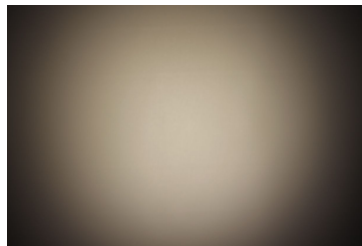

PHOTOMETRIC DATA (MEASURED):



LED LUXEON V
 FWHM 35.0°
 Efficiency 90 %
 Peak intensity 2.300 cd/lm
 Required components:

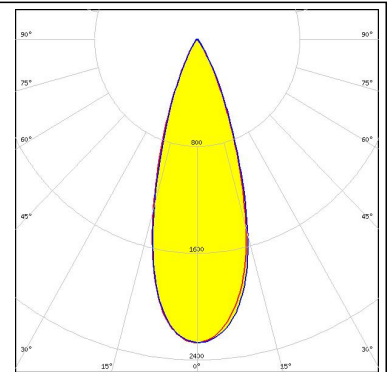
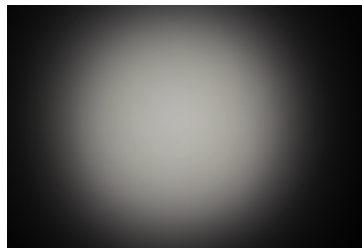

LED NCSxx19B
 FWHM 23.0°
 Efficiency 92 %
 Peak intensity 4.100 cd/lm
 Required components:

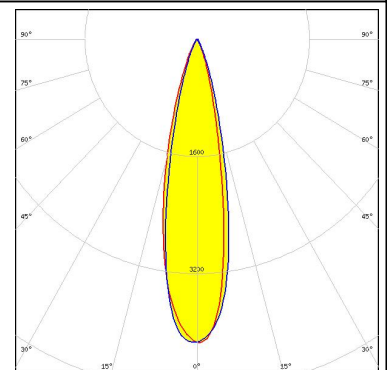
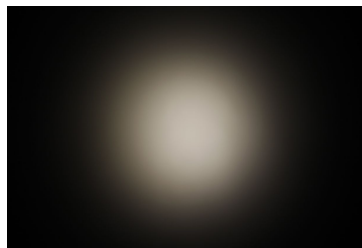

LED NVSxx19B/NVSxx19C
 FWHM 30.0°
 Efficiency 91 %
 Peak intensity 2.900 cd/lm
 Required components:

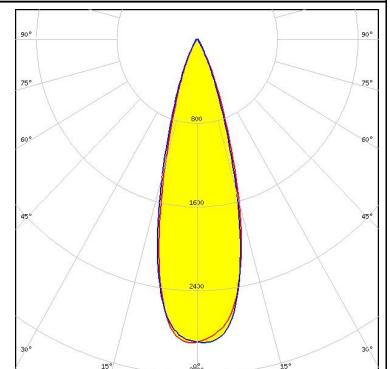
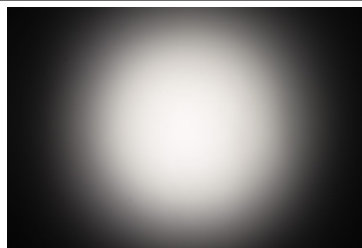

LED NWSx229A
 FWHM 39.0°
 Efficiency 89 %
 Peak intensity 2.000 cd/lm
 Required components:

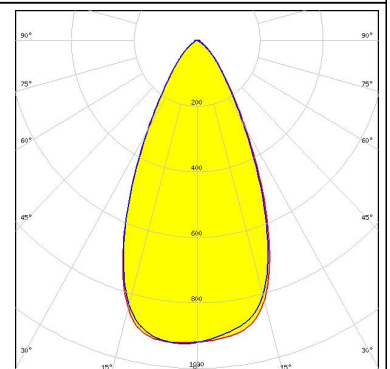
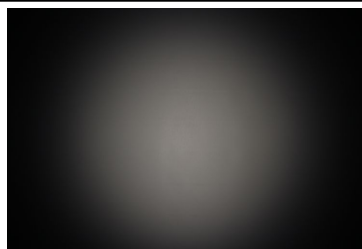

PHOTOMETRIC DATA (MEASURED):

OSRAM
Opto Semiconductors

LED Oslon Square EC
FWHM 28.0°
Efficiency 91 %
Peak intensity 3.400 cd/lm
Required components:

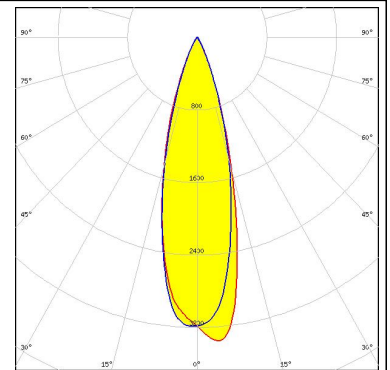
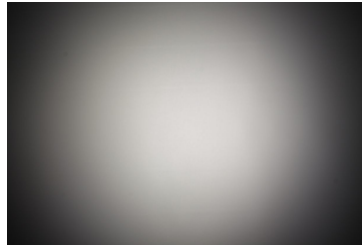

OSRAM
Opto Semiconductors

LED Oslon Square PC
FWHM 29.0°
Efficiency 91 %
Peak intensity 3.000 cd/lm
Required components:

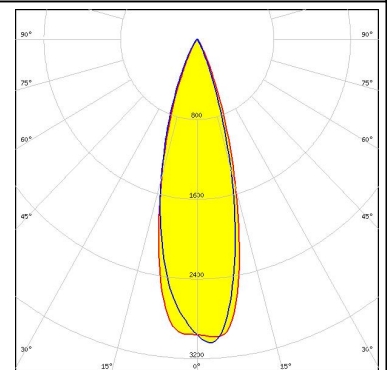
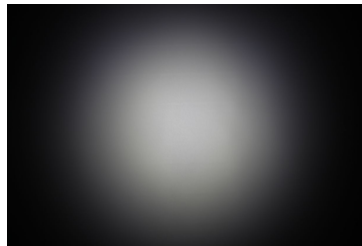

SAMSUNG

LED LH181A
FWHM 21.0°
Efficiency 94 %
Peak intensity 4.300 cd/lm
Required components:

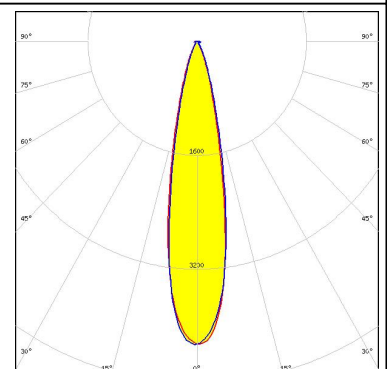
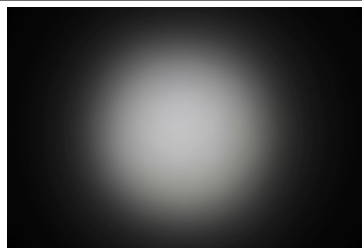

SAMSUNG

LED LH181B
FWHM 23.0°
Efficiency 94 %
Peak intensity 4.500 cd/lm
Required components:

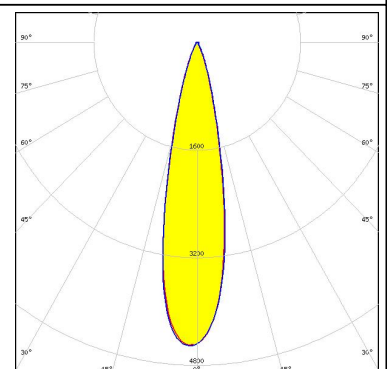
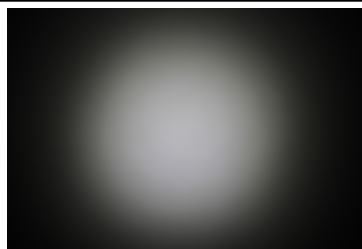

PHOTOMETRIC DATA (MEASURED):



PHOTOMETRIC DATA (SIMULATED):

LUMILEDS

LED LUXEON C
FWHM 29.0°
Efficiency 94 %
Peak intensity 3.700 cd/lm
Required components:

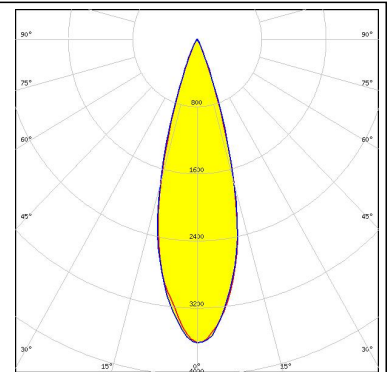

SAMSUNG

LED LM28xB Series
FWHM 29.0°
Efficiency 94 %
Peak intensity 3.450 cd/lm
Required components:

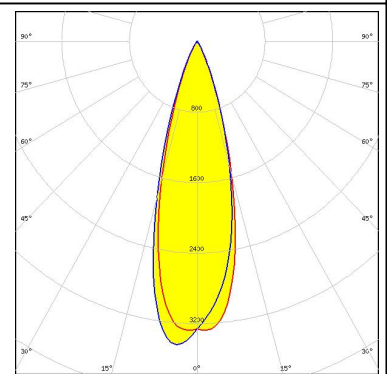

GENERAL INFORMATION:

NOTE: The typical beam angle will be changed by different color, chip size and chip position tolerance. The typical total beam angle is the full angle measured where the luminous intensity is half of the peak value.

MATERIALS:

As part of our continuous research and improvement processes, and to ensure the best possible quality and availability of our products, LEDiL reserves the right to change material grades without notice.

PRODUCT DATA USER AGREEMENT AND DISCLAIMER:

The measured data in the provided downloadable LEDiL Product Datasheets and Mechanical 2D-Drawings is rounded and provided as reference for planning. LEDiL Oy's optical specifications have been verified by conducting performance testing of the products in accordance with the company's quality system. The reported data are averaged results of multiple measurements with typical variation. LEDiL Oy reserves the right to without prior notification make changes and improvements to its products.

LEDiL Oy assumes neither warranty, nor guarantee nor any other liability of any kind for the contents and correctness of the provided data. The provided data has been generated with highest diligence but the provided data may in reality not represent the complete possible variation range of all intrinsic parameters. Therefore, in certain cases a deviation from the provided data could occur.

LEDiL Oy reserves the right to undertake technical changes of its products without further notification which could lead to changes in the provided data. LEDiL Oy assumes no liability of any kind for the possible deviation from any provided data or any other damage resulting from the usage of the provided data.

The user agrees to this disclaimer and user agreement with the download or usage of the provided files.

LEDiL Oy

Joensuunkatu 13
FI-24240 SALO
Finland

LEDiL Inc.

228 West Page Street
Suite D
Sycamore IL 60178
USA

Local sales and technical support

[www.ledil.com/
where_to_buy](http://www.ledil.com/where_to_buy)

Shipping locations

Salo, Finland
Hong Kong, China

Distribution Partners

[www.ledil.com/
where_to_buy](http://www.ledil.com/where_to_buy)