



Chipsmall Limited consists of a professional team with an average of over 10 year of expertise in the distribution of electronic components. Based in Hongkong, we have already established firm and mutual-benefit business relationships with customers from,Europe,America and south Asia,supplying obsolete and hard-to-find components to meet their specific needs.

With the principle of “Quality Parts,Customers Priority,Honest Operation,and Considerate Service”,our business mainly focus on the distribution of electronic components. Line cards we deal with include Microchip,ALPS,ROHM,Xilinx,Pulse,ON,Everlight and Freescale. Main products comprise IC,Modules,Potentiometer,IC Socket,Relay,Connector.Our parts cover such applications as commercial,industrial, and automotives areas.

We are looking forward to setting up business relationship with you and hope to provide you with the best service and solution. Let us make a better world for our industry!



Contact us

Tel: +86-755-8981 8866 Fax: +86-755-8427 6832

Email & Skype: info@chipsmall.com Web: www.chipsmall.com

Address: A1208, Overseas Decoration Building, #122 Zhenhua RD., Futian, Shenzhen, China



STRADA-SQ-FS3

Forward throw beam optimized for European tunnels, resulting extremely efficient lighting with counter-beam method. Version with location pins. Assembly with installation tape.

TECHNICAL SPECIFICATIONS:

Dimensions	25 + 25 mm
Height	16.2 mm
Fastening	tape
Colour	clear
Box size	480 x 280 x 300 mm
Box weight	7.4 kg
Quantity in Box	1470 pcs
ROHS compliant	yes ⓘ



MATERIAL SPECIFICATIONS:

Component	Type	Material	Colour
STRADA-SQ-FS3	Lens	PMMA	clear
ROSE-TAPE	Tape	PU tape	black

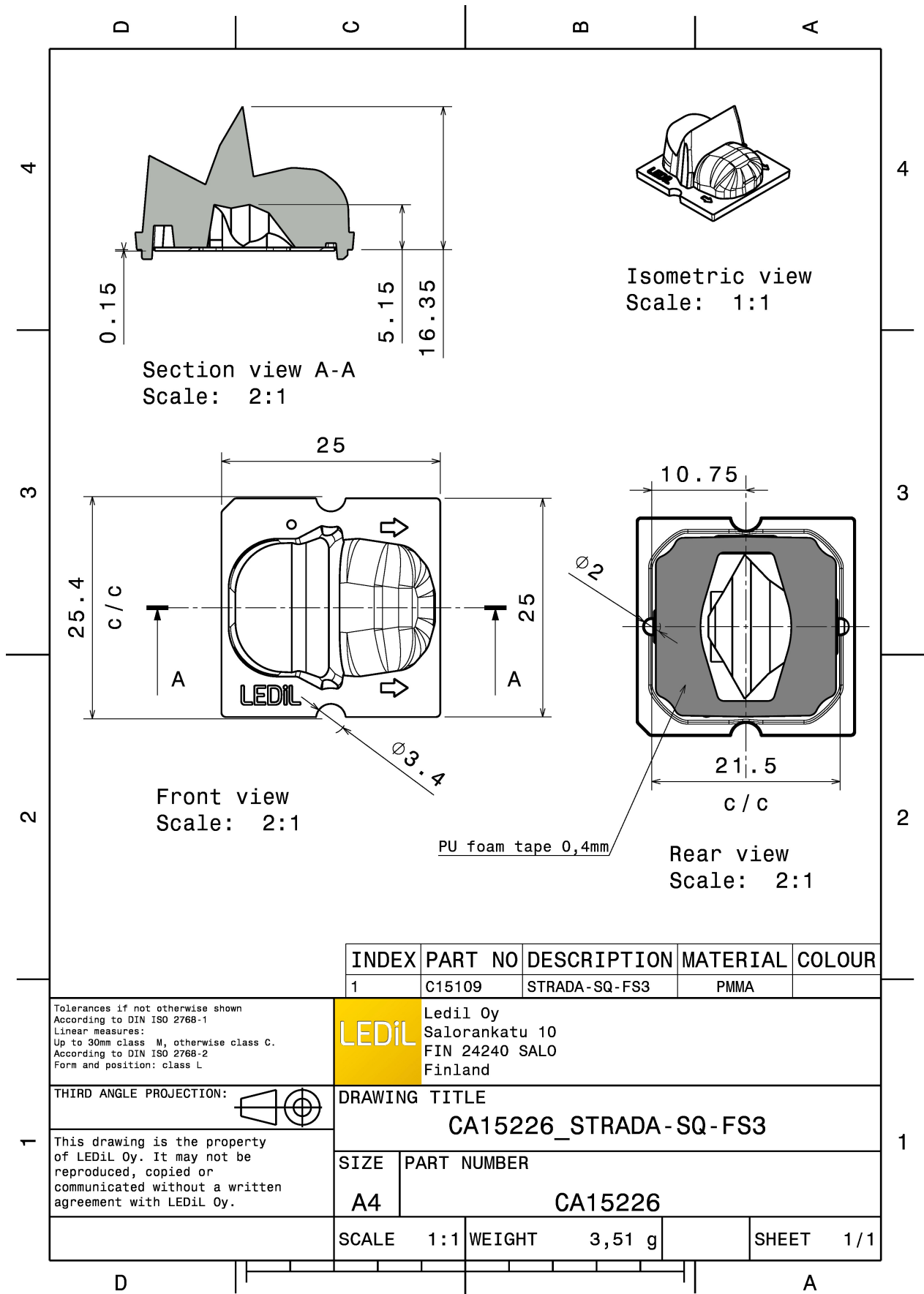

INDEX	PART NO	DESCRIPTION	MATERIAL	COLOUR
1	C15109	STRADA-SQ-FS3	PMMA	

Tolerances if not otherwise shown
According to DIN ISO 2768-1
Linear measures:
Up to 30mm class M, otherwise class C.
According to DIN ISO 2768-2
Form and position: class L



Ledil Oy
Salorankatu 10
FIN 24240 SALO
Finland

THIRD ANGLE PROJECTION:

DRAWING TITLE

CA15226_STRADA-SQ-FS3

This drawing is the property of LEDiL Oy. It may not be reproduced, copied or communicated without a written agreement with LEDiL Oy.

SIZE PART NUMBER

A4

CA15226

SCALE 1:1 WEIGHT 3,51 g SHEET 1/1

PHOTOMETRIC DATA (MEASURED):

CITIZEN

LED PSL440
 FWHM Asymmetric
 Efficiency 91 %
 Peak intensity 1.900 cd/lm
 Required components:

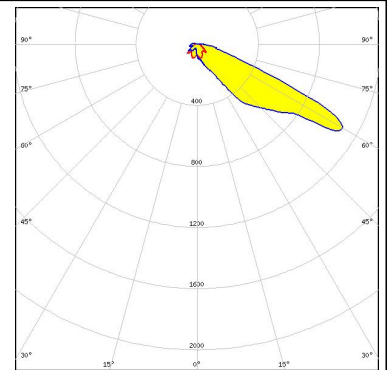

CITIZEN

LED PSL445
 FWHM Asymmetric
 Efficiency 91 %
 Peak intensity 1.000 cd/lm
 Required components:

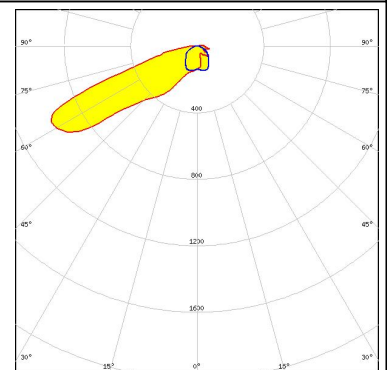

CREE

LED MK-R
 FWHM 125.0°
 Efficiency 88 %
 Peak intensity 1.298 cd/lm
 Required components:

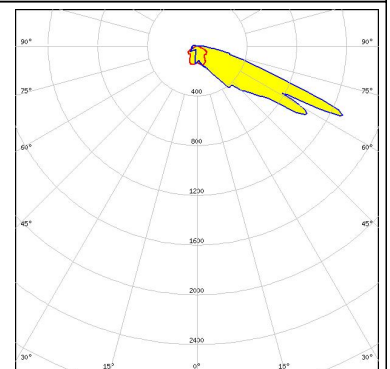
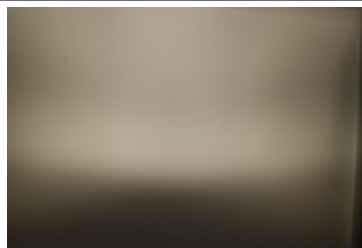

LUMILEDS

LED LUXEON M/MX
 FWHM Asymmetric
 Efficiency 90 %
 Peak intensity 1.200 cd/lm
 Required components:

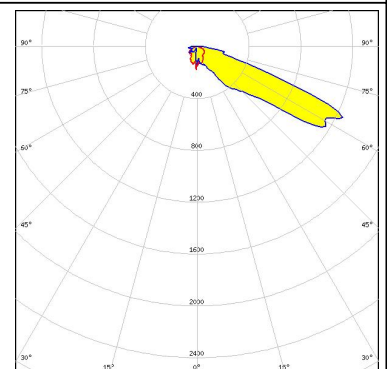

PHOTOMETRIC DATA (MEASURED):



LED NV4x144A
FWHM Asymmetric
Efficiency 78 %
Peak intensity 1.200 cd/lm
Required components:
Undefined Manufacturer: Protective Plate, Glass

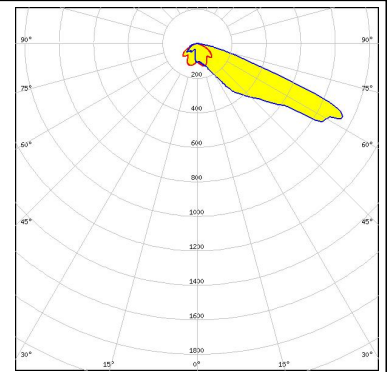

LED NV4x144A
FWHM Asymmetric
Efficiency 91 %
Peak intensity 1.300 cd/lm
Required components:

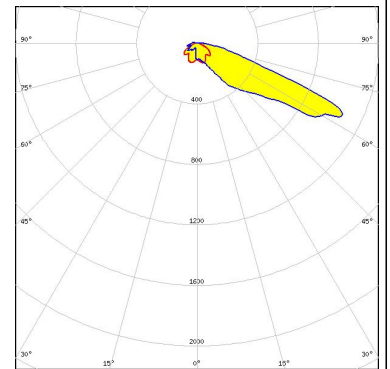

LED Duris S10
FWHM Asymmetric
Efficiency 86 %
Peak intensity 1.100 cd/lm
Required components:

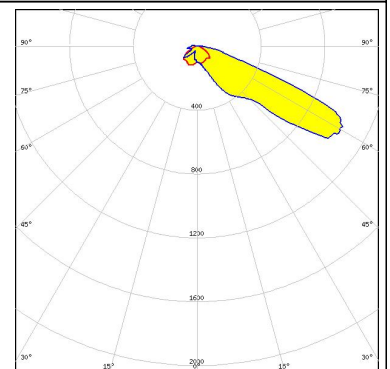

PHOTOMETRIC DATA (SIMULATED):



LED XHP50.2
FWHM Asymmetric
Efficiency 90 %
Peak intensity 1.210 cd/lm
Required components:

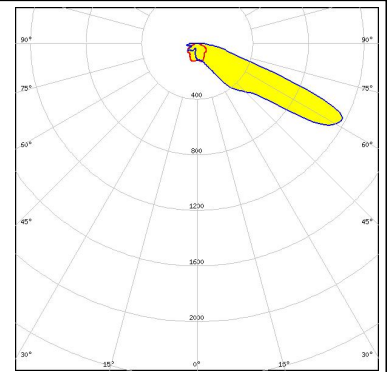

LED XHP50.2
FWHM Asymmetric
Efficiency 80 %
Peak intensity 1.060 cd/lm
Required components:
Undefined Manufacturer: Protective Plate, Glass

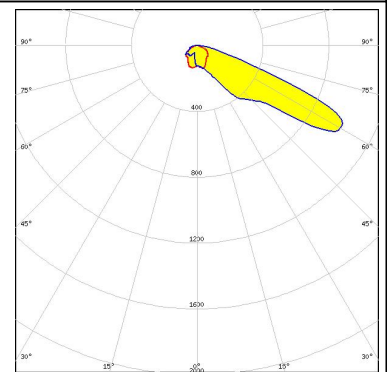

LED XHP70
FWHM Asymmetric
Efficiency 77 %
Peak intensity 0.910 cd/lm
Required components:
Undefined Manufacturer: Protective Plate, Glass

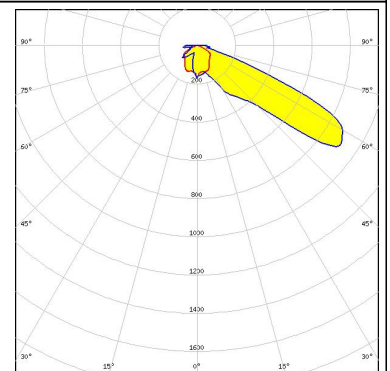

LED XM-L2
FWHM Asymmetric
Efficiency 88 %
Peak intensity 2.000 cd/lm
Required components:

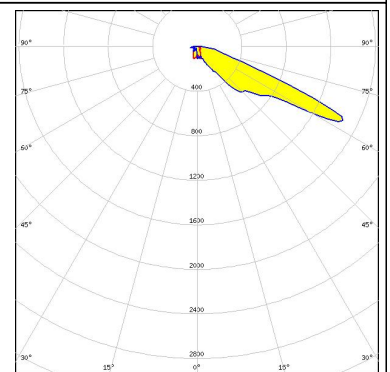

PHOTOMETRIC DATA (SIMULATED):



LED XP-G3
 FWHM Asymmetric
 Efficiency 90 %
 Peak intensity 1.730 cd/lm
 Required components:

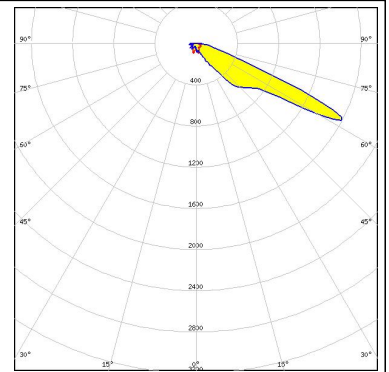

LED XT-E
 FWHM Asymmetric
 Efficiency 87 %
 Peak intensity 2.500 cd/lm
 Required components:

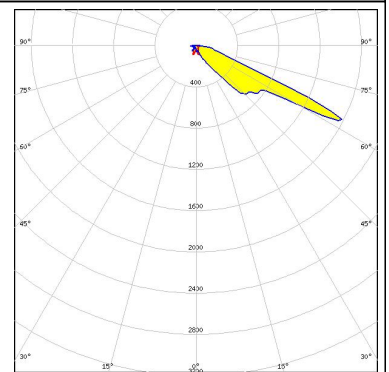

LED LUXEON M/MX
 FWHM Asymmetric
 Efficiency 73 %
 Peak intensity 1.100 cd/lm
 Required components:

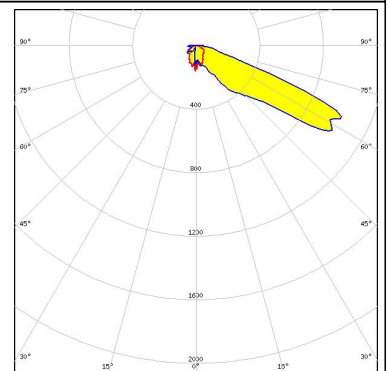

LED LUXEON M/MX
 FWHM Asymmetric
 Efficiency 76 %
 Peak intensity 1.000 cd/lm
 Required components:
 Undefined Manufacturer: Protective Plate, Glass

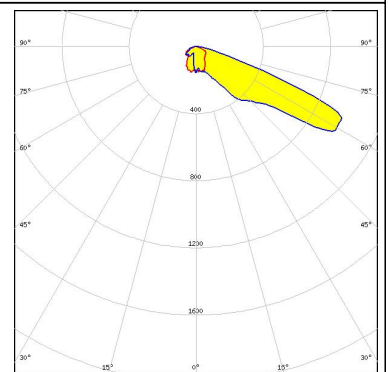

PHOTOMETRIC DATA (SIMULATED):



LED NVSxE21A
FWHM Asymmetric
Efficiency 89 %
Peak intensity 2.100 cd/lm
Required components:

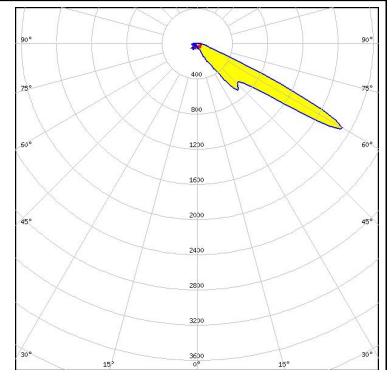

LED OSCONIQ P 7070
FWHM Asymmetric
Efficiency 85 %
Peak intensity 1.370 cd/lm
Required components:
Undefined Manufacturer: Protective Plate, Glass

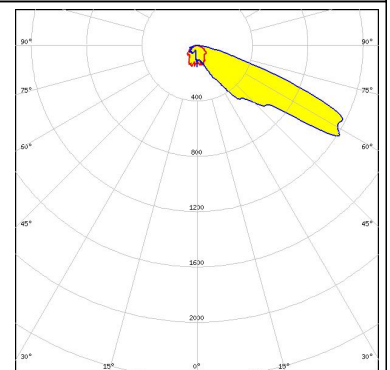

LED OSCONIQ P 7070
FWHM Asymmetric
Efficiency 94 %
Peak intensity 1.420 cd/lm
Required components:

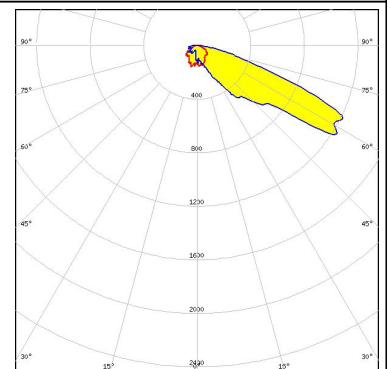

GENERAL INFORMATION:

NOTE: The typical beam angle will be changed by different color, chip size and chip position tolerance. The typical total beam angle is the full angle measured where the luminous intensity is half of the peak value.

MATERIALS:

As part of our continuous research and improvement processes, and to ensure the best possible quality and availability of our products, LEDiL reserves the right to change material grades without notice.

PRODUCT DATA USER AGREEMENT AND DISCLAIMER:

The measured data in the provided downloadable LEDiL Product Datasheets and Mechanical 2D-Drawings is rounded and provided as reference for planning. LEDiL Oy's optical specifications have been verified by conducting performance testing of the products in accordance with the company's quality system. The reported data are averaged results of multiple measurements with typical variation. LEDiL Oy reserves the right to without prior notification make changes and improvements to its products.

LEDiL Oy assumes neither warranty, nor guarantee nor any other liability of any kind for the contents and correctness of the provided data. The provided data has been generated with highest diligence but the provided data may in reality not represent the complete possible variation range of all intrinsic parameters. Therefore, in certain cases a deviation from the provided data could occur.

LEDiL Oy reserves the right to undertake technical changes of its products without further notification which could lead to changes in the provided data. LEDiL Oy assumes no liability of any kind for the possible deviation from any provided data or any other damage resulting from the usage of the provided data.

The user agrees to this disclaimer and user agreement with the download or usage of the provided files.

LEDiL Oy

Joensuunkatu 13
FI-24240 SALO
Finland

LEDiL Inc.

228 West Page Street
Suite D
Sycamore IL 60178
USA

Local sales and technical support

[www.ledil.com/
where_to_buy](http://www.ledil.com/where_to_buy)

Shipping locations

Salo, Finland
Hong Kong, China

Distribution Partners

[www.ledil.com/
where_to_buy](http://www.ledil.com/where_to_buy)