



Chipsmall Limited consists of a professional team with an average of over 10 year of expertise in the distribution of electronic components. Based in Hongkong, we have already established firm and mutual-benefit business relationships with customers from,Europe,America and south Asia,supplying obsolete and hard-to-find components to meet their specific needs.

With the principle of “Quality Parts,Customers Priority,Honest Operation,and Considerate Service”,our business mainly focus on the distribution of electronic components. Line cards we deal with include Microchip,ALPS,ROHM,Xilinx,Pulse,ON,Everlight and Freescale. Main products comprise IC,Modules,Potentiometer,IC Socket,Relay,Connector.Our parts cover such applications as commercial,industrial, and automotives areas.

We are looking forward to setting up business relationship with you and hope to provide you with the best service and solution. Let us make a better world for our industry!



## Contact us

Tel: +86-755-8981 8866 Fax: +86-755-8427 6832

Email & Skype: info@chipsmall.com Web: www.chipsmall.com

Address: A1208, Overseas Decoration Building, #122 Zhenhua RD., Futian, Shenzhen, China



**General Purpose High Current NPN Transistor Array**

The CA3083 is a versatile array of five high current (to 100mA) NPN transistors on a common monolithic substrate. In addition, two of these transistors (Q<sub>1</sub> and Q<sub>2</sub>) are matched at low current (i.e., 1mA) for applications in which offset parameters are of special importance.

Independent connections for each transistor plus a separate terminal for the substrate permit maximum flexibility in circuit design.

**Ordering Information**

PART NUMBER	PART MARKING	TEMP. RANGE (°C)	PACKAGE	PKG. DWG. #
CA3083	CA3083	-55 to 125	16 Ld PDIP	E16.3
CA3083Z (Note)	CA3083Z	-55 to 125	16 Ld PDIP* (Pb-free)	E16.3
CA3083M96	3083	-55 to 125	16 Ld SOIC Tape and Reel	M16.15
CA3083MZ (Note)	3083MZ	-55 to 125	16 Ld SOIC (Pb-Free)	M16.15
CA3083MZ96 (Note)	3083MZ	-55 to 125	16 Ld SOIC (Pb-Free) Tape and Reel	M16.15

\*Pb-free PDIPs can be used for through hole wave solder processing only. They are not intended for use in Reflow solder processing applications.

NOTE: Intersil Pb-free plus anneal products employ special Pb-free material sets; molding compounds/die attach materials and 100% matte tin plate termination finish, which are RoHS compliant and compatible with both SnPb and Pb-free soldering operations. Intersil Pb-free products are MSL classified at Pb-free peak reflow temperatures that meet or exceed the Pb-free requirements of IPC/JEDEC J STD-020.

**Features**

- High I<sub>C</sub> . . . . . 100mA (Max)
- Low V<sub>CE sat</sub> (at 50mA) . . . . . 0.7V (Max)
- Matched Pair (Q<sub>1</sub> and Q<sub>2</sub>)
  - V<sub>IO</sub> (V<sub>BE Match</sub>) . . . . . ±5mV (Max)
  - I<sub>IO</sub> (at 1mA) . . . . . 2.5µA (Max)
- 5 Independent Transistors Plus Separate Substrate Connection
- Pb-Free Plus Anneal Available (RoHS Compliant)

**Applications**

- Signal Processing and Switching Systems Operating from DC to VHF
- Lamp and Relay Driver
- Differential Amplifier
- Temperature Compensated Amplifier
- Thyristor Firing
- See Application Note AN5296 “Applications of the CA3018 Circuit Transistor Array” for Suggested Applications

**Pinout**

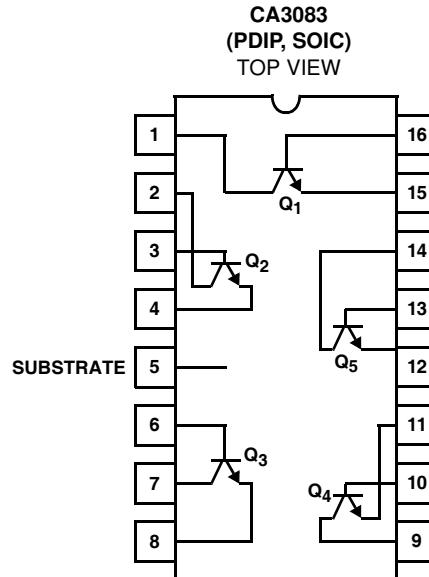

**Absolute Maximum Ratings**

The following ratings apply for each transistor in the device:  
 Collector-to-Emitter Voltage,  $V_{CEO}$  ..... 15V  
 Collector-to-Base Voltage,  $V_{CBO}$  ..... 20V  
 Collector-to-Substrate Voltage,  $V_{CIO}$  (Note 1) ..... 20V  
 Emitter-to-Base Voltage,  $V_{EBO}$  ..... 5V  
 Collector Current ( $I_C$ ) ..... 100mA  
 Base Current ( $I_B$ ) ..... 20mA

**Thermal Information**

Thermal Resistance (Typical, Note 2)  $\theta_{JA}$  (°C/W)  $\theta_{JC}$  (°C/W)  
 PDIP Package ..... 135 N/A  
 SOIC Package ..... 200 N/A  
 Maximum Power Dissipation (Any One Transistor) ..... 500mW  
 Maximum Junction Temperature (Plastic Package) ..... 150°C  
 Maximum Storage Temperature Range ..... -65°C to 150°C  
 Maximum Lead Temperature (Soldering 10s) ..... 300°C  
 (SOIC - Lead Tips Only)

**Operating Conditions**

Temperature Range ..... -55°C to 125°C

*CAUTION: Stresses above those listed in "Absolute Maximum Ratings" may cause permanent damage to the device. This is a stress only rating and operation of the device at these or any other conditions above those indicated in the operational sections of this specification is not implied.*

**NOTES:**

1. The collector of each transistor of the CA3083 is isolated from the substrate by an integral diode. The substrate must be connected to a voltage which is more negative than any collector voltage in order to maintain isolation between transistors and provide normal transistor action. To avoid undesired coupling between transistors, the substrate Terminal (5) should be maintained at either DC or signal (AC) ground. A suitable bypass capacitor can be used to establish a signal ground.
2.  $\theta_{JA}$  is measured with the component mounted on an evaluation PC board in free air.

**Electrical Specifications** For Equipment Design,  $T_A = 25^\circ\text{C}$

PARAMETER	SYMBOL	TEST CONDITIONS	MIN	TYP	MAX	UNITS	
<b>FOR EACH TRANSISTOR</b>							
Collector-to-Base Breakdown Voltage	$V_{(BR)CBO}$	$I_C = 100\mu\text{A}, I_E = 0$	20	60	-	V	
Collector-to-Emitter Breakdown Voltage	$V_{(BR)CEO}$	$I_C = 1\text{mA}, I_B = 0$	15	24	-	V	
Collector-to-Substrate Breakdown Voltage	$V_{(BR)CIO}$	$ I_C  = 100\mu\text{A}, I_B = 0, I_E = 0$	20	60	-	V	
Emitter-to-Base Breakdown Voltage	$V_{(BR)EBO}$	$I_E = 500\mu\text{A}, I_C = 0$	5	6.9	-	V	
Collector-Cutoff-Current	$I_{CEO}$	$V_{CE} = 10\text{V}, I_B = 0$	-	-	10	$\mu\text{A}$	
Collector-Cutoff-Current	$I_{CBO}$	$V_{CB} = 10\text{V}, I_E = 0$	-	-	1	$\mu\text{A}$	
DC Forward-Current Transfer Ratio (Note 3) (Figure 1)	$h_{FE}$	$V_{CE} = 3\text{V}$	$I_C = 10\text{mA}$	40	76	-	
			$I_C = 50\text{mA}$	40	75	-	
Base-to-Emitter Voltage (Figure 2)	$V_{BE}$	$V_{CE} = 3\text{V}, I_C = 10\text{mA}$	0.65	0.74	0.85	V	
Collector-to-Emitter Saturation Voltage (Figures 3, 4)	$V_{CE\text{ SAT}}$	$I_C = 50\text{mA}, I_B = 5\text{mA}$	-	0.40	0.70	V	
Gain Bandwidth Product	$f_T$	$V_{CE} = 3\text{V}, I_C = 10\text{mA}$	-	450	-	MHz	
<b>FOR TRANSISTORS Q<sub>1</sub> AND Q<sub>2</sub> (As a Differential Amplifier)</b>							
Absolute Input Offset Voltage (Figure 6)	$ V_{IO} $	$V_{CE} = 3\text{V}, I_C = 1\text{mA}$	-	1.2	5	mV	
Absolute Input Offset Current (Figure 7)	$ I_{IO} $	$V_{CE} = 3\text{V}, I_C = 1\text{mA}$	-	0.7	2.5	$\mu\text{A}$	

**NOTE:**

3. Actual forcing current is via the emitter for this test.



Typical Performance Curves

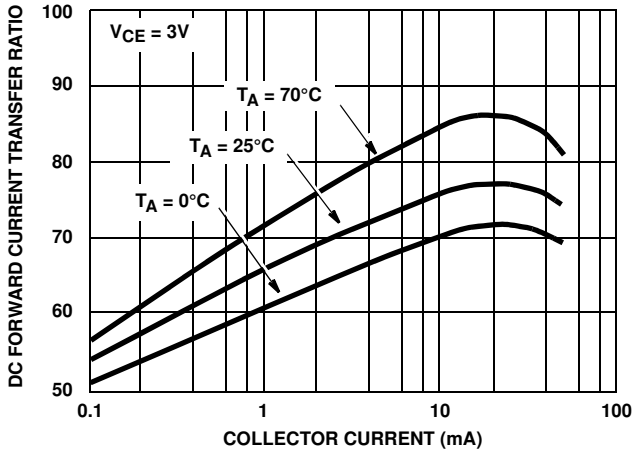

FIGURE 1.  $h_{FE}$  vs  $I_C$

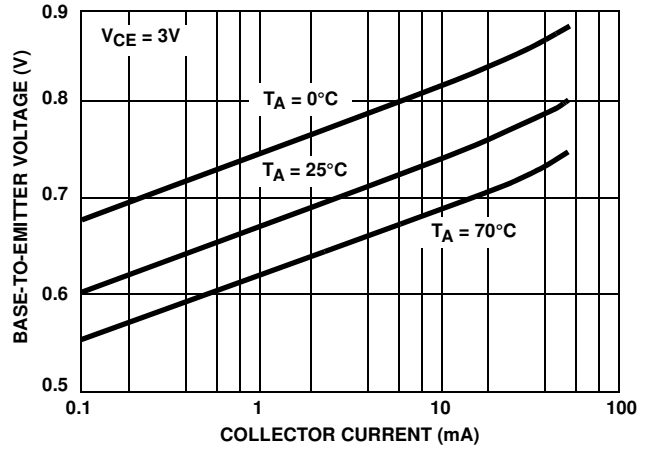

FIGURE 2.  $V_{BE}$  vs  $I_C$

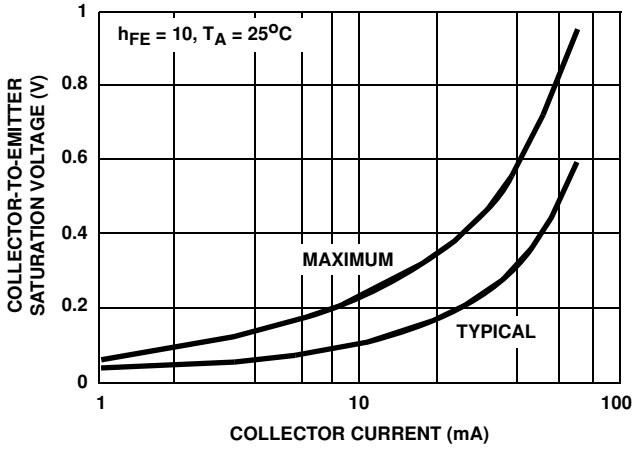

FIGURE 3.  $V_{CE SAT}$  vs  $I_C$

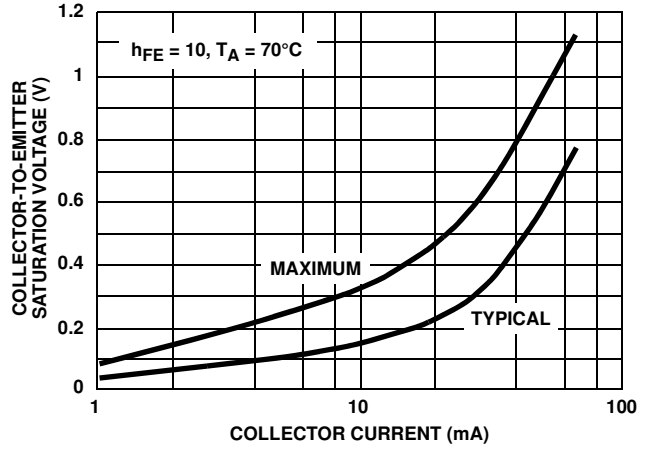

FIGURE 4.  $V_{CE SAT}$  vs  $I_C$

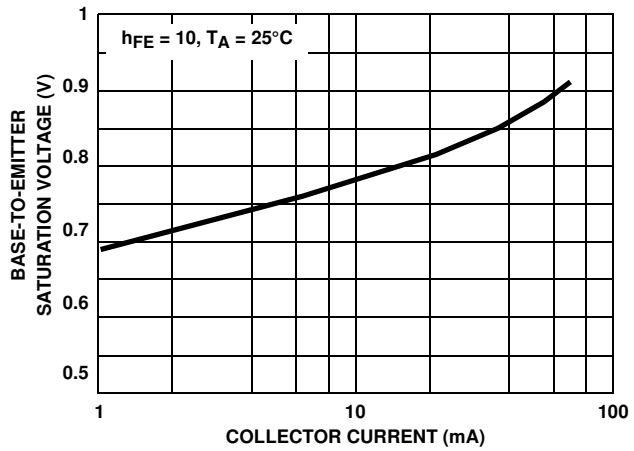

FIGURE 5.  $V_{BE SAT}$  vs  $I_C$

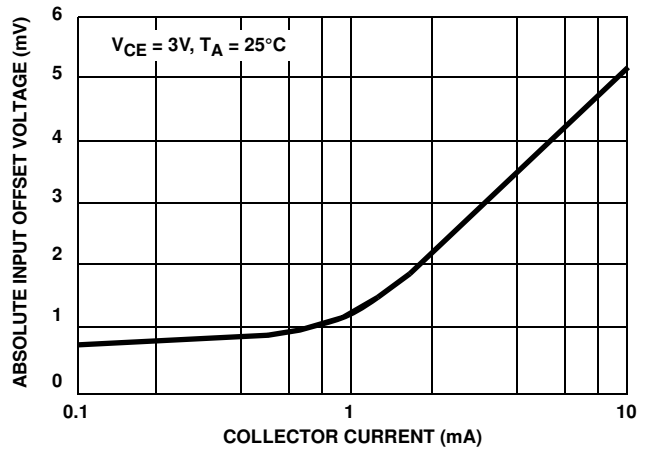

FIGURE 6.  $V_{IO}$  vs  $I_C$  (TRANSISTORS  $Q_1$  AND  $Q_2$  AS A DIFFERENTIAL AMPLIFIER)

Typical Performance Curves (Continued)

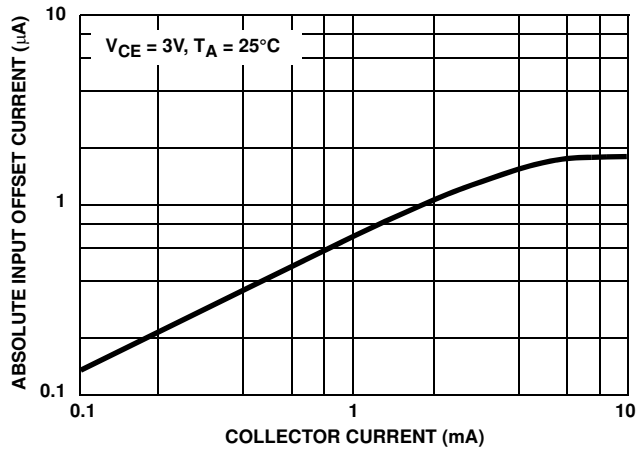

FIGURE 7.  $I_{IO}$  vs  $I_C$  (TRANSISTORS  $Q_1$  AND  $Q_2$  AS A DIFFERENTIAL AMPLIFIER)

All Intersil U.S. products are manufactured, assembled and tested utilizing ISO9000 quality systems.  
 Intersil Corporation's quality certifications can be viewed at [www.intersil.com/design/quality](http://www.intersil.com/design/quality)

*Intersil products are sold by description only. Intersil Corporation reserves the right to make changes in circuit design, software and/or specifications at any time without notice. Accordingly, the reader is cautioned to verify that data sheets are current before placing orders. Information furnished by Intersil is believed to be accurate and reliable. However, no responsibility is assumed by Intersil or its subsidiaries for its use; nor for any infringements of patents or other rights of third parties which may result from its use. No license is granted by implication or otherwise under any patent or patent rights of Intersil or its subsidiaries.*

For information regarding Intersil Corporation and its products, see [www.intersil.com](http://www.intersil.com)