



Chipsmall Limited consists of a professional team with an average of over 10 year of expertise in the distribution of electronic components. Based in Hongkong, we have already established firm and mutual-benefit business relationships with customers from,Europe,America and south Asia,supplying obsolete and hard-to-find components to meet their specific needs.

With the principle of “Quality Parts,Customers Priority,Honest Operation,and Considerate Service”,our business mainly focus on the distribution of electronic components. Line cards we deal with include Microchip,ALPS,ROHM,Xilinx,Pulse,ON,Everlight and Freescale. Main products comprise IC,Modules,Potentiometer,IC Socket,Relay,Connector.Our parts cover such applications as commercial,industrial, and automotives areas.

We are looking forward to setting up business relationship with you and hope to provide you with the best service and solution. Let us make a better world for our industry!



Contact us

Tel: +86-755-8981 8866 Fax: +86-755-8427 6832

Email & Skype: info@chipsmall.com Web: www.chipsmall.com

Address: A1208, Overseas Decoration Building, #122 Zhenhua RD., Futian, Shenzhen, China



Proximity Sensors Capacitive Thermoplastic Polyester Types CA30CLN12Mxxxx

CARLO GAVAZZI

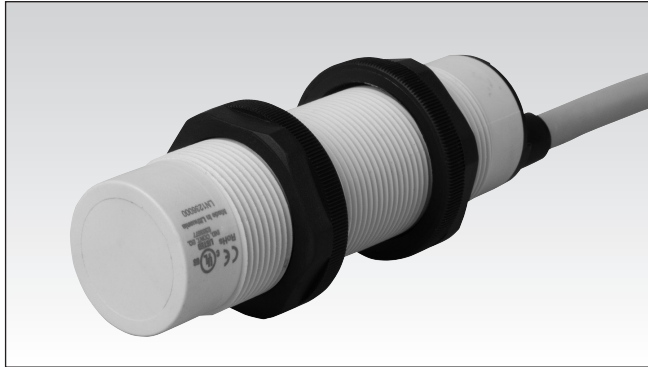

- Level sensor for solid, fluid or granulated substances
- Adjustable sensing distance: 4-12 mm
- Multi voltage supply: 20.4 to 255 VAC/DC
- SPDT relay output
- Time delay on operate or release
- Time delay options up to 10 minutes
- CA30..MU/CA30..MV: With adjustable time delay
- CA30CLN12MT: Without time delay
- Cable versions

Product Description

Capacitive sensor in M30 thermoplastic polyester housing for mounting with 2 nuts. Available with adjustable sensing distance and with/without built-in time

delay (ON or OFF delay). The relay output ensures that the load can be driven directly. Excellent for use in the agricultural sector (detection of grains, fluids etc.).

Ordering Key CA30CLN12MU10M

Type _____
 Time delay options _____
 Voltage _____
 Time delay _____

Type Selection

| Supply voltage | Ordering no. With ON delay | Ordering no. With OFF delay | Ordering no. Without time delay |
|-----------------|-------------------------------|--------------------------------|------------------------------------|
| 24- 230 V AC/DC | CA30CLN12MU10M | CA30CLN12MV10M | CA30CLN12MT |

Specifications

| | | | | |
|----------------------------------------------------|------------------------------------------------------------------------------|---------------------------------------|-------------------------------------------------------------------------------------------------------------------------------|-----------------------------------------------------------------------------------------------------------------------------------------------|
| Rated operating distance (S_n) | Up to 12 mm, reference target 30 x 30 mm ST37.1 mm thick, grounded | Response time | OFF-ON (t _{ON}) ON-OFF (t _{OFF}) | ≤ 500 ms ≤ 500 ms |
| Sensing distance | 4-12 mm, adjustable Factory set at 7 mm | Power ON delay (t_v) | | ≤ 200 ms |
| Sensing distance adjustment | Multiturn, 15 turns adjustment steps | Output function | | SPDT relay |
| Temperature drift | 0.8 x S _r ≤ S _u ≤ 1.2 x S _r | Output switching function | | N.O. and N.C. |
| Hysteresis (H) | 3 to 20% | Indication | Output ON Time Delay | Yellow LED LED flashing depend on time delay |
| Rated operational volt. (U_B) | 20.4 to 255 VAC/DC (ripple included) | Output Time delay | Delay on operate, adjustment CA30CLN12MU10M Delay on release, adjustment CA30CLN12MV10M No time delay CA30CLN12MT | Factory settings 0 sec. 1 sec. - 10 min. 1 sec. - 10 min. no delay |
| Rated supply frequency | 47 to 63 Hz | Time delay adjustment | | Multiturn, 15 turns |
| Rated operational power | 0.5 to 2.5 VA | Environment | Installation category Pollution degree Degree of protection | III (IEC 60664/60664A; 60947-1) 3 (IEC 60664/60664A; 60947-1) IP 67, (IEC 60529; 60947-1) NEMA 1, 2, 4, 4X, 5, 6, 6P, 12 |
| Output | 2 A Relay SPDT@240 VAC AC12 2 A AC140 2 A DC12 2 A DC13 2 A | | | |
| Mechanical life typically Electrical lifetime | 15x10 ⁶ operations 1x10 ⁵ operations @ 2A/240VAC | | | |
| Minimum operational current (I_m) | 10 mA@12 VDC (i.e. Minimum relay current) | | | |
| Protection | Reverse polarity and transients | | | |
| Operating frequency (f) | ≤ 1 Hz | | | |

Specifications (cont.)

| | | | |
|-----------------------------------------------------|----------------------------------------------------------------------|--------------------------------------------------------|---------------------------------------------------------|
| Ambient temperature Operating temperature | -20° to +70°C (-4° to +158°F) | Housing material Body Backpart Trimmer | PBTP Arnite LCP Vectra |
| Storage temperature | -40° to +85°C (-40° to +185°F) | Connection Cable | PVC, grey, 2 m 5 x 0.75 mm ² , Ø = 7.5 mm |
| Vibration | 10 to 150 Hz, 1.0 mm/15 G (IEC 60068-2-6) | Weight | ≤ 320 g |
| Shock | 30 g / 11ms, 3 pos, 3 neg per axis (IEC 60068-2-6, 60068-2-32) | Approvals UL (overvoltage category II) | cULus (UL508+CSA) |
| Rated insulation voltage | ≥ 250 VAC (rms) | CE-marking | Yes |

Dimensions

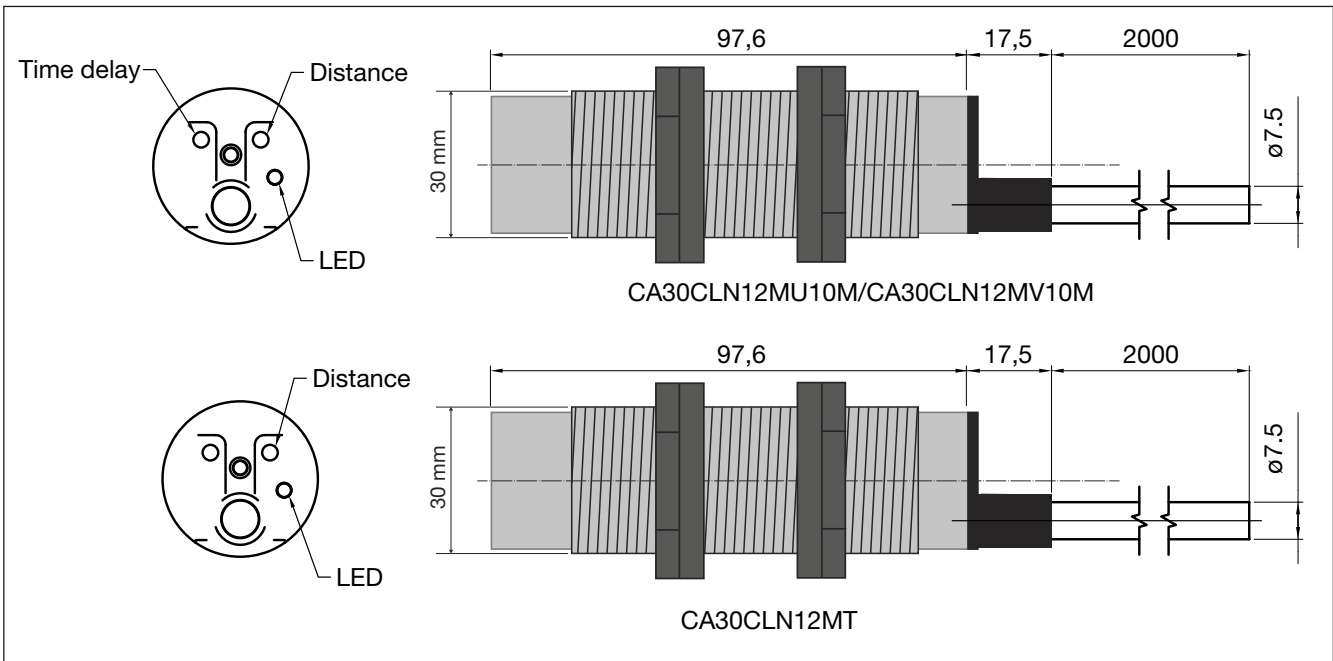

Trimmer VS Delaytime

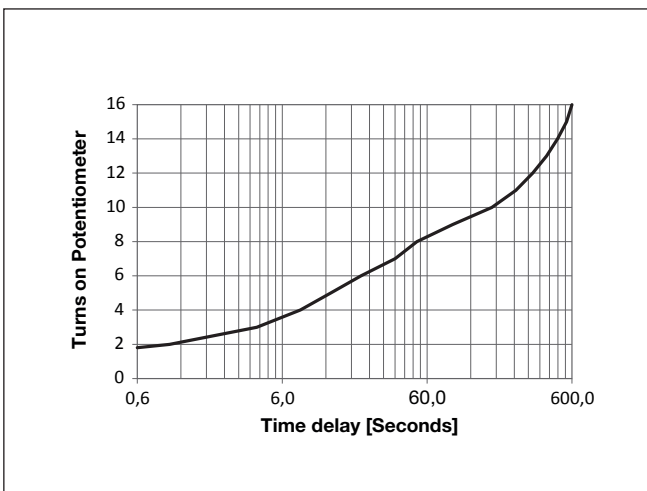

Trimmer VS Distance

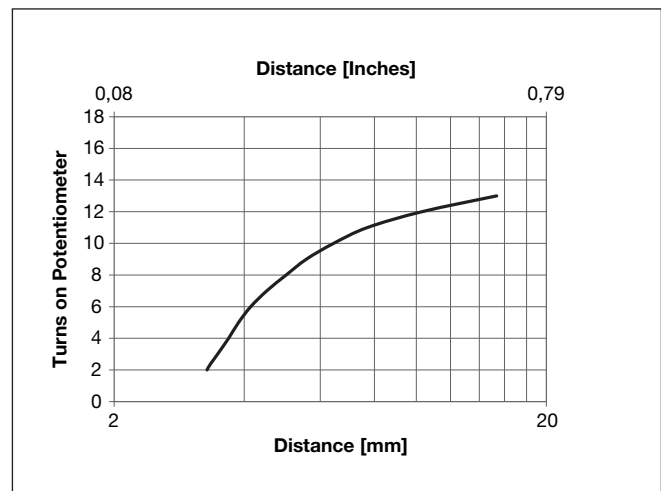

Detection Diagram

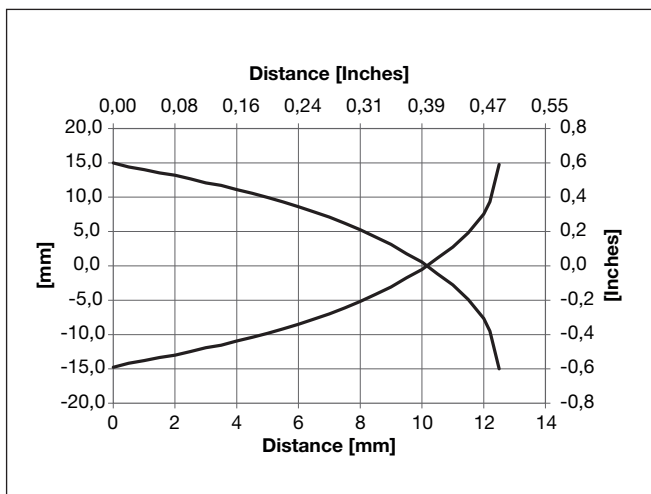

Wiring Diagram

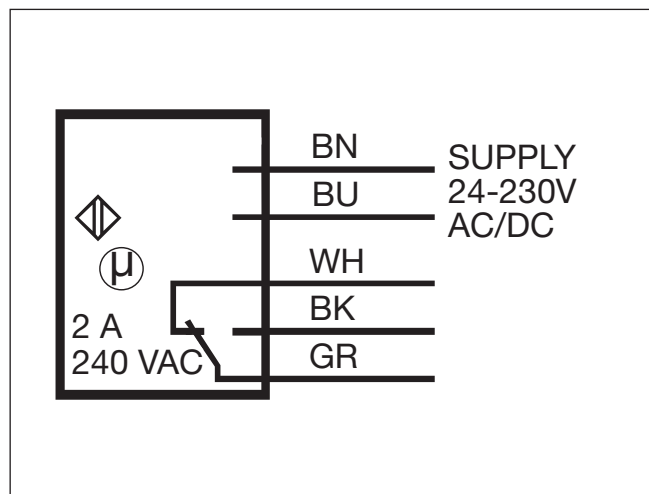

Mode of Operation

CA30CLN12MU10M (See operation diagram). Power supply is applied to the sensor (BN and BU wires). When the target is not present, the relay operates (connection between GR and BK wires) and LED lights. When the target is detect-

ed the time measurement starts and LED flashes. After expiration of the set time (0-10 min.), the relay releases (connection between GR and WH wires) and LED turns off. The relay remains released as long as the target is detected.

CA30CLN12MV10M (See operation diagram). Power supply is applied to the sensor BN and BU wires) and time measurement starts. When the set time has expired (0-10 min.) the relay operates (connection between GR and BK wires)

and remains connected until the target is detected. After activation of the sensor the relay releases (connection between GR and WH wires). As soon as the target is not present again the time measurements of the set time starts.

CA30CLN12MT (See operation diagram). Power supply is applied to the sensor (BN and BU wires). The relay operates (connection between GR and BK wires)

and remains ON until the target is detected. After activation of the sensor the relay releases (connection between GR and WH wires.)

Adjustment

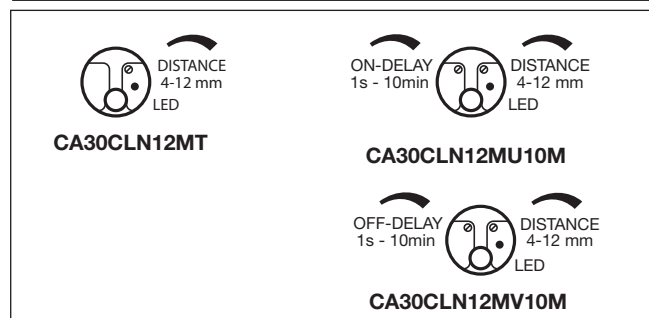

Operation Diagrams

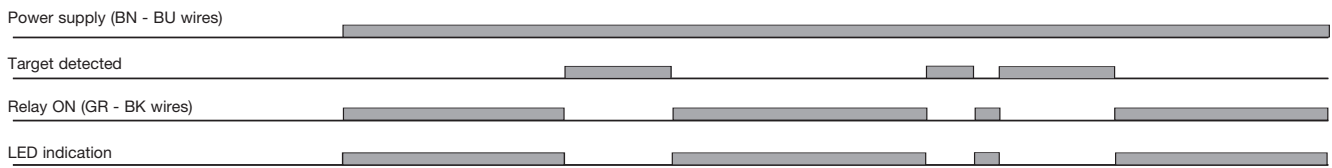

CA30CLN12MT

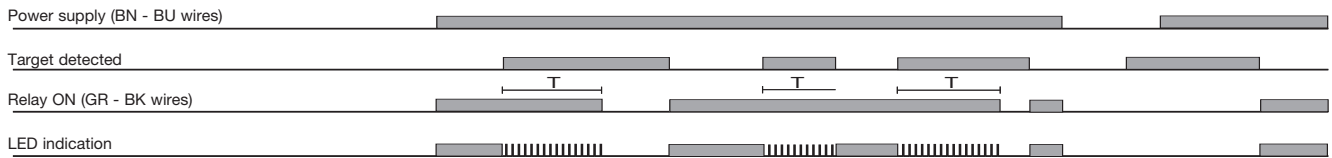

CA30CLN12MU10M

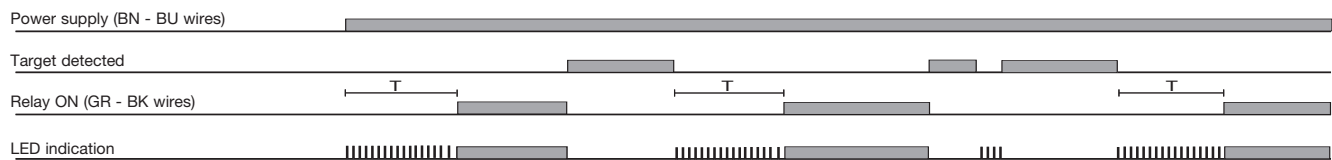

CA30CLN12MV10M

Installation Hint

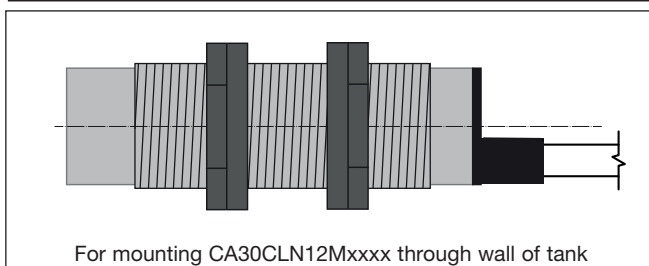

Delivery Contents

- Capacitive switch: CA30CLN12Mxxxx
- Installation instruction
- 2 x M30 Nuts
- Screwdriver
- Packaging: Plastic bag