



Chipsmall Limited consists of a professional team with an average of over 10 year of expertise in the distribution of electronic components. Based in Hongkong, we have already established firm and mutual-benefit business relationships with customers from,Europe,America and south Asia,supplying obsolete and hard-to-find components to meet their specific needs.

With the principle of “Quality Parts,Customers Priority,Honest Operation,and Considerate Service”,our business mainly focus on the distribution of electronic components. Line cards we deal with include Microchip,ALPS,ROHM,Xilinx,Pulse,ON,Everlight and Freescale. Main products comprise IC,Modules,Potentiometer,IC Socket,Relay,Connector.Our parts cover such applications as commercial,industrial, and automotives areas.

We are looking forward to setting up business relationship with you and hope to provide you with the best service and solution. Let us make a better world for our industry!



Contact us

Tel: +86-755-8981 8866 Fax: +86-755-8427 6832

Email & Skype: info@chipsmall.com Web: www.chipsmall.com

Address: A1208, Overseas Decoration Building, #122 Zhenhua RD., Futian, Shenzhen, China



SPECIFICATION

Part No. : **CAB.R02**

Product Name : Taoglas Cable Assembly
Murata HSC to SMA(F)Bulkhead Straight Connector
with 200mm \varnothing 0.81 cable

Photo :



1. Cable Insertion Loss

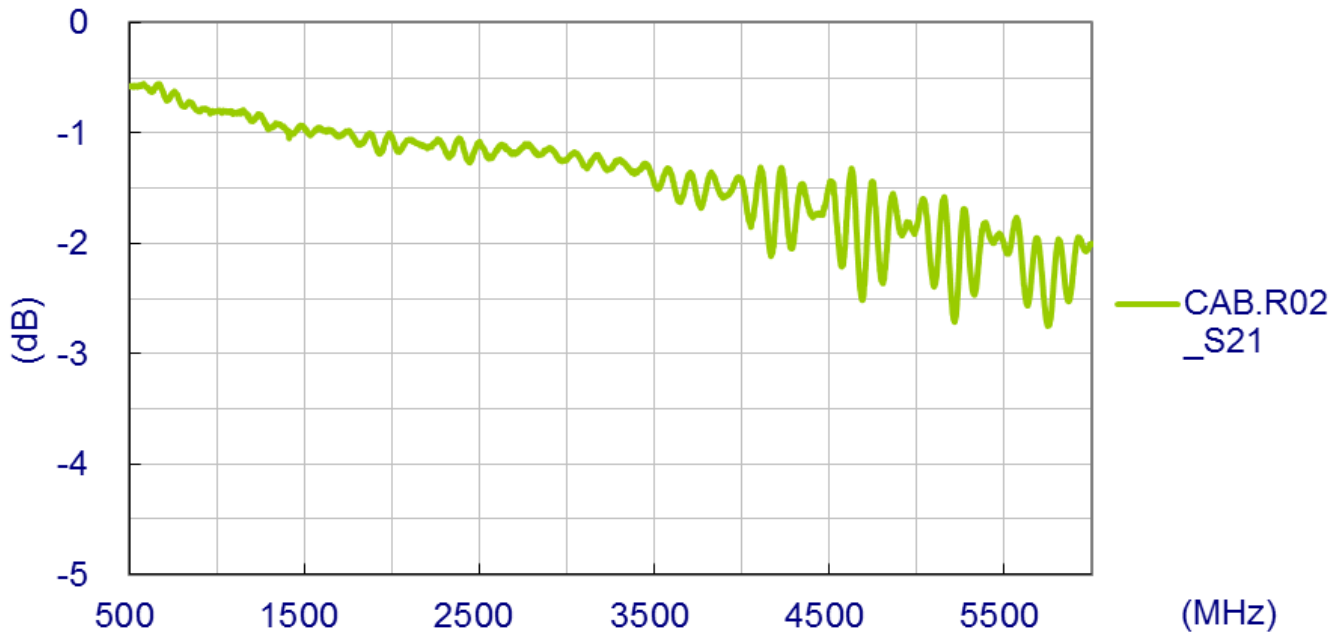

2. 0.81 Cable Specification

2.1 Drawing – Cross Section

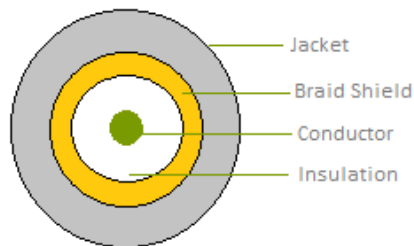

2.2 Structure and Dimensions

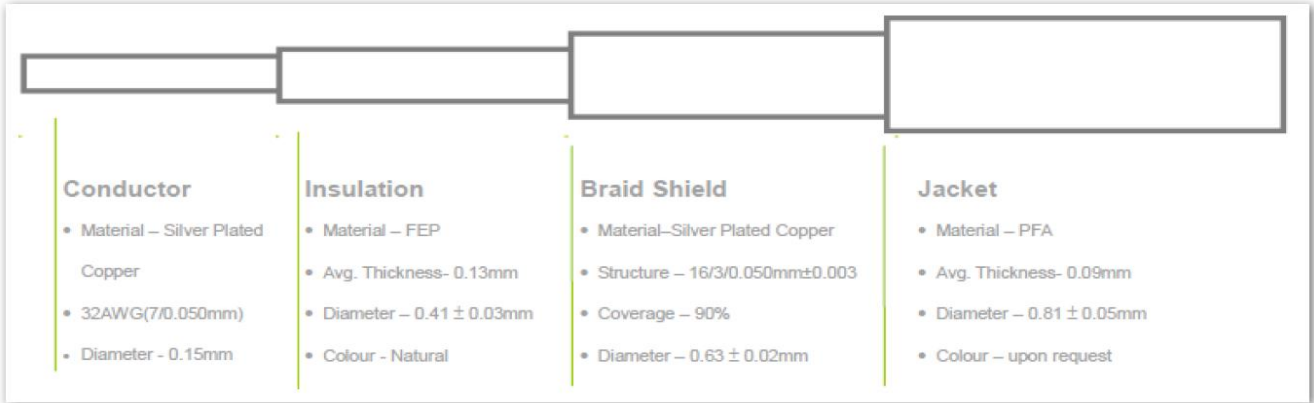

2.3 Electrical & Physical Specification

1	Insulation Resistance:	1000 MEGA OHM-KM Min.	
2	Conductor Resistance:	1400 OHM/KM/20°C Max.	
3	Dielectric Strength:	AC 1.0 KV/minute	
4	Spark test:	2.5 KV	
5	Nom. Impedance	50 ± 3 Ohms	
6	Nom. Capacitance	97 ± 3 pF/m	
7	Attenuation (dB/1M)	2.0GHz	3.60
		2.4GHz	5.10
		3.0GHz	6.20
		4.0GHz	7.50
		5.0GHz	8.50
		6.0GHz	9.40

3. Technical Drawing

3.1 CAB.R02

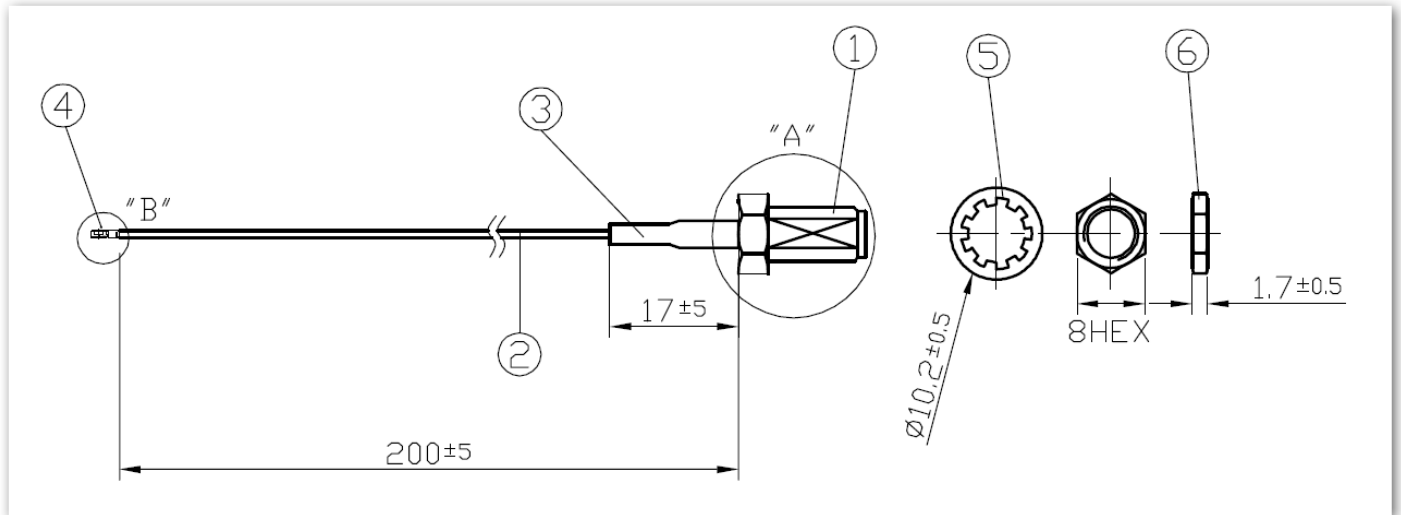

	Name	Part No.	Material	Finish	QTY
1	SMA(F) ST	SMA.F.ST.JACK.B.W	Brass	Gold	1
2	0.81 Cable	OD.081.W	FEP	Gray	1
3	Heat Shrink Tube	001312E000014A	PE	Black	1
4	Murata HSC	MUR.HSC.081	Brass	Ni Plated	1
5	Washer	See Connector Spec	Brass	Gold	1
6	Nut	See Connector Spec	Brass	Gold	1

3.2 Connectors

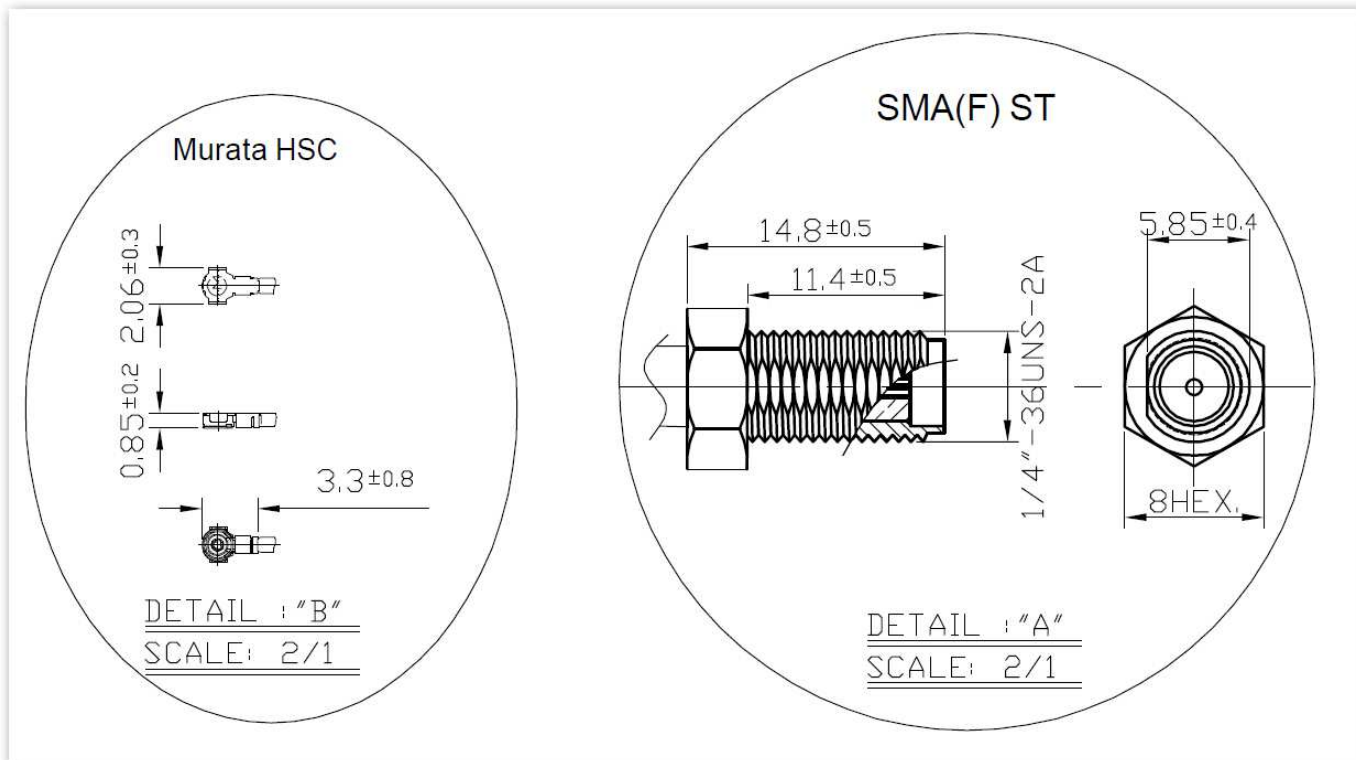

3.3 Recommended Mounting Hole – SMA(F) Bulkhead

