



Chipsmall Limited consists of a professional team with an average of over 10 year of expertise in the distribution of electronic components. Based in Hongkong, we have already established firm and mutual-benefit business relationships with customers from,Europe,America and south Asia,supplying obsolete and hard-to-find components to meet their specific needs.

With the principle of “Quality Parts,Customers Priority,Honest Operation,and Considerate Service”,our business mainly focus on the distribution of electronic components. Line cards we deal with include Microchip,ALPS,ROHM,Xilinx,Pulse,ON,Everlight and Freescale. Main products comprise IC,Modules,Potentiometer,IC Socket,Relay,Connector.Our parts cover such applications as commercial,industrial, and automotives areas.

We are looking forward to setting up business relationship with you and hope to provide you with the best service and solution. Let us make a better world for our industry!



## Contact us

Tel: +86-755-8981 8866 Fax: +86-755-8427 6832

Email & Skype: info@chipsmall.com Web: www.chipsmall.com

Address: A1208, Overseas Decoration Building, #122 Zhenhua RD., Futian, Shenzhen, China



## SPECIFICATION

Part No. : **CAB.W08**

Product Name : Taoglas Cable Assembly  
NMO Magnet Mount - 3/4 inch Style Brass Mount type to  
SMA(M) Straight Plug  
with 3ft(915mm) RG-58 cable

Photo :



# 1. Cable Insertion Loss

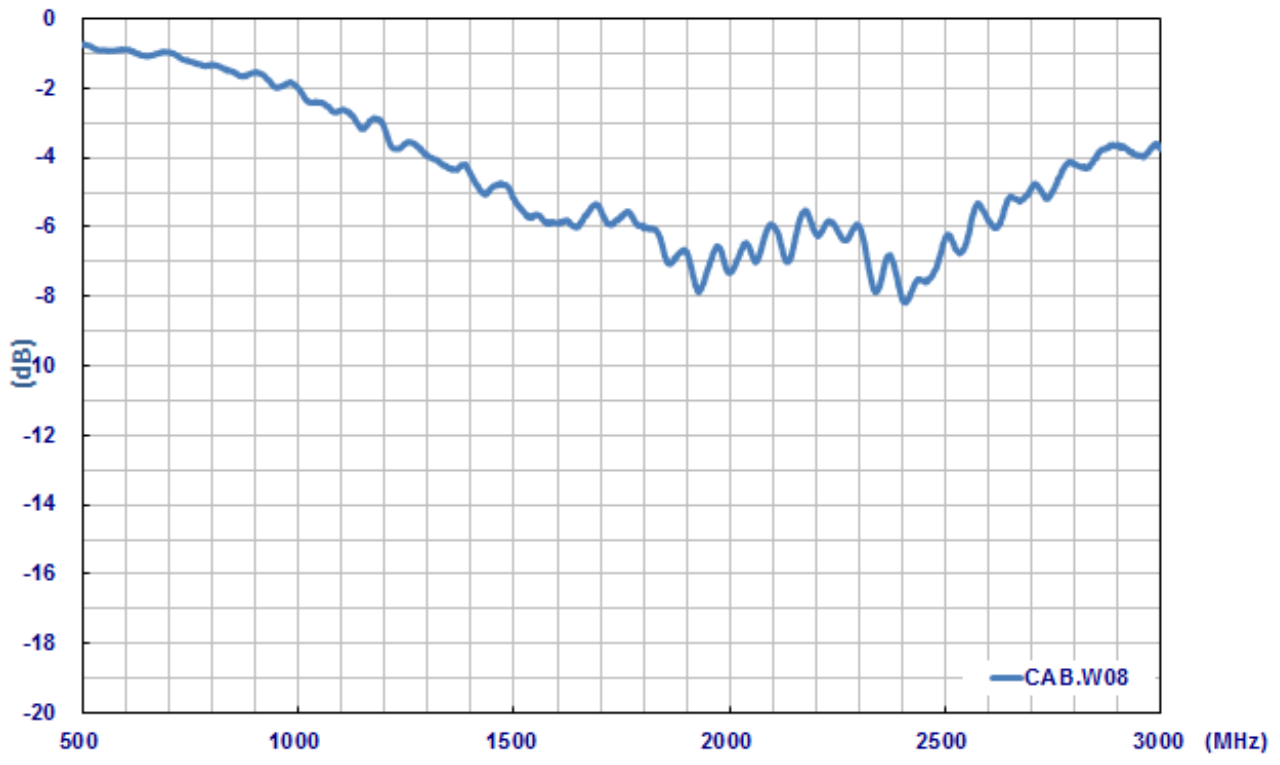

## 2. RG-58 Cable Specification

### 2.1 Drawing – Cross Section

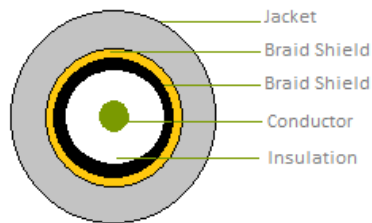

### 2.2 Structure and Dimensions

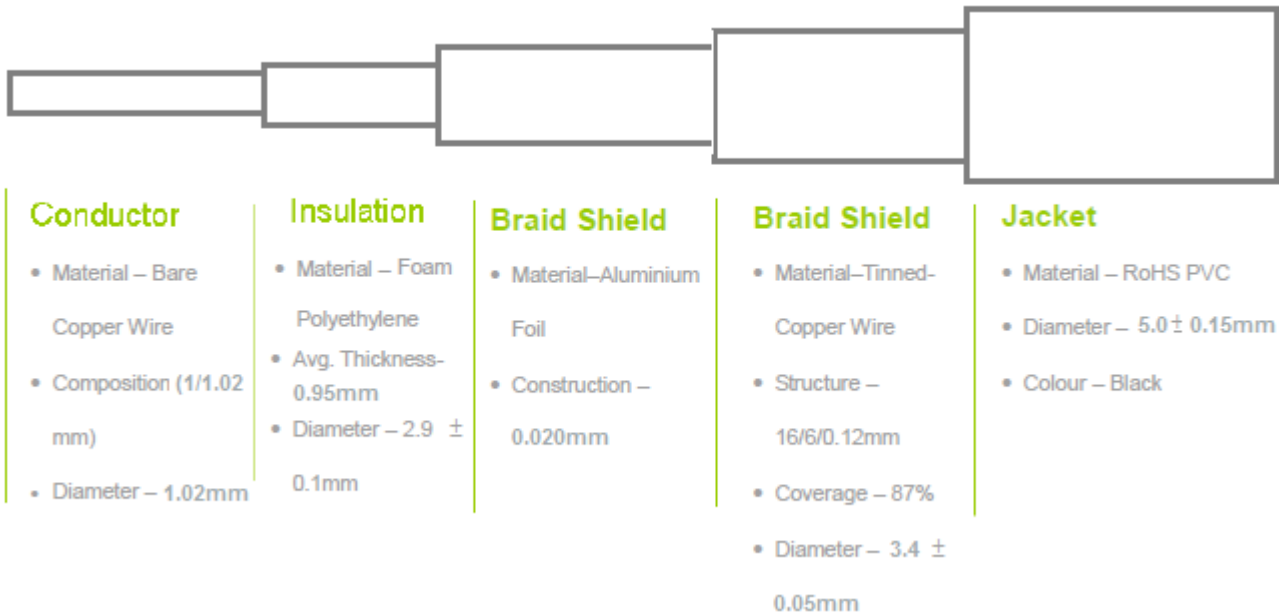

### 2.3 Electrical & Physical Specification

Insulation Resistance:	1000 MΩ-Km (Min)				
Capacitance	83 ± 3 pF/m				
Nom. Impedance	53 ± 3 Ω				
Attenuation (dB/100ft)	200MHz	400MHz	700MHz	900MHz	1000MHz
	4.66	6.32	8.45	9.67	10.2

### 3. Technical Drawing

#### 3.1 CAB.W08

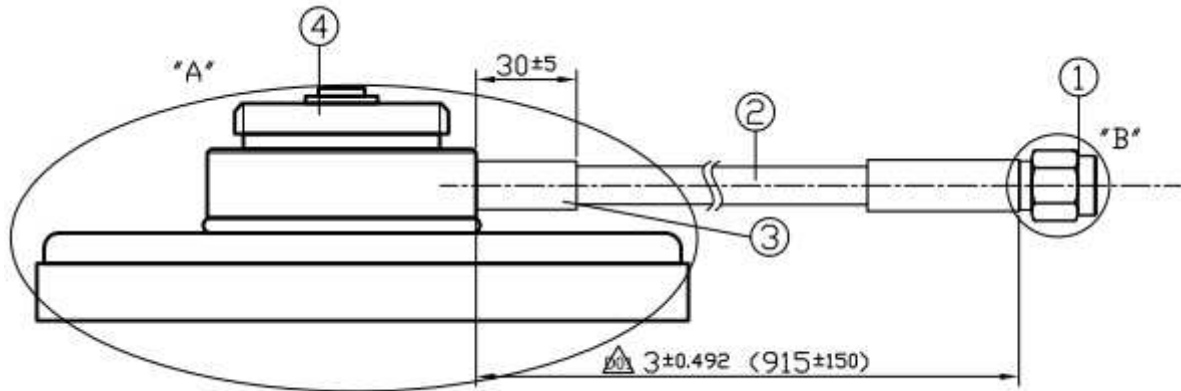

	Name	Material	Finish	QTY
1	SMA(M) ST	Brass	Ni Plated	1
2	RG58 Coaxial Cable	PVC	Black	1
3	Heat Shrink Tube	PE	Black	1
4	NMO(MM)	Brass	Ni Plated	1

### 3.2 Connectors

