



Chipsmall Limited consists of a professional team with an average of over 10 year of expertise in the distribution of electronic components. Based in Hongkong, we have already established firm and mutual-benefit business relationships with customers from,Europe,America and south Asia,supplying obsolete and hard-to-find components to meet their specific needs.

With the principle of “Quality Parts,Customers Priority,Honest Operation,and Considerate Service”,our business mainly focus on the distribution of electronic components. Line cards we deal with include Microchip,ALPS,ROHM,Xilinx,Pulse,ON,Everlight and Freescale. Main products comprise IC,Modules,Potentiometer,IC Socket,Relay,Connector.Our parts cover such applications as commercial,industrial, and automotives areas.

We are looking forward to setting up business relationship with you and hope to provide you with the best service and solution. Let us make a better world for our industry!



Contact us

Tel: +86-755-8981 8866 Fax: +86-755-8427 6832

Email & Skype: info@chipsmall.com Web: www.chipsmall.com

Address: A1208, Overseas Decoration Building, #122 Zhenhua RD., Futian, Shenzhen, China



CAR2012TE series rectifier

Input: 85Vac to 264Vac; Output: 12Vdc @ 2000W; 3.3 @ 4A or 5Vdc @ 3A Standby

RoHS Compliant



Features

- Efficiency: greater than 94.5 % @ 50% load. Except at 50% load, exceeding 80plus "Titanium" criteria
- Universal input with PFC
- Constant power characteristic
- 2 front panel LEDs: 1-input;2-[DC_OK, fault, warning]
- Remote ON/OFF control of the 12Vdc output
- Remote sense on the 12Vdc output
- No minimum load requirements
- Active load sharing (single wire)
- Hot Plug-ability
- Standby orderable either as 3.3Vdc @ 4A or 5Vdc @ 3A
- Auto recoverable OC & OT protection
- Operating temperature: -10 - 70°C (de-rated above 50°C)
- Digital status & control: PMBus serial bus
- EN/IEC/UL/CSA C22.2 60950-1 2nd edition +A1, CCC
- CE mark§
- Meets FCC part 15, EN55022 Class A standards
- Meets EN61000 immunity and transient standards
- Shock & vibration: Meets IPC 9592 Class II standards

Applications

- 12Vdc distributed power architectures
- Datacom and Telecom applications
- Mid to high-end Servers
- Routers/Switches
- Broadband Switches
- ATE Equipment

Description

The CAR2012TE Front-End provides highly efficient isolated power from worldwide input mains in a compact 1U industry standard form factor. This power supply is ideal for applications where mid to light load efficiency is of key importance in order to reduce system power consumption during 'typical' operational conditions.

The high-density, front-to-back airflow is designed for minimal space utilization and is highly expandable for future growth. The industry standard PMBus compliant I²C communications bus offers a full range of control and monitoring capabilities. The SMBAlert signal pin automatically alerts customers of any state change within the power supply.

* UL is a registered trademark of Underwriters Laboratories, Inc.

† CSA is a registered trademark of Canadian Standards Association.

‡ VDE is a trademark of Verband Deutscher Elektrotechniker e.V.

§ Intended for integration into end-user equipment. All the required procedures for CE marking of end-user equipment should be followed. (The CE mark is placed on selected products.)

** ISO is a registered trademark of the International Organization of Standards.

+ PMBus name and logo are registered trademarks of the System Management Interface Forum (SMIF)

CAR2012TE series rectifier

Input: 85Vac to 264Vac; Output: 12 Vdc @ 2000W; 3.3Vdc or 5 Vdc @ 4A

Absolute Maximum Ratings

Stresses in excess of the absolute maximum ratings can cause permanent damage to the device. These are absolute stress ratings only, functional operation of the device is not implied at these or any other conditions in excess of those given in the operations sections of the data sheet. Exposure to absolute maximum ratings for extended periods can adversely affect the device reliability.

Parameter	Symbol	Min	Max	Unit
Input Voltage: Continuous	V _{IN}	0	264	V _{AC}
Operating Ambient Temperature	T _A	-10	70	°C
Storage Temperature	T _{stg}	-40	85	°C
I/O Isolation voltage to Frame (100% factory Hi-Pot tested)			2121	V _{DC}

Electrical Specifications

Unless otherwise indicated, specifications apply over all operating input voltage, load, and temperature conditions.

INPUT					
Parameter	Symbol	Min	Typ	Max	Unit
Operational Range	V _{IN}	85	115/230	264	V _{AC}
Frequency Range (ETSI 300-132-1 recommendation)	F _{IN}	47	50/60	63	Hz
Main Output Turn OFF	V _{IN}	75		82	V _{AC}
Main Output Turn ON		80		88	
Hysteresis between turn OFF and turn ON		3	5		
Maximum Input Current (V _O = V _{O, set} , I _O =I _{O, max}) V _{IN} = 100V _{AC} V _{IN} = 180V _{AC}	I _{IN}			15.5 12.5	A _{AC}
Cold Start Inrush Current (Excluding x-caps, 25°C, <10ms, per ETSI 300-132)	I _{IN}			40	A _{PEAK}
Efficiency (T _{amb} =25°C, V _O = 12V) V _{IN} 100% load 50% load 20% load 10% load	η		115V / 230V 92 / 92.0 93 / 94.0 91 / 93.0 85 / 90.5		%
Power Factor (V _{IN} =115/230V _{AC} , I _O = 50% I _{O, max} I _O = I _{O, max})	PF		0.98 0.99		
Holdup time (V _{out} = 12.0V _{DC} , T _{amb} 25°C, I _O =80% I _{O, max}) V _{in} = 230V _{AC} V _{in} = 100V _{AC}	T		12 20		ms
Early warning prior to output falling below regulation ¹ (V _{out} = 12.0V _{DC} , T _{amb} 25°C, I _O =80% I _{O, max})		2			
Ride through	T		10		
Leakage Current (V _{IN} = 250V _{AC} , F _{IN} = 60Hz)	I _{IN}	3			mA _{RMS}
Isolation Input/Output		3000			V _{AC}
Input/Frame		2121			V _{DC}
Output/Frame		100			V _{DC}

12V _{dc} MAIN OUTPUT					
Parameter	Symbol	Min	Typ	Max	Unit
Output Power 180 – 264 / 90-132 Vac V _{AC} ≤ 90V _{AC}	W	0 0	- -	2000/1300 1200	W W
Set point	V _O	11.9	12.00	12.1	V _{DC}
Overall regulation (load, temperature)		-2		+2	%

¹ Measured by the DC_OK signal going LO prior to the output decaying below 10.8Vdc

CAR2012TE series rectifier

Input: 85Vac to 264Vac; Output: 12 Vdc @ 2000W; 3.3Vdc or 5 Vdc @ 4A

12V _{dc} MAIN OUTPUT (continued)					
Parameter	Symbol	Min	Typ	Max	Unit
Ripple and noise ² at 25°C, (relaxed to 150mV _{p-p} below 0°C)				120	mV _{p-p}
Turn-ON overshoot				+3	%
Turn-ON delay	T			2	sec
Remote ON/OFF delay time				40	ms
Turn-ON rise time (10 – 90% of V _{out})				50	ms
Transient response 50% step [10%-60%, 50% - 100%] (di/dt – 1A/μs, recovery 300μs)		-5		+5	%V _o
Programmable range (hardware & software)	V _o	10.8		13.2	V _{DC}
Overvoltage protection, latched (recovery by cycling OFF/ON via hardware or software)		13.8	14.8	15.8	V _{DC}
Output current 180 ≥ V _{IN} ≥ 264 90 ≥ V _{IN} ≥ 132		0		167 108	A _{DC}
Current limit, Hiccup (programmable level)	I _o	110		130	% of FL
Active current share, (I _o ≥ 20% of I _{o,MAX})		-5		+5	% of FL

STANDBY OUTPUT					
Parameter	Symbol	Min	Typ	Max	Unit
Set point	V _o		3.3 / 5.0		V _{DC}
Overall regulation (load, temperature, aging)	V _o	-5		+5	%
Ripple and noise, STANDBY CLOCK – I ² C DATA – I ² C				100	mV _{p-p}
Output current [3.3V / 5V]	I _o	0		4 / 3	A _{DC}
Overload protection -		110		150	% of FL
Isolation Output/Frame		100			V _{DC}

General Specifications

Parameter	Min	Typ	Max	Units	Notes
Reliability, 25°C 50°C		1,485,480 644,875		Hrs	Full load, ; MTBF per Telecordia SR232 Issue 3: Reliability protection for electronic equipment, method I, case III,
Service Life		10		Yrs	Full load, excluding fans
Weight					

Feature Specifications

Unless otherwise indicated, specifications apply over all operating input voltage, resistive load, and temperature conditions. See Feature Descriptions for additional information.

Parameter	Symbol	Min	Typ	Max	Unit
Remote ON/OFF (pulled up internally within the module)					
Logic High (Module ON)		0.7V _{STDBY}		V _{STDBY}	V _{DC}
Logic Low (Module OFF)	I _{IL} V _{IL}	— 0	—	1 0.8	mA V _{DC}

² Measured across a 10μf tantalum and a 0.1μf ceramic capacitors in parallel. 20MHz bandwidth

CAR2012TE series rectifier

Input: 85Vac to 264Vac; Output: 12 Vdc @ 2000W; 3.3Vdc or 5 Vdc @ 4A

Feature Specifications (continued)

Parameter	Symbol	Min	Typ	Max	Unit
Output Voltage programming (Vprog)					
Equation: $V_{out} = 10.8 + (V_{prog} * 0.96)$					
Vprog range	V_{prog}	0	—	2.5	V_{DC}
Programmed output voltage range	V_o	10.8	—	13.2	V_{DC}
Voltage adjustment resolution (8-bit A/D)	V_o	—	10	—	mV _{DC}
Output configured to 13.2Vdc	V_{prog}	2.5	—	3.0	V_{DC}
Output configured to the 12Vdc set-point	V_{prog}	3.0	—	—	V_{DC}
Interlock [short pin controlling presence of the 12V _{DC} output]					
12V output OFF	V_i	0.7V _{DD}	—	12	V_{DC}
12V output ON	V_i	0	—	0.8	V_{DC}
AC-OK (internally pulled up to Stndby via a 10kΩ resistor)					
Logic High (Input within normal range)	I_{OH}	—	—	20	μA
	V_{OH}	0.7V _{DD}	—	12	V_{DC}
Logic Low (Input out of range)	I_{OL}	—	—	4	mA
	V_{OL}	0	—	0.4	V_{DC}
DC-OK (internally pulled up to Stndby via a 10kΩ resistor)					
Logic High (Output voltage is present; $V_{OUT} \geq 10.7V_{dc}$)	I_{OH}	—	—	20	μA
	V_{OH}	0.7V _{DD}	—	12	V_{DC}
Logic Low (Output voltage is not present; $V_{OUT} \leq 10.2V_{dc}$)	I_{OL}	—	—	4	mA
	V_{OL}	0	—	0.4	V_{DC}
OT Warning (internally pulled up to Stndby via a 10kΩ resistor)					
Logic High (temperature within normal range)	I_{OH}	—	—	20	μA
	V_{OH}	0.7V _{DD}	—	12	V_{DC}
Logic Low (temperature is too high)	I_{OL}	—	—	4	mA
	V_{OL}	0	—	0.4	V_{DC}
Delayed shutdown after Logic Low transition	Tdelay	10	—	—	sec
Fault (internally pulled up to Stndby via a 10kΩ resistor)					
Logic High (No fault is present)	I_{OH}	—	—	20	μA
	V_{OH}	0.7V _{DD}	—	12	V_{DC}
Logic Low (Fault is present)	I_{OL}	—	—	4	mA
	V_{OL}	0	—	0.4	V_{DC}
PS Present (connected to output GRD inside the power supply)					
Logic High (Power supply is not plugged in)					
Logic Low (Power supply is present)	V_{iL}	0	—	0.1	V_{DC}

CAR2012TE series rectifier

Input: 85Vac to 264Vac; Output: 12 Vdc @ 2000W; 3.3Vdc or 5 Vdc @ 4A

Feature Specifications (continued)

Parameter	Symbol	Min	Typ	Max	Unit
SMBAlert# (Interrupt) (must be pulled up externally to Stndby)					
Logic High (No Alert - normal)	I_{OH}		—	20	μA
	V_{OH}	$0.7V_{DD}$	—	12	V_{DC}
Logic Low (Alert is set)	I_{OL}	—	—	4	mA
	V_{OL}	0	—	0.4	V_{DC}
Output current monitor (I _{mon})					
Resolution			18		mV/A
Measurement range	I_o	0		167	A _{DC}
Measurement accuracy, load > 25% of FL, $V_o = 12V_{DC}$		-4		+4	%
Analog output range	V_{mon}	0		3.3	V_{DC}
Sourced output current	I_o			5	mA _{DC}

Digital Interface Specifications

Parameter	Conditions	Symbol	Min	Typ	Max	Unit
PMBus Signal Interface Characteristics						
Input Logic High Voltage (CLK, DATA)		V_{IH}	$0.7V_{DD}$		3.6	V
Input Logic Low Voltage (CLK, DATA)		V_{IL}	0		0.8	V
Input high sourced current (CLK, DATA)		I_{IH}	0		10	μA
Output Low sink Voltage (CLK, DATA, SMBALERT#)	$I_o=5mA$	V_{OL}			0.4	V
Output Low sink current (CLK, DATA, SMBALERT#)		I_{OL}	5			mA
Output High leakage current (CLK, DATA, SMBALERT#)	$V_o=3.6V$	I_{OH}	0		10	μA
PMBus Operating frequency range		F _{PMB}	10		400	kHz
Measurement System Characteristics						
Clock stretching		t _{STRETCH}			25	ms
I_{OUT} measurement range	Linear mode	I_{RNG}	0		167	A
I_{OUT} measurement accuracy 25°C	$I_{OUT} \geq 10\% FL$	$I_{OUT(ACC)}$	-5		+5	%
	$I_{OUT} < 10\% FL$		-3		+3	A
V_{OUT} measurement range	Linear mode	$V_{OUT(RNG)}$	0		14	V
V_{OUT} measurement accuracy		$V_{OUT(ACC)}$	-5		+5	%
Temp measurement range	Linear mode	Temp _(RNG)	0		125	°C
Temp measurement accuracy ³		Temp _(ACC)	-5		+5	%
I_{IN} measurement range	Linear mode	$I_{IN(RNG)}$	0		18	A _{rms}
I_{IN} measurement accuracy	$I_{IN} \geq 20\% FL$	$I_{IN(ACC)}$	-5		+5	%
	$10\% \leq I_{IN} < 20\% FL$		-10		+10	%
	$I_{IN} < 10\% FL$		-0.2		+0.2	A
V_{IN} measurement range	Linear mode	$V_{IN(RNG)}$	0		300	V_{rms}
V_{IN} measurement accuracy		$V_{IN(ACC)}$	-5		+5	%
P_{IN} measurement range	Linear mode	$P_{IN(RNG)}$	0		3000	W
P_{IN} measurement accuracy	$P_{IN} \geq 10\% FL$	$P_{IN(ACC)}$	-5		+5	%
	$P_{IN} < 10\% FL$		-10		+10	W
Fan Speed measurement range	Linear mode		0		30k	RPM
Fan Speed measurement accuracy			-10		10	%
Fan speed control range			0		100	%

³ Temperature accuracy reduces non-linearly with decreasing temperature

CAR2012TE series rectifier

Input: 85Vac to 264Vac; Output: 12 Vdc @ 2000W; 3.3Vdc or 5 Vdc @ 4A

Environmental Specifications

Parameter	Min	Typ	Max	Units	Notes
Ambient Temperature	-10		70	°C	Derated above 50°C
Storage Temperature	-40		85	°C	
Operating Altitude			2250/7382	m/ft	
Non-operating Altitude			8200/30k	m / ft	
Power Derating with Temperature			2.5	%/°C	50°C to 70°C ⁴
Power Derating with Altitude			2.0	°C/301 m °C/1000 ft	Above 2250 m/7382 ft
Acoustic noise		55 45		dbA	Full load Half load
Over Temperature Protection		125/110		°C	Shutdown / restart
Humidity Operating Storage	30 10		95 95	%	Relative humidity, non-condensing
Shock and Vibration	Meet IPC 9592 Class II, Section 5 requirements				

EMC Compliance

Parameter	Function	Standard	Level	Criteria	Test
AC input	Conducted emissions	EN55022, FCC part 15 EN61000-3-2	A*		0.15 – 30MHz 0 – 2 KHz
	Radiated emissions**	EN55022	A*		30 – 10000MHz
AC input immunity	Voltage dips	EN61000-4-11		A	-30%, 10ms
				B	-60%, 100ms
				B	-100%, 5sec
	Voltage surge	EN61000-4-5		A	4kV, 1.2/50µs, common mode
Fast transients	EN61000-4-4		A	2kV, 1.2/50µs, differential mode	
			A	5/50ns, 2kV (common mode)	
Enclosure immunity	Conducted RF fields	EN61000-4-6	A		130dBµV, 0.15-80MHz, 80% AM
	Radiated RF fields	EN61000-4-3	A		10V/m, 80-1000MHz, 80% AM
		ENV 50140	A		
	ESD	EN61000-4-2	B		4kV contact, 8kV air

* Note: Contact the factory for a recommended external EMI filter to meet Class B emissions
 ** Radiated emissions compliance is contingent upon the final system configuration.

Criteria	Performance
A	No performance degradation
B	Temporary loss of function or degradation not requiring manual intervention
C	Temporary loss of function or degradation that may require manual intervention
D	Loss of function with possible permanent damage

⁴ The maximum operational ambient is reduced in Europe in order to meet certain power cord maximum ratings of 70°C. The maximum operational ambient where 70°C rated power cords are utilized is reduced to 60°C until testing demonstrates that a higher level is acceptable.

CAR2012TE series rectifier

Input: 85Vac to 264Vac; Output: 12 Vdc @ 2000W; 3.3Vdc or 5 Vdc @ 4A

Characteristic Curves

The following figures provide typical characteristics for the CAR2012DC converter at 25°C

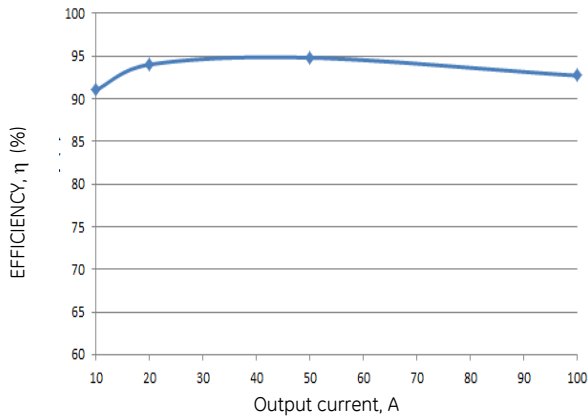

Figure 1. Converter Efficiency versus Output Current.

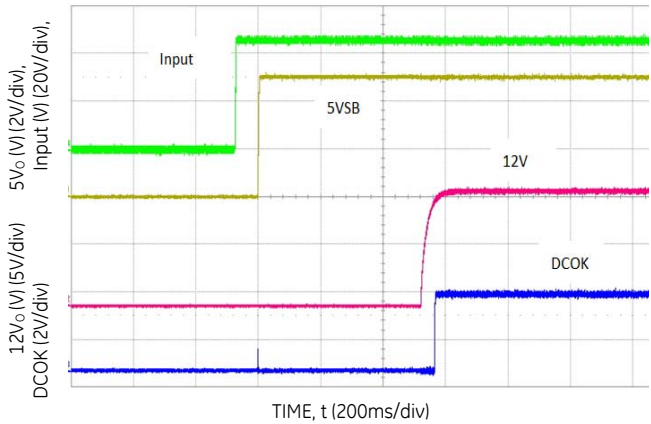

Figure 2. Input start up (Vin: -48V_{DC}, full load).

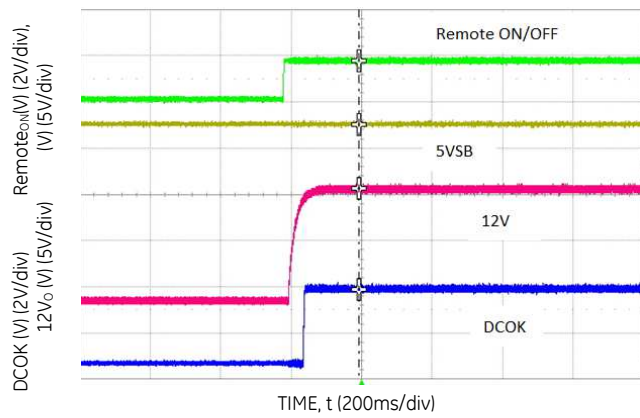

Figure 3. Start-up Using Remote On/OFF (Vin: -48V_{DC}, full load)

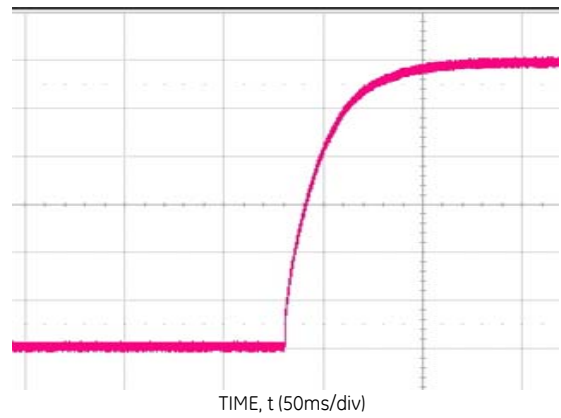

Figure 4. 12V start-up (Vin: -48V_{DC}, full load)

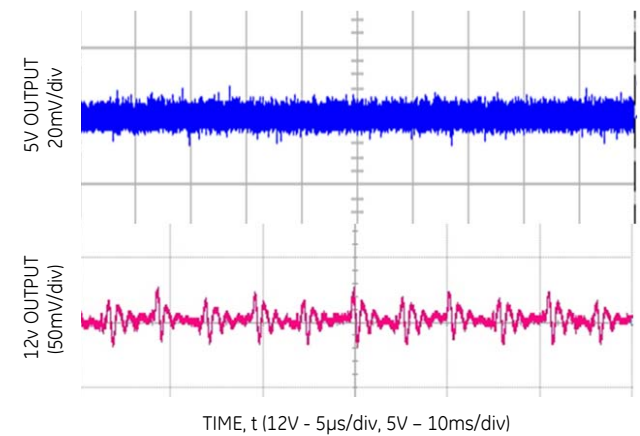

Figure 5. 12V output ripple and noise (Vin: -48V_{DC}, full load).

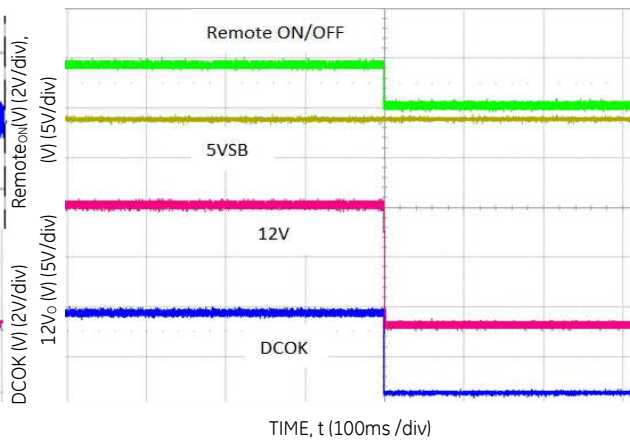

Figure 6. Turn-OFF via Remote ON/OFF (Vin: -48V_{DC}, full load)

CAR2012TE series rectifier

Input: 85Vac to 264Vac; Output: 12 Vdc @ 2000W; 3.3Vdc or 5 Vdc @ 4A

Characteristic Curves (continued)

The following figures provide typical characteristics for the CAR2012DC converter at 25°C.

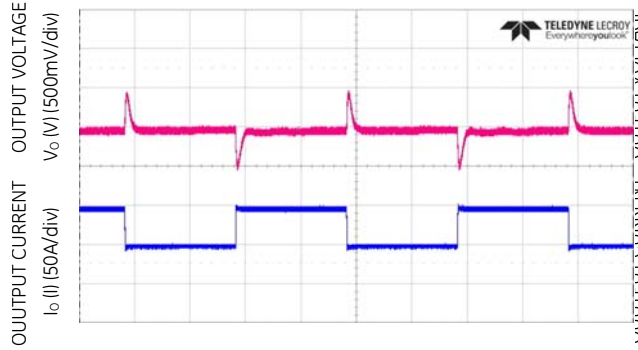

TIME, t (5ms/div)

Figure 7. Transient response 12V_{DC} output load step 10 – 60A, V_{IN} = -48V_{DC}.

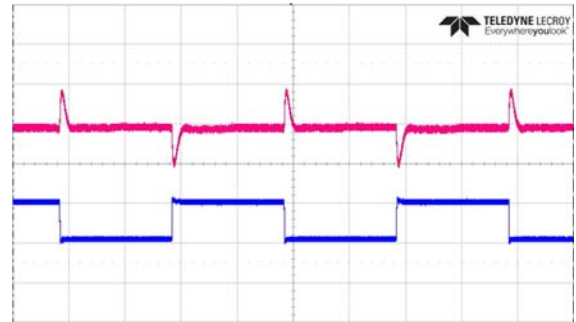

TIME, t (5ms/div)

Figure 8. Transient response 12V_{DC} output load step 50 – 100A, V_{IN} = -48V_{DC}.

SYSTEM CURRENT STEPS	% LOAD	I total(A)	I UNIT #1	I UNIT #2	% I share
	100	200	96.89	102.6	2.8%
75	150	72.56	78.21	2.8%	
50	100	47.46	52.64	2.5%	
30	60	28.41	32.61	2.1%	
20	40	18.42	21.83	1.7%	

TOTAL & INDIVIDUAL CURRENT READINGS / %ISHARE

Table 9. Current share between two modules

	NO LOAD	FULL LOAD
	25 °C	25 °C
Turn on point(V)	34.9	34.9
Turn off point(V)	30.5	30.8
Hysteresis(V)	4.4	4.1

Table 10. Input Turn OFF and Turn ON.

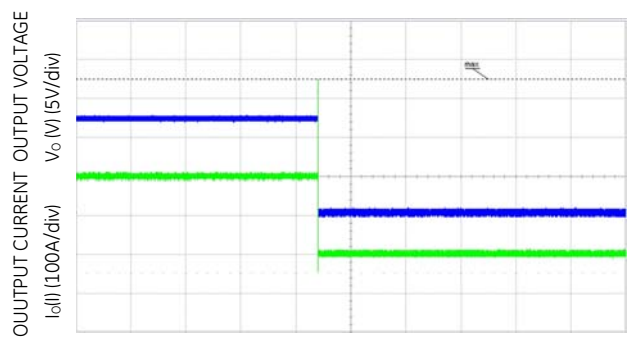

TIME, t (500ms/div)

Figure 11. Overload: output short circuit performance, the unit is in latch_OFF mode. , V_{IN} = -48V_{DC}.

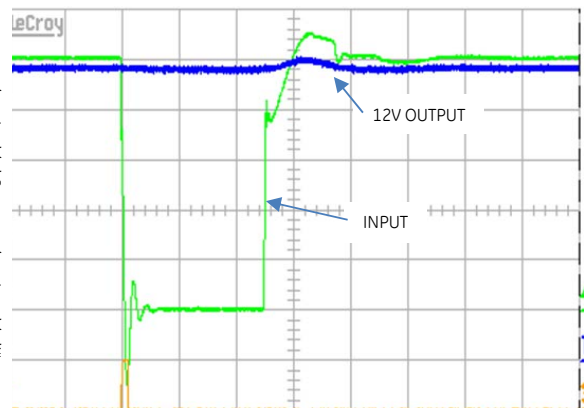

TIME, t (1ms/div)

Figure 12. Ride through: full load Vin = -48V_{DC}

Control and Status

Control hierarchy: Some features, such as output voltage, can be controlled both through hardware and firmware. For example, the output voltage is controlled both by a signal pin (Vprog) and a PMBus command, (OPERATION).

Unless otherwise noted, the signal pin controls the feature until the firmware command is executed. However, once the firmware command has been executed, the signal pin is ignored. In the above example, the power supply will no longer 'listen' to the Vprog pin if the OPERATION command has been executed.

In summary, Vprog is utilized for initialized configuration of the output voltage and to change the output voltage when PMBus is not used for that function.

Analog controls: Details of analog controls are provided in this data sheet under Signal Definitions.

Common ground: All signals and outputs are referenced to Output return. These include 'Vstb return' and 'Signal return'.

Delayed overcurrent shutdown during startup: Power supplies are programmed to stay in a constant current state for up to 20 seconds during power up. This delay has been introduced to permit the orderly application of input power to a subset of paralleled front-ends during power up. If the overload persists beyond the 20 second delay, the front-end will revert back into its programmed state of overload protection.

Unit in Power Limit or in Current Limit: When output voltage is > 10V_{DC} the Output LED will continue blinking. When output voltage is < 10V_{DC}, if the unit is in the RESTART mode, it goes into hiccup. When the unit is ON the output LED is ON, when the unit is OFF the output LED is OFF.

When the unit is in latched shutdown the output LED is OFF.

Auto_restart: Auto-restart is the default configuration for over-current and over-temperature shutdowns. These features are configured by the PMBus™ fault_response commands

An overvoltage shutdown is followed by three attempted restarts, each restart delayed 1 second, within a 1 minute window. If within the 1 minute window three attempted restarts failed, the unit will latch OFF. If within the 1 minute less than 3 shutdowns occurred then the count for latch OFF resets and the 1 minute window starts all over again.

Restart after a latchoff: PMBus™ fault_response commands can be configured to direct the power supply to remain latched off for over_temperature and over_current.

To restart after a latch off either of five restart mechanisms are available.

1. The hardware pin **Remote ON/OFF** may be cycled OFF and then ON.

2. The unit may be commanded to restart via i2c through the *Operation* command by cycling the output OFF followed by ON.
3. Remove and reinsert the unit.
4. Turn OFF and then turn ON AC power to the unit.
5. Changing firmware from **latch off** to **restart**.

Each of these commands must keep the power supply in the OFF state for at least 2 seconds, with the exception of changing to **restart**.

A successful restart shall clear all alarm registers, set the **restarted successful** bit of the **Status_2** register.

A power system that is comprised of a number of power supplies could have difficulty restarting after a shutdown event because of the non-synchronized behavior of the individual power supplies. Implementing the latch-off mechanism permits a synchronized restart that guarantees the simultaneous restart of the entire system.

A synchronous restart can be implemented by;

1. Issuing a GLOBAL OFF and then ON command to all power supplies,
2. Toggling Off and then ON the ENABLE signal
3. Removing and reapplying input commercial power to the entire system.

The power supplies should be turned OFF for at least 20 – 30 seconds in order to discharge all internal bias supplies and reset the soft start circuitry of the individual power supplies.

Control Signals

MCU Device address: Address bits A2, A1, A0 configure the specific address of the power supply. With these four bits, up to sixteen (8) modules to be addressed on a single I²C bus. The pins are pulled HI internal to the power supply. For a logic LO these pins should be connected to 'Output Return'. The least significant bit x (LSB) of the address byte is set to either write [0] or read [1]. A **write** command instructs the power supply. A **read** command accesses information from the power supply.

Device	Address	Address Bit Assignments (Most to Least Significant)							
MCU	Cx	1	1	0	0	A2	A1	A0	R/W
Broadcast	00	0	0	0	0	0	0	0	0

Global Broadcast: This is a powerful command because it instruct all power supplies to respond simultaneously.. A **read** instruction should never be accessed globally. The power supply should issue a 'invalid command' state if a 'read' is attempted globally.

For example, changing the 'system' output voltage requires this capability so that all paralleled power supplies change their output simultaneously. This command can also turn OFF the 'main' output or turn ON the 'main' output of all power supplies simultaneously. Unfortunately, this command does have a side effect. Only a single power supply needs to pull down the ninth *acknowledge* bit. To be certain that each power supply responded to the global instruction, a **READ**

CAR2012TE series rectifier

Input: 85Vac to 264Vac; Output: 12 Vdc @ 2000W; 3.3Vdc or 5 Vdc @ 4A

instruction should be executed to each power supply to verify that the command properly executed.

Voltage programming (V_{prog}): An analog voltage on this signal can vary the output voltage $\pm 10\%$ from 10.8Vdc to 13.2Vdc.

Hardware voltage programming controls the output voltage until a software margin command is executed. Software voltage programming (margining) permanently overrides the hardware margin setting and the power supply no longer listens to any hardware margin settings until power to the controller is interrupted, for example if input power or bias power is recycled.

When bias power is recycled to the controller the controller restarts into its default configuration, programmed to set the output as instructed by the V_{prog} pin. Again, subsequent software commanded settings permanently override the margin setting. As an example, adding a resistor between V_{prog} and Output_return is an effective way of changing the factory set point of the rectifier to whatever voltage level is desired by the user during initial start-up.

Load share (I_{share}): This is a single wire analog signal that is generated and acted upon automatically by power supplies connected in parallel. I_{share} pins should be connected to each other for power supplies, if active current share among the power supplies is desired. No resistors or capacitors should get connected to this pin.

Remote ON/OFF: Controls the presence of the main 12Vdc output voltage. This is an open collector signal that needs to be pulled HI externally through a resistor.

A turn OFF command either through this signal (Remote ON/OFF) or firmware commanded would turn OFF the 12V output.

Interlock: This is a short signal pin that controls the presence of the 12Vdc main output. This pin should be connected to 'output return' on the system side of the output connector. The purpose of this pin is to ensure that the output turns ON after engagement of the power blades and turns OFF prior to disengagement of the power blades.

Status signals

Output current monitor (I_{mon}): A voltage level of $3V = 167A$, or $18mV/A$, proportional to the delivered output current is present on this pin.

AC OK: A TTL compatible status signal representing whether the input voltage is within the anticipated range. This signal needs to be pulled HI externally through a resistor.

DC OK: A TTL compatible status signal representing whether the output voltage is present. This signal needs to be pulled HI externally through a resistor.

Over temp warning: A TTL compatible status signal representing whether an over temperature exists. This signal needs to be pulled HI externally through a resistor.

If an over temperature should occur, this signal would pull LO for approximately 10 seconds prior to shutting down the power supply. In its default configuration, the unit would restart if internal temperatures recover within normal operational levels. At that time the signal reverts back to its open collector (HI) state.

Fault: A TTL compatible status signal representing whether a Fault occurred.

This signal activates for internal power supply failures such as over temperature or over voltage shutdown.

PS Present: This pin is connected to 'output return' within the power supply. Its intent is to indicate to the system that a power supply is present.

Serial Bus Communications

The I²C interface facilitates the monitoring and control of various operating parameters within the unit and transmits these on demand over an industry standard I²C Serial bus.

All signals are referenced to 'Signal Return'.

Pull-up resistors: The clock, data, and SMBusAlert# lines do not have any internal pull-up resistors inside the power supply. The customer is responsible for ensuring that the transmission impedance of the communications lines complies with I²C and SMBus standards.

Serial Clock (SCL): The clock pulses on this line are generated by the host that initiates communications across the I²C Serial bus. This signal needs to be pulled HI externally through a resistor as necessary to ensure that rise and fall time timing and the maximum sink current is in compliance to the I²C /SMBus specifications.

Serial Data (SDA): This line is a bi-directional data line. This signal needs to be pulled HI externally through a resistor as necessary to ensure that rise and fall time timing and the maximum sink current is in compliance to the I²C /SMBus specifications.

SMBUSAlert#: This hardware signal pin is normally HI. When asserted (logic LO) it signifies to the system controller that the state of the power supply has changed or that communication errors occurred.

Basic Operation

PMBus™ compliance: The power supply is fully compliant to the Power Management Bus (PMBus™) rev1.2 requirements.

The power supply clears the STATUS and ALARM registers and the SMBAlert# signal after a successful read back of the information in these registers, with the exception of communications error alarms (PEC error, data error, command error). If the alarm state is still present the status

CAR2012TE series rectifier

Input: 85Vac to 264Vac; Output: 12 Vdc @ 2000W; 3.3Vdc or 5 Vdc @ 4A

and alarm registers get reset into their alarm state, however, the SMBAlert# does not assert again.

'Manufacturer Specific' commands are used to support instructions that are not offered by the PMBus™ specification. All communication over the PMBus interface must support Packet Error Checking (PEC). The PMBus master must generate the correct PEC byte for all transactions, and check the PEC byte returned by the power supply.

Non-volatile memory is used to store configuration settings. Not all settings programmed into the device are automatically saved into this non-volatile memory. Only those specifically identified as capable of being stored can be saved. (see the Table of Commands for which command parameters can be saved to non-volatile storage).

Default state: Power supplies are programmed in the default state to automatically restart after a shutdown has occurred for over current and over temperature. The default state can be reconfigured by changing non-volatile memory (Store_default_code).

Re-initialization: The I²C code is programmed to re-initialize if no activity is detected on the bus for 5 seconds. Re-initialization is designed to guarantee that the I²C μController does not hang up the bus. Although this rate is longer than the timing requirements specified in the SMBus specification, it had to be extended in order to ensure that a re-initialization would not occur under normal transmission rates. During the few μseconds required to accomplish re-initialization the I²C μController may not recognize a command sent to it. (i.e. a start condition).

Read back delay: The power supply issues the SMBAlert # notification as soon as the first state change occurred. During an event a number of different states can be transitioned to before the final event occurs. If a read back is implemented rapidly by the host a successive SMBAlert# could be triggered by the transitioning state of the power supply. In order to avoid successive SMBAlert#s and read back and also to avoid reading a transitioning state, it is prudent to wait more than 2 seconds after the receipt of an SMBAlert# before executing a read back. This delay will ensure that only the final state of the power supply is captured.

Successive read backs: Successive read backs to the power supply should not be attempted at intervals faster than every one second. This time interval is sufficient for the internal processors to update their data base so that successive reads provide fresh data.

Non-supported commands: Non supported commands are flagged by setting the appropriate STATUS bit and issuing an SMBAlert# to the 'host' controller. If a non-supported read is requested the power supply will return 0x00h for data.

Data out-of-range: The power supply validates data settings and sets the data out-of-range bit and SMBAlert# if the data is not within acceptable range.

Master/Slave: The 'host controller' is always the MASTER. Power supplies are always SLAVES. SLAVES cannot initiate

communications or toggle the Clock. SLAVES also must respond expeditiously at the command of the MASTER as required by the clock pulses generated by the MASTER.

Clock stretching: The 'slave' μController inside the power supply may initiate clock stretching if it is busy and it desires to delay the initiation of any further communications. During the clock stretch the 'slave' may keep the clock LO until it is ready to receive further instructions from the host controller. The maximum clock stretch interval is 25ms.

The host controller needs to recognize this clock stretching, and refrain from issuing the next clock signal, until the clock line is released, or it needs to delay the next clock pulse beyond the clock stretch interval of the power supply.

Note that clock stretching can only be performed after completion of transmission of the 9th ACK bit, the exception being the START command.

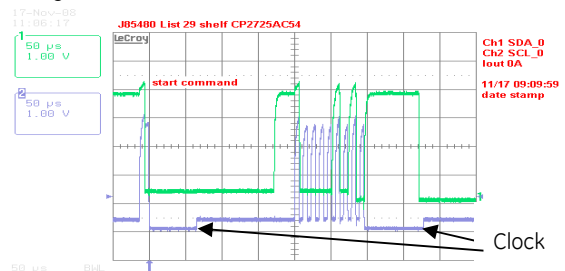

Figure 1. Example waveforms showing clock stretch

I²C Bus Lock-Up detection: The device will abort any transaction and drop off the bus if it detects the bus being held low for more than 35ms.

Communications speed: Both 100kHz and 400kHz clock rates are supported. The power supplies default to the 100kHz clock rate. The minimum clock speed specified by SMBus is 10 kHz.

Packet Error Checking (PEC): The power supply will not respond to commands without the trailing PEC because the integrity of communications is compromised without packet error correction deployment.

PEC is a CRC-8 error-checking byte, based on the polynomial $C(x) = x^8 + x^2 + x + 1$, in compliance with PMBus™ requirements. The calculation is performed on all message bytes, including the originating write address and command bytes preceding read instructions. The PEC is appended to the message by the device that supplied the last byte.

SMBAlert#: The μC driven SMBAlert# signal informs the 'master/host' controller that either a STATE or ALARM change has occurred. Normally this signal is HI. The signal will change to its LO level if the power supply has changed states and the signal will be latched LO until the power supply receives a 'clear' instruction as outlined below. If the alarm state is still present after the 'clear_faults' command has been received, then the signal will revert back into its LO state again and will latch until a subsequent 'clear_faults' signal is received from the host controller.

CAR2012TE series rectifier

Input: 85Vac to 264Vac; Output: 12 Vdc @ 2000W; 3.3Vdc or 5 Vdc @ 4A

The signal will be triggered for any state change whether a 'warning' or a 'fault', including the following conditions;

- VIN under or over voltage
- Vout under or over voltage
- IOOUT over current
- Over Temperature
- Fan Failure
- Communication error
- PEC error
- Invalid command
- Detected internal faults

The power supply will clear the SMBusAlert# signal (release the signal to its HI state) upon the following events:

- Receiving a CLEAR_FAULTS command
- Input power and bias power to the processor is recycled

The power supply will clear the SMBusAlert# signal (release the signal to its HI state) for operational alarms (but not communications alarms that require a clear_faults signal from the controller that it received the alert) upon the following events:

- The main output recycled (turned OFF and then ON) via the Remote_ON/OFF or INTERLOCK signal pins
- The main output recycled (turned OFF and then ON) by the OPERATION command

Standard instruction: Up to two bytes of data may follow an instruction depending on the required data content. Analog data is always transmitted as LSB followed by MSB. PEC is optional and includes the address and data fields.

1	8	1	8	1
S	Slave address	Wr	Command Code	A

8	1	8	1	8	1	1
Low data byte	A	High data byte	A	PEC	A	P

Master to Slave Slave to Master

SMBUS annotations; S – Start, Wr – Write, Sr – re-Start, Rd – Read,

A – Acknowledge, NA – not-acknowledged, P – Stop

Standard READ: Up to two bytes of data may follow a READ request depending on the required data content. Analog data is always transmitted as LSB followed by MSB. PEC is mandatory and includes the address and data fields.

1	7	1	1	8	1
S	Slave address	Wr	A	Command Code	A

1	7	1	1	8	1
Sr	Slave Address	Rd	A	LSB	A

8	1	8	1	1
MSB	A	PEC	No-ack	P

Block communications: When writing or reading more than two bytes of data at a time BLOCK instructions for WRITE and READ commands are used instead of the Standard Instructions above to write or read any number of bytes greater than two.

Block write format:

1	7	1	1	8	1
S	Slave address	Wr	A	Command Code	A

8	1	8	1	8	1
Byte count = N	A	Data 1	A	Data 2	A

8	1	8	1	8	1	1
.....	A	Data N ≤ 48	A	PEC	A	P

Block read format:

1	7	1	1	8	1
S	Slave address	Wr	A	Command Code	A

1	7	1	1
Sr	Slave Address	Rd	A

8	1	8	1	8	1
Byte count = N	A	Data 1	A	Data 2	A

8	1	8	1	8	1	1
.....	A	Data N ≤ 48	A	PEC	NoAck	P

An example of the block_read instruction is the **Read_std_parameters (D0h)** command. This 'manufacturer specific' command returns STATUS and ALARM register data, output voltage, output current, and internal temperature in a single read string.

1	8	1	8	1
S	Slave address	Wr	A	Command Code

1	8	1	8	1
Sr	Slave address	Rd	A	Byte count = 11

8	1	8	1	8	1
Status-2	A	Status-1	A	Alarm-2	A

8	1	8	1	8	1
Alarm-1	A	Voltage LSB	A	Voltage MSB	A

8	1	8	1
Current LSB	A	Current MSB	A

8	1	8	1	8	1	1
Temperature LSB	A	Temperature MSB	A	PEC	NA	P

Linear Data Format The definition is identical to Part II of the PMBus Specification. All standard PMBus values, with the exception of output voltage related functions, are represented by the linear format described below. Output voltage functions are represented by a 16 bit mantissa. The value of the exponent for output voltage functions is listed in the Vout_mode command.

CAR2012TE series rectifier

Input: 85Vac to 264Vac; Output: 12 Vdc @ 2000W; 3.3Vdc or 5 Vdc @ 4A

The Linear Data Format is a two byte value with an 11-bit, two's complement mantissa and a 5-bit, two's complement exponent or scaling factor, its format is shown below.

Data Byte High					Data Byte Low											
Bit	7	6	5	4	3	2	1	0	7	6	5	4	3	2	1	0
Exponent (E)					Mantissa (M)											

The relationship between the Mantissa, Exponent, and Actual Value (V) is given by the following equation:

$$V = M * 2^E$$

Where:

V is the value

M is the 11-bit, two's complement mantissa

E is the 5-bit, two's complement exponent

Standard features

Command	Comments
ON_OFF_CONFIG	Both the CNTL pin, enabling or disabling the output, and the OPERATION command are supported. Other options are not supported.
Vout_OV_fault_response	Only latched (0x80) is supported
CAPABILITY	400KHz, SMBALERT
PMBus revision	1.2

PMBus™ Command set:

Non-supported commands are annunciated.

Command	Hex Code	Data Byte	Function
Operation	0x01	1	Output ON/OFF
ON_OFF_config	0x02	1	09, output ON default
Clear_faults	0x03	0	Clear Status
Write_protect	0x10	1	Write control
Restore_default_all	0x12	0	Reset defaults
Store_user_code	0x17	1	Change default state
Restore_user_code	0x18	1	Restore user state
Vout_mode	0x20	1	Vout constants
Vout_command	0x21	2	Set Vout
Fan_command_1	0x3B	2	Set fan speed in %
Vout_OV_fault_limit	0x40	2	Set OV fault limit
Vout_OV_warn_limit	0x42	2	Set OV warn limit
Iout_OC_fault_limit	0x46	2	
Iout_OC_fault_response ⁵	0x47	1	Latch or hiccup
Iout_OC_warn_limit	0x4A	2	Set OC warn limit
OT_fault_limit	0x4F	2	
OT_fault_response ⁶	0x50	1	Latch or hiccup
OT_warn_limit	0x51	2	Set OT warn limit
Status_byte	0x78	1	
Status_word	0x79	2	
Status_Vout	0x7A	1	
Status_Iout	0x7B	1	
Status_input	0x7C	1	
Status_temperature	0x7D	1	
Status_CML	0x7E	1	
Status_fan_1_2	0x81	1	

⁵ Only latched (0xC0) or hiccup (0xF8) are supported

⁶ Only latched (0x80) or restart (0xC0) are supported

Command	Hex Code	Data Byte	Function
Read_lin	0x89	2	
Read_Vout	0x8B	2	
Read_Iout	0x8C	2	
Read_temperature	0x8D	2	
Read_fan_speed_1	0x90	2	
Read_fan_speed_2	0x91	2	
Read_Pin	0x97	2	
Mfr_ID	0x99	5	
Mfr_model	0x9A	16	CAR2012TEXXXZ01A
Mfr_serial	0x9E	15	01KZ51018193xxx
Read_Std_Parameters	0xD0	10	
Read_Status_State	0xD1	2	
Read_Alarm_State	0xD2	2	
Read_fan_speed	0xD3	4	
Read_Input_string	0xD4	2	
Read_mfr_rev	0xD5	4	
Read_Run_Timer	0xD6	3	
EEPROM_record	0xD9	64	
Test Function	0xDF	1	

Command Descriptions

Operation (0x01) : By default the Power supply is turned **ON** at power up as long as *Power ON/OFF* signal pin is active HI. The Operation command is used to turn the Power Supply ON or OFF via the PMBus. The data byte below follows the OPERATION command.

FUNCTION	DATA BYTE
Unit ON	80
Unit OFF	00

To **RESET** the power supply cycle the power supply OFF, wait at least 2 seconds, and then turn back ON. All alarms and shutdowns are cleared during a restart.

Clear_faults (0x03): This command clears all STATUS and FAULT registers and resets the SMBAlert# line. If a fault still persists after the issuance of the clear_faults command the specific registers indicating the fault are reset and the SMBAlert# line is activated again.

WRITE_PROTECT register (0x10): Used to control writing to the PMBus device. The intent of this command is to provide protection against accidental changes. All supported command parameters may have their parameters read, regardless of the write_protect settings. The default setting of this register is disable_all_writes except write_protect. 0x80h.

FUNCTION	DATA BYTE
Enable all writes	00
Disable all writes except write_protect	80
Disable all writes except write_protect and OPERATION	40

CAR2012TE series rectifier

Input: 85Vac to 264Vac; Output: 12 Vdc @ 2000W; 3.3Vdc or 5 Vdc @ 4A

Restore_Default_All (0x12): Restores all register values and responses to the default parameters set in the power supply.

Store_default_code (0x13): Default values desired to be overwritten must be executed one at a time. In this fashion some protection is offered to ensure that only those values that are desired to be changed are in fact changed.

Vout_mode (0x20): This is a 'read only' register. The upper three bits specify the supported data format, in this case Linear mode. The lower five bits specify the exponent of the data in two's complement binary format for output voltage related commands, such as Vout_command. These commands have a 16 bit mantissa. The exponent is fixed by the module and is returned by this command.

Mode	Bits [7:5]	Bits [4:0] (exponent)
Linear	000b	xxxxxb

Vout_Command (0x21) : This command is used to change the output voltage of the power supply.

Changing the output voltage should be performed simultaneously to all power supplies operating in parallel using the Global Address (Broadcast) feature. If only a single power supply is instructed to change its output, it may attempt to source all the required power which can cause either a power limit or shutdown condition.

Software programming of output voltage permanently overrides the set point voltage configured by the **Vprog** signal pin. The program no longer looks at the 'Vprog pin' and will not respond to any hardware voltage settings. If power is removed from the μ Controller it will reset itself into its default configuration looking at the **Vprog** signal for output voltage control. In many applications, the **Vprog** pin is used for setting initial conditions, if different than the factory setting. Software programming then takes over once I²C communications are established.

To properly hot-plug a power supply into a live backplane, the system generated voltage should get re-configured into either the factory adjusted firmware level or the voltage level reconfigured by the margin pin. Otherwise, the voltage state of the plugged in power supply could be significantly different than the powered system.

Voltage margin range: 10.8Vdc – 13.2 Vdc.

Fan_command_1 (0x3B): This command instructs the power supply to increase the speed of the fan. The transmitted data byte represents the hex equivalent of the duty cycle in percentage, i.e. 100% = 0x64h. The command can only increase fan speed, it cannot instruct the power supply to reduce the fan speed below what the power supply requires for internal control.

Sending 00h tells the power supply to revert back to its internal control.

Vout_OV_fault_limit (0x40): Sets the value at which the main output voltage will shut down. The default OV_fault value is set at 60Vdc. This level can be permanently changed and stored in non-volatile memory.

Vout_OV_warn_limit (0x42): **OV_warning** is extremely useful because it gives the system controller a heads up that the output voltage is drifting out of regulation and the power supply is close to shutting down. Pre-emptive action may be taken before the power supply would shut down and potentially disable the system. This level can be permanently changed and stored in non-volatile memory.

lout_OC_fault_limit (0x46): Sets the value at which the power supply will shut down. The default OC_fault_limit is 68Adc at high_line and 30A at low_line. (The value is contingent on whether the power supply operates in the low_line or high_line mode). This level can be permanently changed and stored in non-volatile memory. Which level is changed is contingent on the input voltage applied to the power supply at the time the change takes place.

lout_OC_fault_response (0x47): Sets the response if the output overload exceeds the OC_Fault_limit value. The default OC_fault_response is hiccup (0xF8). The only two allowable states are latched (0xC0) or hiccup. The default response state can be permanently changed and stored in non-volatile memory. The response is the same for both low_line and high_line operations.

lout_OC_warn_limit (0x4A): Sets the value at which the power supply issues a warning that the output current is getting too close to the shutdown level. The default OC_Warn_limit is set to 64.8A at high_line and 27.8A at low_line. This level can be permanently changed and stored in non-volatile memory. Which level is changed is contingent on the input voltage applied to the power supply at the time the change takes place.

OT_fault_limit (0x4F) : Sets the temperature value at which the power supply shuts down. The default OT_fault_limit is set at TBD°C. This level can be permanently changed and stored in non-volatile memory.

OT_fault_response (0x50): Sets the response if the output overtemperature exceeds the OT_Fault_limit value. The default OT_fault_response is hiccup (0xC0). The only two allowable states are latched (0x80) or hiccup. The default response state can be permanently changed and stored in non-volatile memory.

OT_warn_limit (0x51): Sets the value at which the power supply issues a warning that internal temperatures are getting too close to the shutdown level. The default OT_Warn_limit is set to TBD°C. This level can be permanently changed and stored in non-volatile memory.

CAR2012TE series rectifier

Input: 85Vac to 264Vac; Output: 12 Vdc @ 2000W; 3.3Vdc or 5 Vdc @ 4A

STATUS_BYTE (0x78) : Returns one byte of information with a summary of the most critical device faults.

Bit Position	Flag	Default Value
7	Busy	0
6	OFF	0
5	VOUT Overvoltage	0
4	IOUT Overcurrent	0
3	VIN Undervoltage	0
2	Temperature	0
1	CML (Comm. Memory Fault)	0
0	None of the above	0

STATUS_WORD (0x79) : Returns status_byte as the low byte and the following high_byte.

Bit Position	Flag	Default Value
7	VOUT fault or warning	0
6	IOUT fault or warning	0
5	INPUT	0
4	MFR SPECIFIC	0
3	nPOWER_GOOD	0
2	FANS	0
1	OTHER	0
0	UNKNOWN	0

STATUS_VOUT (0x7A) : Returns one byte of information of output voltage related faults.

Bit Position	Flag	Default Value
7	VOUT OV Fault	0
6	VOUT_OV_WARNING	0
5	VOUT_UV_WARNING	0
4	VOUT UV Fault	0
3 - 0	Not supported	0

STATUS_IOUT (0x7B) : Returns one byte of information of output current related faults.

Bit Position	Flag	Default Value
7	IOUT OC Fault	0
6	Not supported	0
5	IOUT OC Warning	0
4- 0	Not supported	0

STATUS_INPUT (0x7C) : Returns one byte of information of input voltage related faults.

Bit Position	Flag	Default Value
7	VIN_OV_Fault	0
6	VIN_OV_Warning	0
5	VIN_UV_Warning	0
4	VIN_UV_Fault	0
3 - 0	Not supported	0

STATUS_TEMPERATURE (0x7D) : Returns one byte of information of temperature related faults.

Bit Position	Flag	Default Value
7	OT Fault	0
6	OT Warning	0
5 - 0	Not supported	0

STATUS_CML (0x7E) : Returns one byte of information of communication related faults.

Bit Position	Flag	Default Value
7	Invalid/Unsupported Command	0
6	Invalid/Unsupported Data	0
5	Packet Error Check Failed	0
4 - 2	Not supported	0
1	Other Communication Fault	0
0	Not supported	0

STATUS_FAN_1_2 (0x81) : Returns one byte of information with a summary of the most critical device faults.

Bit Position	Flag	Default Value
7	Fan 1 Fault	0
6	Fan 2 Fault	0
5 - 4	Not supported	0
3	Fan 1 speed overwritten	0
2	Fan 2 speed overwritten	0
1 - 0	Not supported	0

Read back Descriptions

Single parameter read back: Functions can be read back one at a time using the read_word_protocol with PEC. A command is first sent out notifying the slave what function is to be read back followed by the data transfer.

Analog data is always transmitted LSB followed by MSB. A NA following the PEC byte signifies that the transmission is complete and is being terminated by the 'host'.

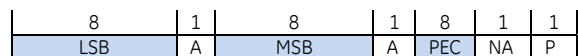
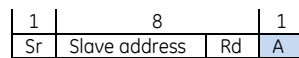
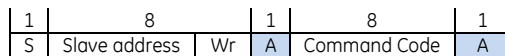

Read_fan_speed 1 & 2 (0x90, 0x91): Reading the fan speed is in Linear Mode returning the RPM value of the fan.

CAR2012TE series rectifier

Input: 85Vac to 264Vac; Output: 12 Vdc @ 2000W; 3.3Vdc or 5 Vdc @ 4A

Read_FRU_ID (0x99,0x9A, 0x9E): Returns FRU information

1	8	1	8	1
S	Slave address	Wr	A	Command 0x9x

1	8	1	8	1
Sr	Slave address	Rd	A	Byte count = x

8	1	8	1	8	1	8	1	1
high byte	A	Byte...	A	low byte	A	PEC	NA	P

Mfr_ID (0x99): Manufacturer in ASCII – 5 characters maximum,
 General Electric – Critical Power represented as: GE-CP

Mfr_MODEL (0x9A): Manufacturer model-number in ASCII – 16 characters, for this unit: CAR2012TEBXXZ01A

Mfr_serial (0x9E): Product serial number includes the manufacturing date, manufacturing location in up to 15 characters. For example:

13KZ51018193xxx, is decoded as;
 13 – year of manufacture, 2013
 KZ – manufacturing location, in this case Matamoros
 51 – week of manufacture

018193xxx – serial #, mfr choice
 note: if the additional xxx space is not utilized then F's are filled in, (i.e. 018193FFF), ensuring that the actual serial number is clearly identified.

Manufacturer-Specific PMBus™ Commands

Many of the manufacturer-specific commands read back more than two bytes. If more than two bytes of data are returned, the standard SMBus™ Block read is utilized. In this process, the Master issues a Write command followed by the data transfer from the power supply. The first byte of the Block Read data field sends back in hex format the number of data bytes, exclusive of the PEC number, that follows. Analog data is always transmitted LSB followed by MSB. A No-ack following the PEC byte signifies that the transmission is complete and is being terminated by the 'host'.

Mfr_Specific Status and alarm registers: The content and partitioning of these registers is significantly different than the standard register set in the PMBus™ specification. More information is provided by these registers and they are either accessed rapidly, at once, using the 'multi parameter' read back scheme of this document, or in batches of two STATUS and two ALARM registers.

Read_std_parameters (0xD0): This 'manufacturer specific' command is the basic read back returning STATUS and ALARM register data, output voltage, output current, and internal temperature data in a single read.

1	8	1	8	1
S	Slave address	Wr	A	Command Code

1	8	1	8	1
Sr	Slave address	Rd	A	Byte count = 10

8	1	8	1	8	1
Status-2	A	Status-1	A	Alarm-2	A

8	1	8	1	8	1
Alarm-1	A	Voltage LSB	A	Voltage MSB	A

8	1	8	1
Current-LSB	A	Current-MSB	A

8	1	8	1
Temperature-LSB	A	Temperature-MSB	A

8	1	1
PEC	NA	P

Read_Status_state (0xD1): This command returns the two STATUS register values using the standard 'read' format.

Status-2

Bit Position	Flag	Default Value
7	PEC Error	0
6	Will restart	0
5	Invalid_Instruction	0
4	Power_Capacity [HL = 1]	x
3	Isolation test failed	0
2	Restarted_OK	0
1	Data out_of_range	0
0	Remote ON [logic HI = 1]	x

Isolation test failed: The 'system controller' has to determine that sufficient capacity exists in the system to take a power supply 'off line' in order to test its isolation capability. Since the power supply cannot determine whether sufficient redundancy is available, the results of this test are provided, but the 'internal fault' flag is not set.

Status-1

Bit Position	Flag	Default Value
7	X	0
6	Isolation_Test_OK	0
5	Internal_Fault	0
4	Shutdown	0
3	Service LED ON	0
2	External_Fault	0
1	LEDs_Test_ON	0
0	Output ON	x

CAR2012TE series rectifier

Input: 85Vac to 264Vac; Output: 12 Vdc @ 2000W; 3.3Vdc or 5 Vdc @ 4A

Read_Alarm_state (0xD2): This command returns the two ALARM register values using the standard 'read' format.

Alarm-2

Bit Position	Flag	Default Value
7	FAN_Fault	0
6	No_Primary	0
5	Primary_OT	0
4	DC/DC_OT	0
3	Vo lower than BUS	0
2	Thermal sensor filed	0
1	Stby_out_of_limits	0
0	Power_Delivery	0

Power Delivery: The power supply compares its internal sourced current to the current requested by the current share pin. If the difference is > 10A, a fault is issued.

Alarm-1

Bit Position	Flag	Default Value
7	POWER LIMIT	0
6	PRIMARY Fault	0
5	OT_Shutdown	0
4	OT_Warning	0
3	IN OVERCURRENT	0
2	OV_Shutdown	0
1	VOUT_out_of_limits	0
0	VIN_out_of_limits	0

Over temperature warning: This flag is set approximately 5°C prior to the commencement of an over temperature shutdown.

Read_Fan_speed (0xD3) : Returns the commanded speed in percent and the measured speed in RPM. Up to 3 fans are supported. If a fan does not exist, or if the command is not supported the unit return 0x00.

1	8	1	8	1
S	Slave address	Wr	A	Command 0xE1

1	8	1	8	1
Sr	Slave address	Rd	A	Byte count = 4

8	1	8	1	8	1	8	1
Adjustment %	A	Fan-1	A	Fan-2	A	Fan-3	A

8	1	1
PEC	NA	P

Read_input_string (0xD4): Reads back the input voltage and input power consumed by the power supply.

1	7	1	1	8
S	Slave address	Wr	A	Command Code 0xDB

1	1	7	1	1	8	1
A	Sr	Slave Address	Rd	A	Byte Count = 5	A

8	1	8	1
Voltage - LSB	A	Voltage - MSB	A

8	1	8	1	8	1	1
Power - LSB	A	Power - MSB	A	PEC	No-ack	P

Read_mfr_rev (0xD5): A total of 4 bytes are returned. Each byte is partitioned into high and low nibbles.

Example: FF is read as 16.16
11 is read as 1.1

Series	Hardware Rev	Primary µC	Secondary µC

1	7	1	1	8	1
S	Slave address	Wr	A	Command Code 0xDD	A

1	1	7	1	1	8	1
A	Sr	Slave Address	Rd	A	Byte Count = 4	A

8	1	8	1	8	1
Series	A	Hardware rev	A	Primary µC	A

8	1	8	1	1
Secondary µC	A	PEC	No-ack	P

For example; the read returns one byte for each device (i.e. 0 x 10102114). The sequence is series, hardware rev, DSP, and I²C micro. 0x10 in the first byte indicates series 1.0. The second number indicates that the hardware rev is 1.0. The third number 21 for the DSP indicates revision 2.1, and the number 14 for the i2c micro indicates revision 1.4.

Read_run_timer (0xD6): This command reads back the recorded operational ON state of the power supply in hours. The operational ON state is accumulated from the time the power supply is initially programmed at the factory. The power supply is in the operational ON state both when in standby and when it delivers main output power.

Recorded capacity is approximately 10 years of operational state.

1	7	1	1	8	1
S	Slave address	Wr	A	Command Code 0xDC	A

1	7	1	1	8	1
Sr	Slave Address	Rd	A	Byte count = 4	A

8	1	8	1	8	1
Time - LSB	A	Time	A	Time - MSB	A

8	1	1
PEC	No-ack	P

CAR2012TE series rectifier

Input: 85Vac to 264Vac; Output: 12 Vdc @ 2000W; 3.3Vdc or 5 Vdc @ 4A

EEPROM record (0xD9): 64 bytes of EEPROM memory is available for customer records such as an additional FRU_ID. Block write is utilized since more than 2 data bytes are feasible. The first byte will be written into the pointed to memory location and each subsequent byte is incremented by a single memory location.

The standard protocol to access these records takes the form;

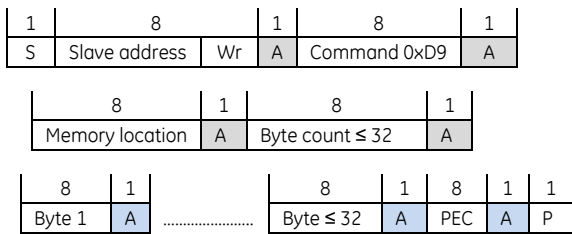

The highest memory location is address 0x64b.

Test Function (0xDF): This command can be used to exercise the LEDs of the power supply or the output Or'ing feature of the power supply.

Bit	Function	State
0	LED test	1:ON, 0:OFF
1	reserved	
2	reserved	
3	reserved	
4	Or'ing test	1:execute, 0:idle
5	reserved	
6	reserved	
7	reserved	

Setting bit 0 of the data byte to 1 instructs the power supply to execute an LED test. During this test both LEDs are turned ON and OFF every 0.5 second. The tri-state LED should be exercised sequentially in its green, orange, and red state. The test should continue until bit 0 of the data byte is set to 0 in a subsequent instruction.

Setting bit 5 of the data byte to 1 instructs the power supply to execute once an output Or'ing test in applications where multiple paralleled power supplies are utilized. The host should verify that N+1 redundancy is established. If N+1 redundancy is not established the test can fail. Only one power supply should be tested at a time.

Verifying test completion should be delayed for approximately 30 seconds to allow the power supply sufficient time to properly execute the test.

During the test the power supply will lower its output voltage and measure the difference between the internal and external sides of the Or'ing function. This measurement will determine whether the Or'ing function is working properly.

The system controller must conclude that sufficient power capacity exists to deliver output power to the system while this unit is purposely taken off the bus by lowering its output voltage. Since validity of the test is system control dependent, the power supply does not conclude whether it is properly

functioning. The system controller must determine whether the function is working properly.

Valid data bytes are: 0x00, 0x01, 0x10, 0x11

Fault management

The power supply recognizes that certain transitional states can occur before a final state is reached. The STATUS and ALARM registers will not be frozen into a notification state until the final state is reached. Once a final state is reached the SMBAlert# signal is set and the STATUS and ALARM registers will not get reinstated until a clear_faults is issued by the master. The only exception is that additional state changes may be added to the original list if further changes are noted.

The power supply differentiates between **internal faults** that are within the power supply and **external faults** that the power supply protects itself from, such as overload or input voltage out of limits. The FAULT LED, FAULT PIN or i2c alarm is not asserted for EXTERNAL FAULTS. Every attempt is made to annunciate External Faults. Some of these annunciations can be observed by looking at the input LEDs. These fault categorizations are predictive in nature and therefore there is a likelihood that a categorization may not have been made correctly.

Input voltage out of range: The Input LED will continue blinking as long as sufficient power is available to power the LED. If the input voltage is completely gone the Input LED is OFF.

State change definition

A **state_change** is an indication that an event has occurred that the MASTER should be aware of. The following events shall trigger a **state_change**;

- Initial power-up of the system when AC gets turned ON . This is the indication from the power supply that it has been turned ON.
- Whenever the power supply gets hot-plugged into a working system. This is the indicator to the system (MASTER) that a new power supply is on line.
- Any changes in the bit patterns of the STATUS and ALARM registers are a STATUS change which triggers the SMBALERT# flag.

Note that a host-issued command such as turning the output OFF will not trigger an SMBAlert# even though the STATUS registers will change to indicate the latest state of the power supply.

Hot plug procedures

Careful system control is recommended when hot plugging a power supply into a live system. It takes about 15 seconds for a power supply to configure its address on the bus based on the analog voltage levels present on the backplane. If communications are not stopped during this interval, multiple power supplies may respond to specific instructions because the address of the hot plugged power supply always defaults

CAR2012TE series rectifier

Input: 85Vac to 264Vac; Output: 12 Vdc @ 2000W; 3.3Vdc or 5 Vdc @ 4A

to xxxx000 (depending on which device is being addressed within the power supply) until the power supply configures its address.

The recommended procedure for hot plug is the following: The system controller should poll the module_present signal to verify when a power supply is inserted into the system. When a new module is detected the system controller should cease any communications with the power system for 15 seconds. At the end of the time out all communications can resume. Note that although hot-plug should not affect ongoing communications, if a discrepancy should arise the error should get picked up by the PEC calculation. Ofcourse the system controller could always use the module_present signal as an indicator to ignore communications that are currently taking place.

Failure predictions

Alarm warnings that do not cause a shutdown are indicators of potential future failures of the power supply. For example, if a thermal sensor failed, a warning is issued but an immediate shutdown of the power supply is not warranted.

Another example of potential predictive failure mechanisms can be derived from information such as fan speed when multiple fans are used in the same power supply. If the speed of the fans varies by more than 20% from each other, this is an indication of an impending fan wear out.

The goal is to identify problems early before a protective shutdown would occur that would take the power supply out of service.

Information only alarms: The following alarms are for information only, they do not cause a shutdown

- Over temperature warning
- V_{out} out-of-limits (above 36Vdc)
- Output voltage lower than bus
- Unit in Power Limit
- Thermal sensor failed
- Or'ing (Isolation) test failure
- Power delivery
- Stby out of limits
- Communication errors

LEDs

Two LEDs are located on the front faceplate. The AC_OK LED provides visual indication of the INPUT signal function. When the LED is ON GREEN the power supply input is within normal design limits.

The second LED DC/FLT is a dual-state LED. When GREEN there are no faults and DC output is present. When 'blinking' a fault condition exists but the power supply may still provide some output power. When RED, a fault condition exists and the power supply has been shut down, it does not provide any output power.

Alarm Table

Test Condition		LED Indicator		Monitoring Signals			
		LED1 INPUT OK	Tri-Color LED2 Temp OK/DC OK / Fault	FAULT	DC OK	INPUT OK	TEMP OK
1	Normal Operation	Green	Green	High	High	High	High
2	Out of range INPUT	Blinking	?	High	?	Pulsing	High
3	No Input	OFF	OFF	High	Low	Low	High
4	OVP	Green	Red	Low	Low	High	High
5	Over Current	Green	Blinking	High	Low	High	High
6	Over Temp Warning	Green	Blinking Orange	High	High	High	Pulsing
7	Over Temp Fault	Green	Red	Low	Low	High	Low
8	Remote ON	Green	Green	High	High	High	High
9	Remote OFF	Green	OFF	High	Low	High	High

Notes: Test condition #2 and #3 had 2 modules plug in. One module is running and the other one is with no/low AC.

Test condition #5, The DC_OK signal responds to two independent conditions. It can activate either for loss of output because of an overload condition, or it can activate because of the impending loss of output voltage because input power has been interrupted. In case of an overload condition, depending on how deep is the overload, sufficient holdup may not be present to provide the required delay prior to the regulation going below 10.8 V_{DC}.

Blinking of the overload LED will not occur until the output voltage decayed about 0.3V from its regulation point. During hiccup, blinking occurs only during the ON-time state.

? – module output could be either ON or OFF dependent on output loading and internal capability.

Blinking frequency: 0.5 seconds ON, 0.5 seconds OFF.

CAR2012TE series rectifier

Input: 85Vac to 264Vac; Output: 12 Vdc @ 2000W; 3.3Vdc or 5 Vdc @ 4A

Outline Drawing

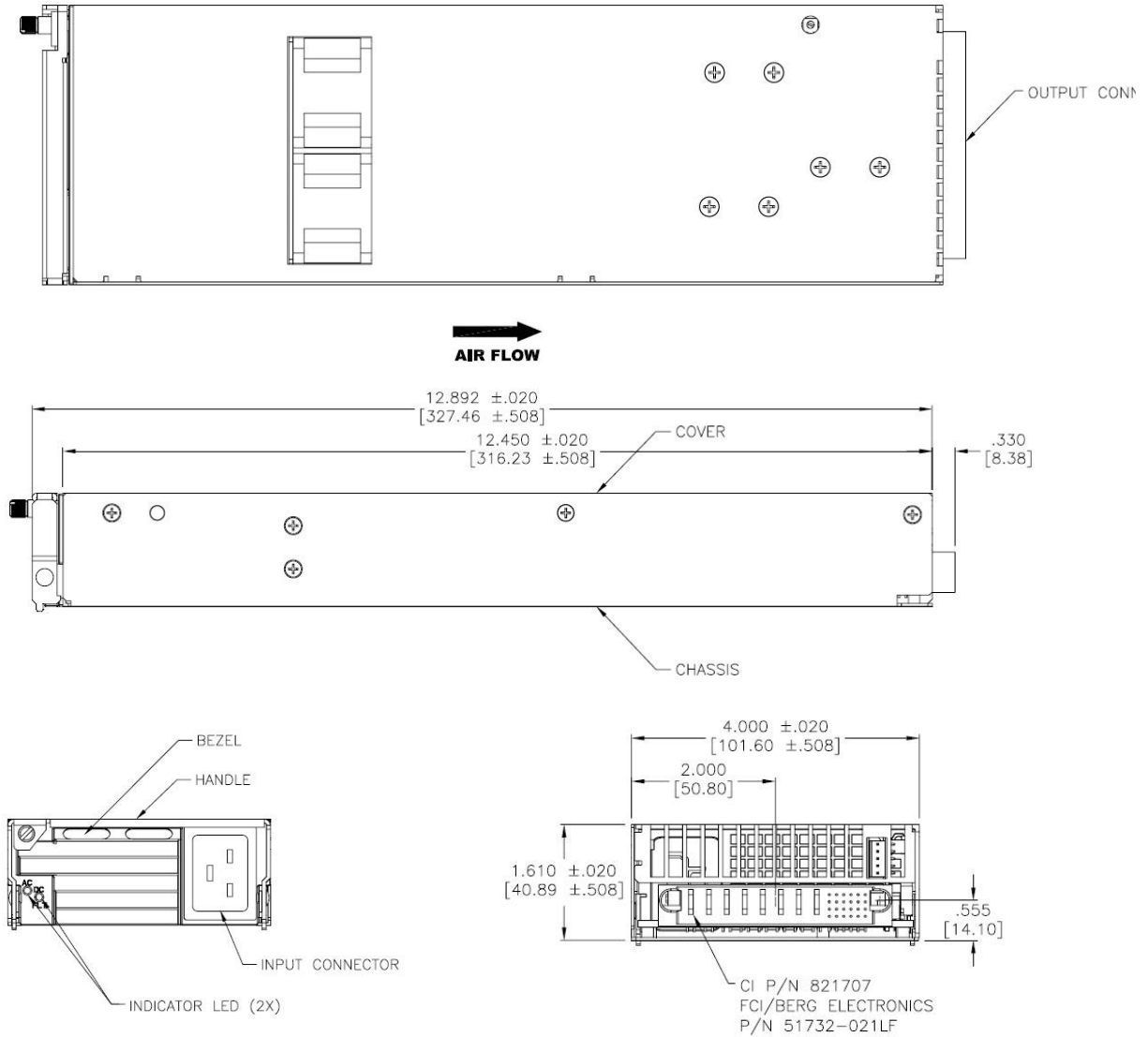

CAR2012TE series rectifier

Input: 85Vac to 264Vac; Output: 12 Vdc @ 2000W; 3.3Vdc or 5 Vdc @ 4A

Connector Pin Assignments

Input Connector: IEC320, C20;
mating connector: IEC320, C19 type

Output Connector: FCI Berg⁷ P/N 10106124-8006005LF
TE 3-6450832-9

Mating connector: FCI Berg P/N 10106126-8006002LF right angle receptacle
TE 1-6450872-5 right angle receptacle
FCI Berg P/N 10106130-8006001LF straight receptacle

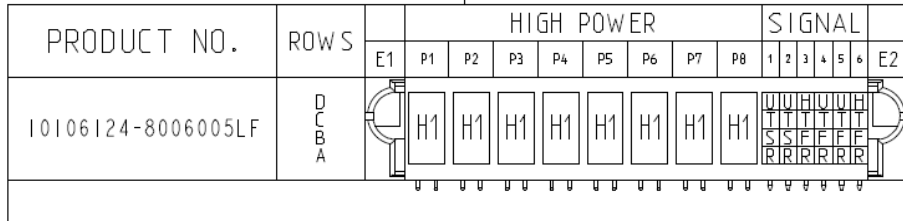

Short signal pins: F, H
Long signal pins: R,S,T,U

Pin	Function	Pin	Function	Pin	Function	Pin	Function
A1	Vstb	B1	Fault	C1	IShare	D1	VProg
A2	Vstb [3.3V] Return	B2	I Monitor (IMON)	C2	N/A	D2	OVP Test Point
A3	Vstb Return	B3	Interlock	C3	Over Temp Warning	D3	Remote ON/OFF
A4	N/A	B4	PS Present	C4	I ² C Address (A0)	D4	DC OK
A5	Remote Sense (+)	B5	SDA (I ² C bus)	C5	I ² C Address (A1)	D5	AC OK
A6	Remote Sense (-)	B6	SCL (I ² C bus)	C6	I ² C Address (A2)	D6	SMBAlert
P1 – P4						Output Return	
						P5– P8	
						+12Vout	

Short signal pin
 Short signal pin will be introduced when connector is available

⁷ Only the listed FCI BERG connectors are recommended. Other manufacturers should not be used

