



Chipsmall Limited consists of a professional team with an average of over 10 year of expertise in the distribution of electronic components. Based in Hongkong, we have already established firm and mutual-benefit business relationships with customers from,Europe,America and south Asia,supplying obsolete and hard-to-find components to meet their specific needs.

With the principle of “Quality Parts,Customers Priority,Honest Operation,and Considerate Service”,our business mainly focus on the distribution of electronic components. Line cards we deal with include Microchip,ALPS,ROHM,Xilinx,Pulse,ON,Everlight and Freescale. Main products comprise IC,Modules,Potentiometer,IC Socket,Relay,Connector.Our parts cover such applications as commercial,industrial, and automotives areas.

We are looking forward to setting up business relationship with you and hope to provide you with the best service and solution. Let us make a better world for our industry!



## Contact us

Tel: +86-755-8981 8866 Fax: +86-755-8427 6832

Email & Skype: info@chipsmall.com Web: www.chipsmall.com

Address: A1208, Overseas Decoration Building, #122 Zhenhua RD., Futian, Shenzhen, China





# 5 V and 3.3 V Supply Monitor, Watchdog Timer, Manual Reset, with Active High & Low Resets



## FEATURES

- Selectable reset voltage tolerance
  - CAT1232LP for 5 V supply
  - CAT1832 for 3.3 V supply
- Selectable watchdog period: 150 ms, 600 ms or 1.2 s
- Two reset outputs
  - Active high, push-pull reset output
  - Active low, open-drain reset output (CAT1232LP)
  - Active low, push-pull reset output (CAT1832)
- Debounced manual push-button reset
- Compact SOIC and MSOP packages

For Ordering Information details, see page 11.

## APPLICATIONS

- Microprocessor Systems
- Portable Equipment
- Controllers
- Single Board Computers
- Instrumentations
- Telecommunications

## DESCRIPTION

The CAT1232LP and CAT1832 microprocessor supervisors can halt and restart a “hung-up” or “stalled” microprocessor, restart a microprocessor after a power failure, and debounce a manual/push-button microprocessor reset switch. The devices are drop in replacements for the Maxim/Dallas Semiconductor DS1232LP and DS1832 supervisors

Precision reference and comparator circuits monitor the 5 V or 3.3 V system power supply voltage,  $V_{CC}$ . During power-up or when the power supply falls outside selectable tolerance limits, both the RESET and  $\overline{\text{RESET}}$  become active. After the power supply voltage rises above the RESET threshold voltage, the reset signals remain active for a minimum of 250ms, allowing the power supply and system processor to stabilize. The trip-point tolerance input, TOL, selects the trip level tolerance to be either 5% or 10% for the CAT1232LP 5 V supply and 10% or 20% for the CAT1832 3.3 V supply.

Each device has a push-pull, active HIGH reset output. The CAT1232LP also has an open drain, active LOW reset output while the CAT1832 also has a push-pull, active LOW reset output.

A debounced manual reset input activates the reset outputs and holds them active for a minimum period of 250 ms after being released.

Also included is a watchdog timer to reset a microprocessor that has stopped due to a software or hardware failure. Three watchdog time-out periods are selectable: 150 ms, 600 ms and 1.2 s. If the  $\overline{\text{ST}}$  input is not strobed low before the watchdog time out period expires, the reset signals become active for a minimum of 250 ms.

## FUNCTIONAL DIAGRAM

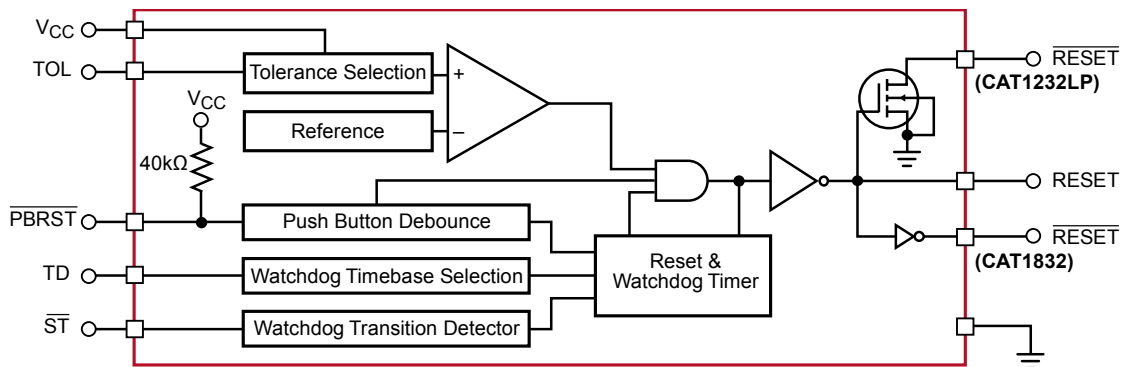

**PIN CONFIGURATION**

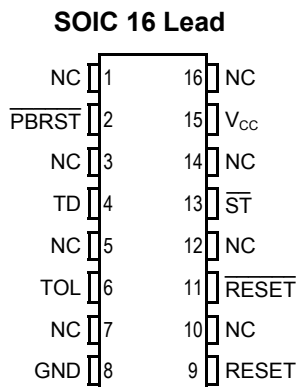
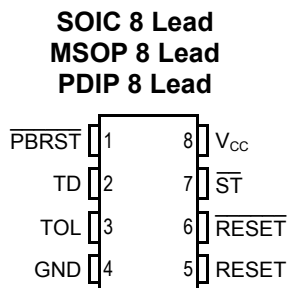

**PIN DESCRIPTION**

Pin Number 8-Lead Package	Pin Number 16-Lead Package	Name	Function
1	2	$\overline{\text{PBRST}}$	Debounced manual pushbutton reset input
2	4	TD	Watchdog typical time delay selection: a) $t_{\text{TD}} = 150 \text{ ms}$ for TD = GND b) $t_{\text{TD}} = 600 \text{ ms}$ for TD = Open c) $t_{\text{TD}} = 1200 \text{ ms}$ for TD = $V_{\text{CC}}$
3	6	TOL	CAT1232LP TOL selects 5% (TOL = GND) or 10% (TOL = $V_{\text{CC}}$ ) trip point tolerance. CAT1832 TOL selects 10% (TOL = GND) or 20% (TOL = $V_{\text{CC}}$ ) trip point tolerance.
4	8	GND	Ground
5	9	RESET	Active HIGH reset output. RESET is active 1. If $V_{\text{CC}}$ falls below the reset voltage trip point 2. If $\overline{\text{PBRST}}$ is low 3. If $\overline{\text{ST}}$ is not strobed low before the timeout period set by TD expires. 4. During power-up.
6	11	RESET	Active LOW reset output. (See RESET)
7	13	$\overline{\text{ST}}$	Strobe Input
8	15	$V_{\text{CC}}$	Power Supply
	1, 3, 5, 7, 10, 12, 14, 16	NC	No internal connection

**ABSOLUTE MAXIMUM RATINGS (\*)**

Parameters	Ratings	Units
Voltage on $V_{\text{CC}}$	-0.5 to 7.0	V
Voltage on $\overline{\text{ST}}$ and TD	-0.5 to $V_{\text{CC}} + 0.5$	V
Voltage on $\overline{\text{PBRST}}$ , $\overline{\text{RESET}}$ and RESET	-0.5 to $V_{\text{CC}} + 0.5$	V

Parameters	Ratings	Units
Maximum Junction Temperature	125	$^{\circ}\text{C}$
Storage Temperature Range	-65 to +150	$^{\circ}\text{C}$
Lead Soldering Temperature (10s)	300	$^{\circ}\text{C}$
Operating Temperature Range	-40 to +85	$^{\circ}\text{C}$

**Note:**

\* Stresses above those listed under "Absolute Maximum Ratings" may cause permanent damage to the device. These are stress ratings only, and functional operation of the device at these or any other conditions outside of those listed in the operational sections of this specification is not implied. Exposure to any absolute maximum rating for extended periods may affect device performance and reliability.



## CAT1232LP, CAT1832

### ELECTRICAL CHARACTERISTICS

Unless otherwise stated, 1.0 V -  $V_{CC}$  - 5.5 V and over the operating temperature range of -40°C to +85°C.

All voltages are referenced to ground.

Symbol	Parameter	Conditions	Min	Typ	Max	Units
$V_{CC}$	Supply Voltage		1.0		5.5	V
$I_{CC1}$	Supply Current	$V_{CC} = 5.5$ V, CAT1232LP		35	50	$\mu$ A
		$V_{CC} = 3.6$ V, CAT1832		20	35	
$V_{IH}$	ST and $\overline{PBRST}$ Input High Level	(5)	2		$V_{CC} + 0.3$ V	V
		(6)	$V_{CC} - 0.4$ V			
$V_{IL}$	ST and $\overline{PBRST}$ Input Low Level	$V_{CC} = 5.5$ V, CAT1232LP	-0.3		0.8	V
		$V_{CC} = 3.6$ V, CAT1832			0.5	
$V_{CCTP}$	$V_{CC}$ Trip Point (TOL = GND)	CAT1232LP	4.50	4.62	4.74	V
$V_{CCTP}$	$V_{CC}$ Trip Point (TOL = $V_{CC}$ )	CAT1232LP	4.25	4.37	4.49	V
$V_{CCTP}$	$V_{CC}$ Trip Point (TOL = GND)	CAT1832	2.80	2.88	2.97	V
$V_{CCTP}$	$V_{CC}$ Trip Point (TOL = $V_{CC}$ )	CAT1832	2.47	2.55	2.64	V
$t_{TD}$	Watchdog Time-Out Period	TD = GND	62.5	150	250	ms
$t_{TD}$	Watchdog Time-Out Period	TD = $V_{CC}$	500	1200	2000	ms
$t_{TD}$	Watchdog Time-Out Period	TD floating	250	600	1000	ms
$V_{OH}$	Output Voltage	$I = -500$ $\mu$ A <sup>(3)</sup>	$V_{CC} - 0.5$ V	$V_{CC} - 0.1$ V		V
$I_{OH}$	Output Current	Output = 2.4 V <sup>(2)</sup>		-350		$\mu$ A
$I_{OL}$	Output Current	Output = 0.4 V	10			mA
$I_{IL}$	Input Leakage	(1)	-1.0		1.0	$\mu$ A
$R_{PU}$	Internal Pull-Up Resistor	(1)	32	40	55	k $\Omega$
$C_{IN}$	Input Capacitance				5	pF
$C_{OUT}$	Output Capacitance				7	pF
$t_{PB}$	$\overline{PBRST}$ Manual Reset Minimum Low Time	$\overline{PBRST} = V_{IL}$	20			ms
$t_{RST}$	Reset Active Time		250	600	1000	ms
$t_{ST}$	$\overline{ST}$ Pulse Width	(4)	20			ns
$t_{RPD}$	$V_{CC}$ Fail Detect to RESET or $\overline{RESET}$			5	8	$\mu$ s
$t_F$	$V_{CC}$ Slew Rate		20			$\mu$ s
$t_{PDLY}$	$\overline{PBRST}$ Stable LOW to RESET and $\overline{RESET}$ Active				20	ms
$t_{RPU}$	$V_{CC}$ Detect to RESET or $\overline{RESET}$ Inactive	$t_{RISE} = 5$ $\mu$ s	250	600	1000	ms
$t_R$	$V_{CC}$ Slew Rate	4.25 V to 4.75 V	0			ns

#### Notes:

- (1)  $\overline{PBRST}$  is internally pulled HIGH to  $V_{CC}$  through a nominal 40 k $\Omega$  resistor (RPU).
- (2)  $\overline{RESET}$  is an open drain output on the CAT1232LP.
- (3) RESET remains within 0.5 V of  $V_{CC}$  on power-down until  $V_{CC}$  falls below 2 V. RESET remains within 0.5 V of ground on power-down until  $V_{CC}$  falls below 2.0 V.
- (4) Must not exceed the minimum watchdog time-out period ( $t_{TD}$ ). The watchdog circuit cannot be disabled. To avoid a reset,  $\overline{ST}$  must be strobed.
- (5) Measured with  $V_{CC} \geq 2.7$  V.
- (6) Measured with  $V_{CC} < 2.7$  V.

**TYPICAL CHARACTERISTICS**

For the CAT1232LP,  $V_{CC} = 5\text{ V}$  and  $T_{AMB} = 25^\circ\text{C}$  unless otherwise stated.

**Threshold Voltage vs. Temperature (10% TOL)**

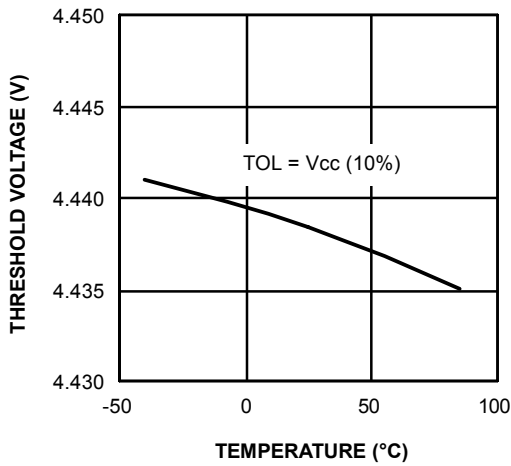

**Threshold Voltage vs. Temperature (5% TOL)**

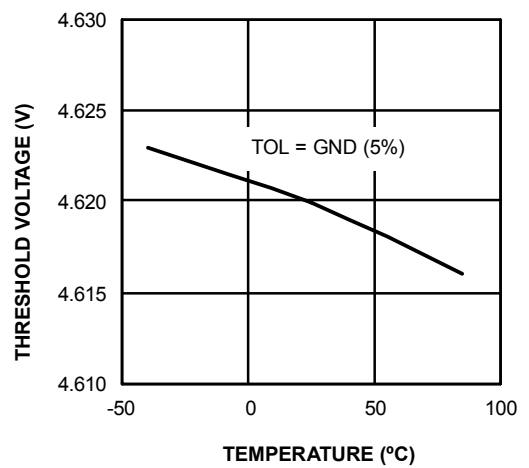

**Supply Current vs. Temperature**

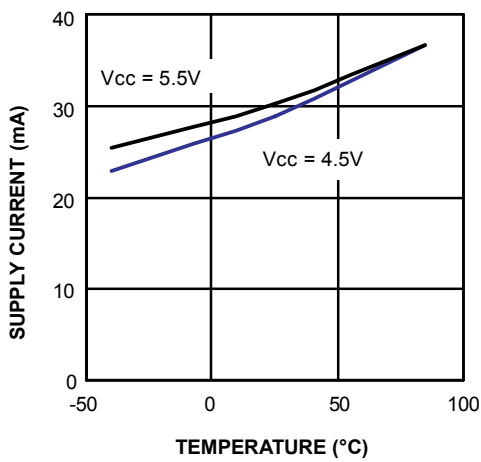

**Reset Active Time vs. Temperature**

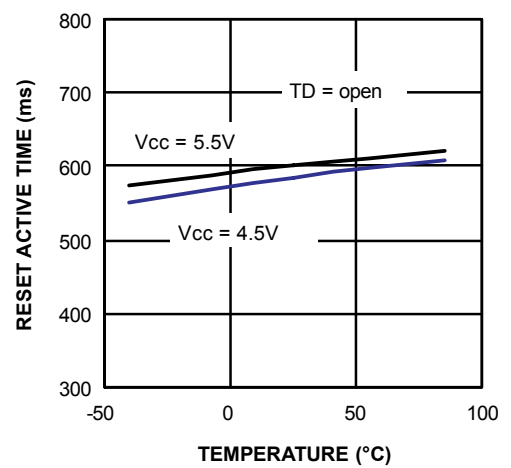

**Reset Active Time Waveform**

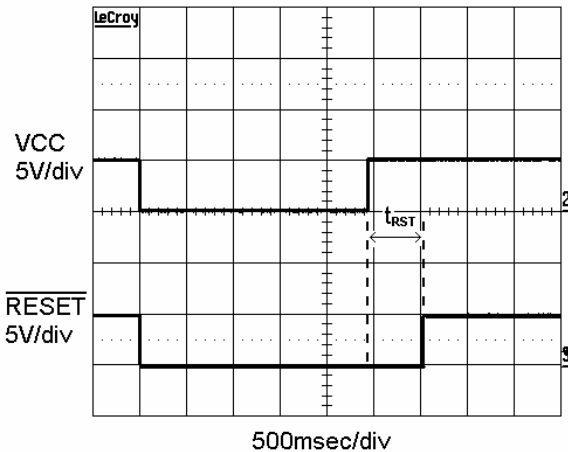

**Transient Response**

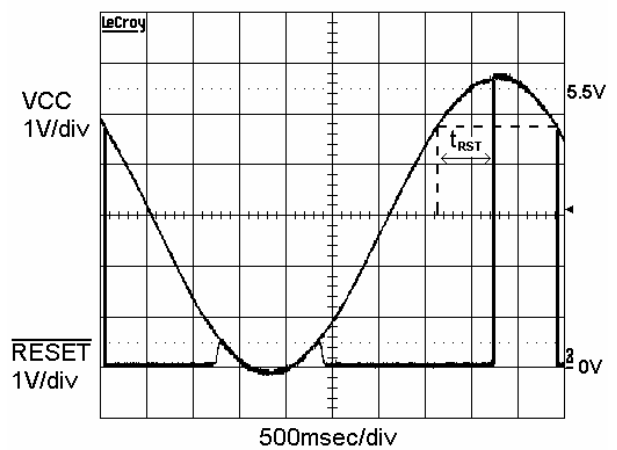

**APPLICATION INFORMATION**

**SUPPLY VOLTAGE MONITOR**

**Reset Signal Polarity and Output Stage Structure**

$\overline{\text{RESET}}$  is an active LOW signal. It is developed with an open drain driver in the CAT1232LP. A pull-up resistor is required, typical values are 10 k $\Omega$  to 50 k $\Omega$ . The CAT1832 uses a CMOS push-pull output stage for the  $\overline{\text{RESET}}$ .

RESET is an active High signal developed by a CMOS push-pull output stage and is the logical opposite to  $\overline{\text{RESET}}$ .

**Trip Point Tolerance Selection**

The TOL input is used to select the  $V_{CC}$  trip point threshold. This selection is made connecting the TOL input to ground or  $V_{CC}$ . Connecting TOL to Ground makes the  $V_{CC}$  trip threshold 4.62 V for the CAT1232LP and 2.88 V for the CAT1832.

Connecting TOL to  $V_{CC}$  makes the  $V_{CC}$  trip threshold 4.37 V for the CAT1232LP and 2.55 V for the CAT1832.

After  $V_{CC}$  has risen above the trip point set by TOL, RESET and  $\overline{\text{RESET}}$  remain active for a minimum time period of 250 ms.

On power-down, once  $V_{CC}$  falls below the reset threshold the RESET outputs will remain active and are guaranteed valid down to a  $V_{CC}$  level of 1.0 V.

Tolerance Select Voltage	Trip Point Tolerance	Trip Point Voltage (V)		
		Min	Nominal	Max
CAT1232LP TOL = $V_{CC}$	10 %	4.25	4.37	4.49
CAT1232LP TOL = GND	5 %	4.50	4.62	4.74
CAT1832 TOL = $V_{CC}$	20 %	2.47	2.55	2.64
CAT1832 TOL = GND	10 %	2.80	2.88	2.97

**Manual Reset Operation**

Push-button input,  $\overline{\text{PBRST}}$ , allows the user to issue reset signals. The pushbutton input is debounced and is pulled high through an internal 40 k $\Omega$  resistor.

When  $\overline{\text{PBRST}}$  is held low for the minimum time of 20 ms, both resets become active and remain active for a minimum time period of 250 ms after PBRST returns high.

No external pull-up resistor is required, since  $\overline{\text{PBRST}}$  is pulled high by an internal 40 k $\Omega$  resistor.

$\overline{\text{PBRST}}$  can be driven from a TTL or CMOS logic line or short-ed to ground with a mechanical switch.

**Figure 1. Timing Diagram: Power Up**

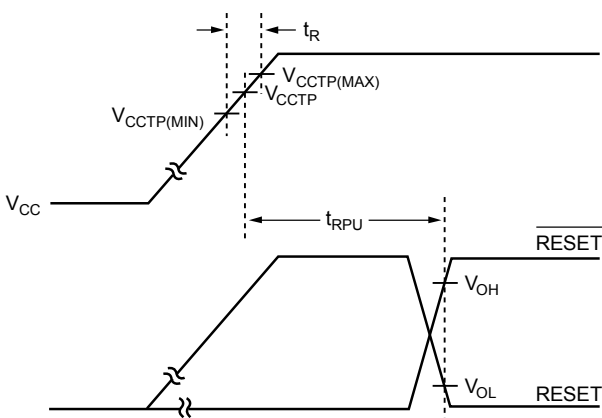

**Figure 2. Timing Diagram: Power Down**

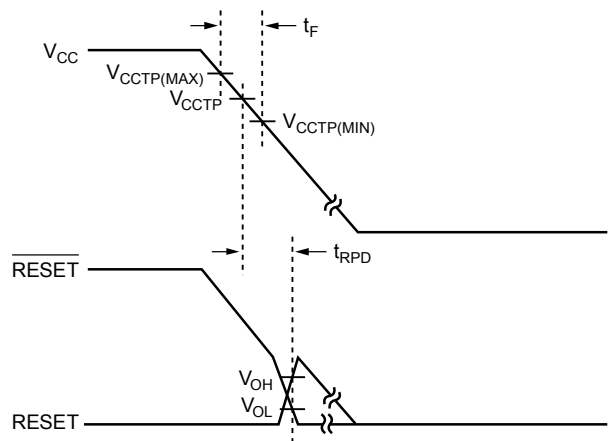

**WATCHDOG TIMER AND  $\overline{ST}$  INPUT**

A watchdog timer stops and restarts a microprocessor that has stopped proper operation or become “hung”. The watchdog performs this function by monitoring the  $\overline{ST}$  input. After the reset outputs go inactive the  $\overline{ST}$  input must be strobed with a high-to-low signal transition prior to the minimum watchdog timeout period. However if the  $\overline{ST}$  input is not strobed with a high-to-low signal transition prior to a watchdog timeout the reset outputs will become active for TRST resetting and restarting the microprocessor. Once the resets return to the inactive state the watchdog timer restarts the process.

The TD input allows the user to select from three predetermined watchdog timeout periods. Always use the minimum timeout period to determine the required frequency of  $\overline{ST}$  high-to-low transitions and the maximum to determine the time prior to the reset outputs becoming active.  $\overline{ST}$  pulse widths must be 20 ns or greater.

The watchdog timer cannot be disabled. It must be strobed with a high-to-low signal transition to avoid a watchdog timeout and subsequent reset.

TD Voltage Level	Watchdog Time-out Period (ms)		
	Min	Nominal	Max
GND	62.5	150	250
Floating	250	600	1000
V <sub>CC</sub>	500	1200	2000

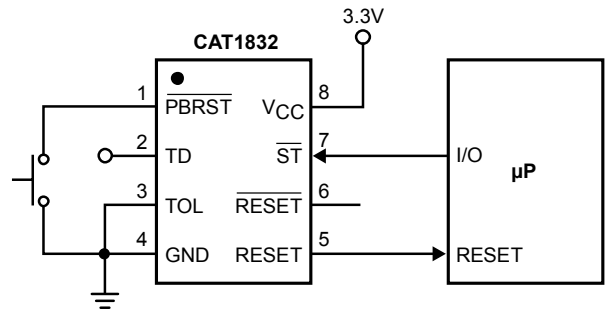

**Figure 4. CAT1832 Application Circuit: Pushbutton Reset**

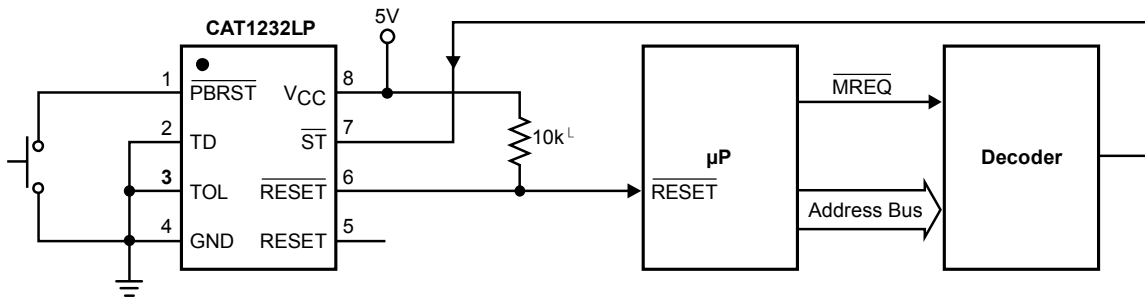

**Figure 5. CAT1232LP Application Circuit: Watchdog Timer**

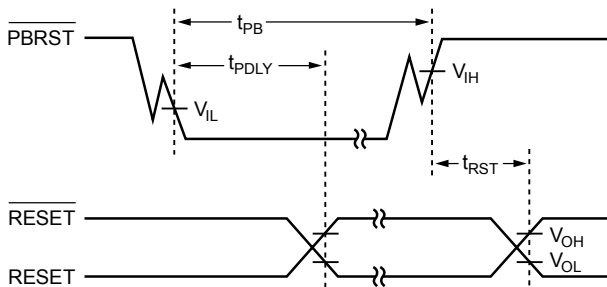

**Figure 6. Timing Diagram: Pushbutton Reset**

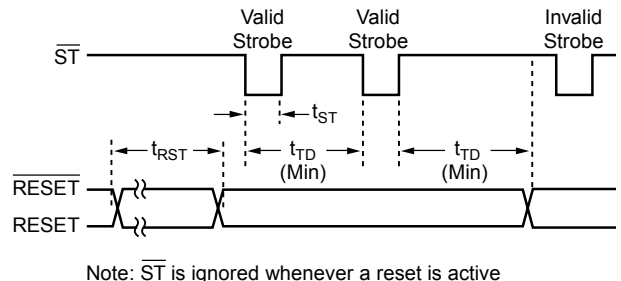

**Figure 7. Timing Diagram: Strobe Input**

PACKAGE OUTLINE DRAWINGS

SOIC 16-Lead 300 mils (W)<sup>(1)(2)</sup>

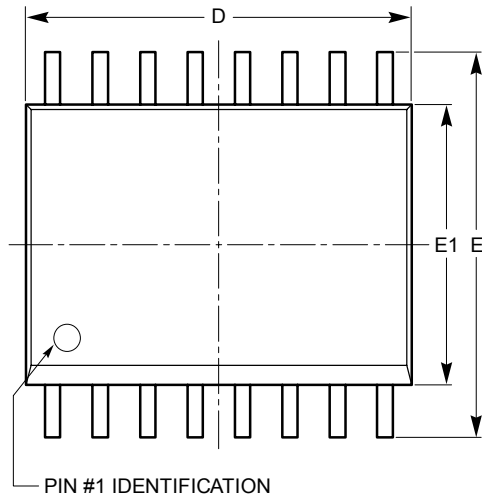

TOP VIEW

SYMBOL	MIN	NOM	MAX
A	2.36	2.49	2.64
A1	0.10		0.30
b	0.33	0.41	0.51
c	0.18	0.23	0.28
D	10.08	10.31	10.49
E	10.01	10.31	10.64
E1	7.39	7.49	7.59
e	1.27 BSC		
h	0.25		0.75
L	0.38	0.81	1.27
$\theta$	0°		8°

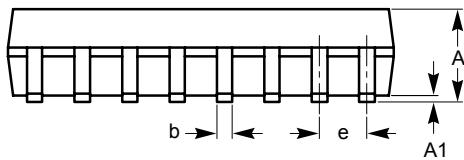

SIDE VIEW

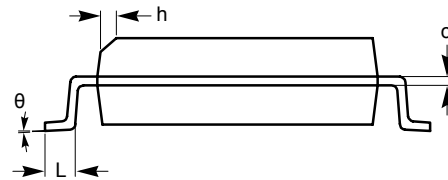

END VIEW

Notes:

- (1) All dimensions are in millimeters.
- (2) Complies with JEDEC MS-013.



# CAT1232LP, CAT1832

## PDIP 8-Lead 300mils (L)<sup>(1)(2)</sup>

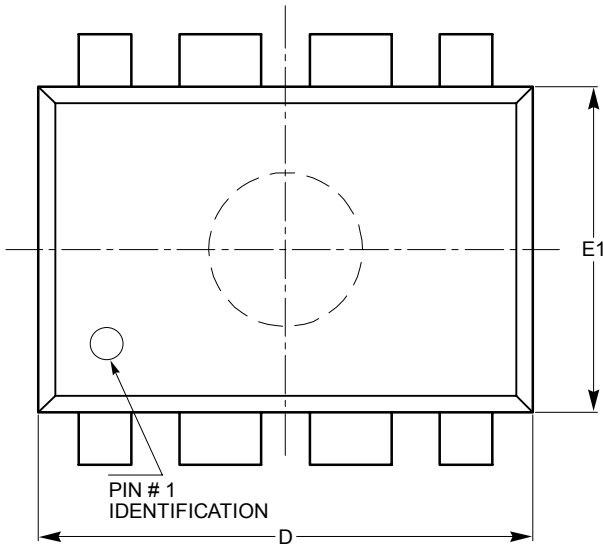

TOP VIEW

SYMBOL	MIN	NOM	MAX
A			5.33
A1	0.38		
A2	2.92	3.30	4.95
b	0.36	0.46	0.56
b2	1.14	1.52	1.78
c	0.20	0.25	0.36
D	9.02	9.27	10.16
E	7.62	7.87	8.25
e	2.54 BSC		
E1	6.10	6.35	7.11
eB	7.87		10.92
L	2.92	3.30	3.80

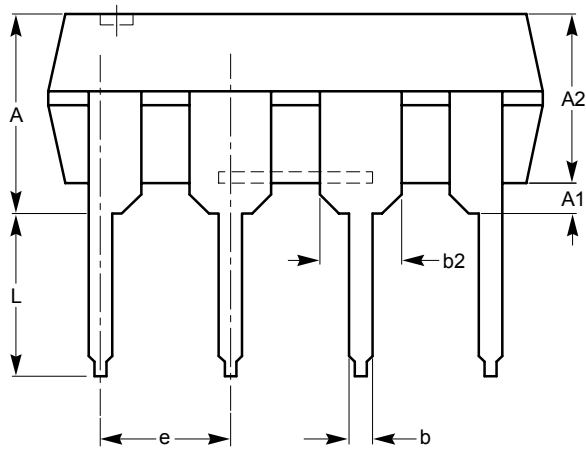

SIDE VIEW

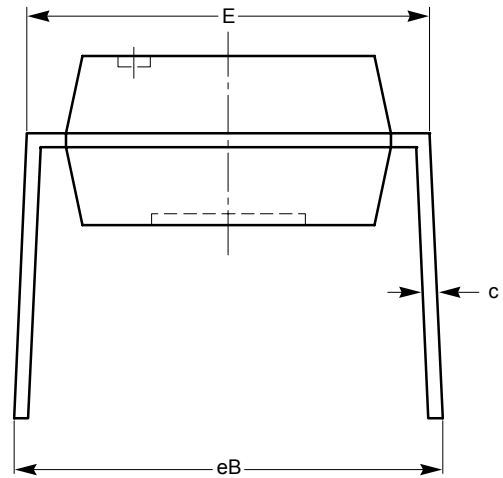

END VIEW

**Notes:**

- (1) All dimensions are in millimeters.
- (2) Complies with JEDEC MS-001.

# CAT1232LP, CAT1832

## MSOP 8-Lead (Z) <sup>(1)(2)</sup>

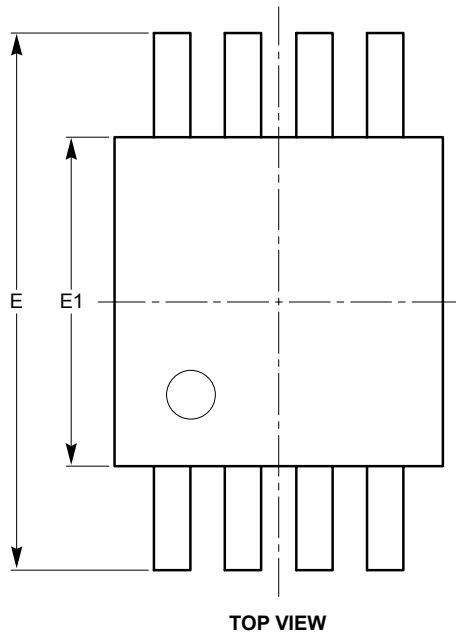

SYMBOL	MIN	NOM	MAX
A			1.10
A1	0.05	0.10	0.15
A2	0.75	0.85	0.95
b	0.22		0.38
c	0.13		0.23
D	2.90	3.00	3.10
E	4.80	4.90	5.00
E1	2.90	3.00	3.10
e	0.65 BSC		
L	0.40	0.60	0.80
L1	0.95 REF		
L2	0.25 BSC		
$\theta$	0°		6°

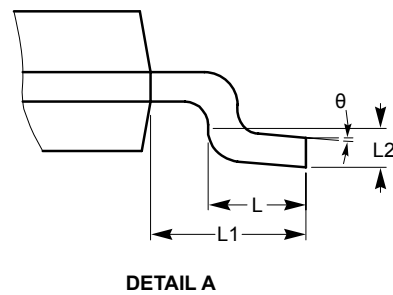
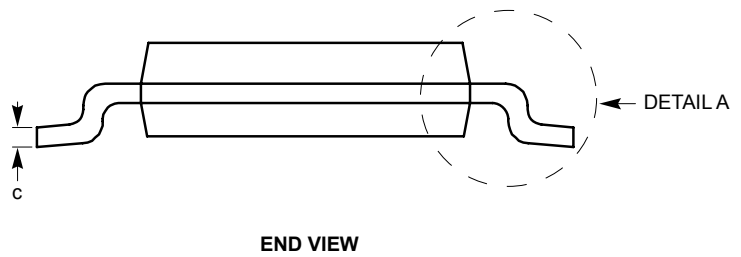
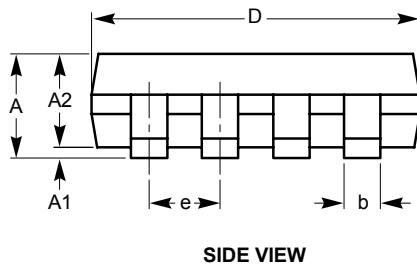

**Notes:**

- (1) All dimensions are in millimeters. Angles in degrees.
- (2) Complies with JEDEC MO-187.

# CAT1232LP, CAT1832

## SOIC 8-Lead 150mils (V) <sup>(1)(2)</sup>

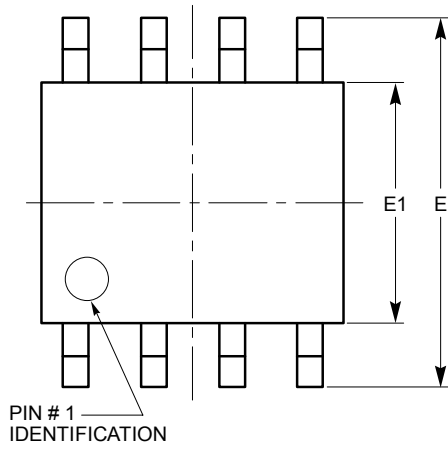

TOP VIEW

SYMBOL	MIN	NOM	MAX
A	1.35		1.75
A1	0.10		0.25
b	0.33		0.51
c	0.19		0.25
D	4.80		5.00
E	5.80		6.20
E1	3.80		4.00
e	1.27 BSC		
h	0.25		0.50
L	0.40		1.27
$\theta$	0°		8°

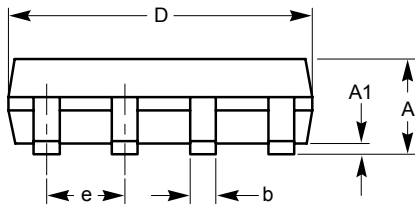

SIDE VIEW

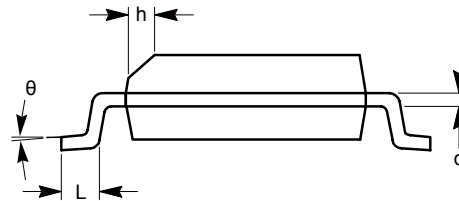

END VIEW

**Notes:**

- (1) All dimensions are in millimeters. Angles in degrees.
- (2) Complies with JEDEC MS-012.

# CAT1232LP, CAT1832

## ORDERING INFORMATION

ORDERING PART NUMBER	Package	Parts per Tube	Parts Per Reel	Reel Size (inch)
CAT1232LPV-GT3*	8-lead, SOIC	—	3,000	13
CAT1232LPZ-GT3*	8-lead, MSOP	—	3,000	13
CAT1832L-G	8-lead, PDIP	50	—	—
CAT1832V-GT3	8-lead, SOIC	—	3,000	13
CAT1832Z-GT3	8-lead, MSOP	—	3,000	13

\* Consult sales.

### Notes:

- (1) All packages are RoHS-compliant (Lead-free, Halogen-free).
- (2) The standard lead finish is NiPdAu.
- (3) The device used in the above example is a CAT1232LPV-GT3 (SOIC 8-Lead, NiPdAu, Tape & Reel).
- (4) For additional package and temperature options, please contact your nearest ON Semiconductor Sales office.
- (5) The SOIC 16-Lead package is only available in Matte-Tin finish.

ON Semiconductor and are registered trademarks of Semiconductor Components Industries, LLC (SCILLC) or its subsidiaries in the United States and/or other countries. SCILLC owns the rights to a number of patents, trademarks, copyrights, trade secrets, and other intellectual property. A listing of SCILLC's product/patent coverage may be accessed at [www.onsemi.com/site/pdf/Patent-Marking.pdf](http://www.onsemi.com/site/pdf/Patent-Marking.pdf). SCILLC reserves the right to make changes without further notice to any products herein. SCILLC makes no warranty, representation or guarantee regarding the suitability of its products for any particular purpose, nor does SCILLC assume any liability arising out of the application or use of any product or circuit, and specifically disclaims any and all liability, including without limitation special, consequential or incidental damages. "Typical" parameters which may be provided in SCILLC data sheets and/or specifications can and do vary in different applications and actual performance may vary over time. All operating parameters, including "Typicals" must be validated for each customer application by customer's technical experts. SCILLC does not convey any license under its patent rights nor the rights of others. SCILLC products are not designed, intended, or authorized for use as components in systems intended for surgical implant into the body, or other applications intended to support or sustain life, or for any other application in which the failure of the SCILLC product could create a situation where personal injury or death may occur. Should Buyer purchase or use SCILLC products for any such unintended or unauthorized application, Buyer shall indemnify and hold SCILLC and its officers, employees, subsidiaries, affiliates, and distributors harmless against all claims, costs, damages, and expenses, and reasonable attorney fees arising out of, directly or indirectly, any claim of personal injury or death associated with such unintended or unauthorized use, even if such claim alleges that SCILLC was negligent regarding the design or manufacture of the part. SCILLC is an Equal Opportunity/Affirmative Action Employer. This literature is subject to all applicable copyright laws and is not for resale in any manner.

### PUBLICATION ORDERING INFORMATION

#### LITERATURE FULFILLMENT:

Literature Distribution Center for ON Semiconductor  
P.O. Box 61312, Phoenix, Arizona 85082-1312 USA  
Phone: 480-829-7710 or 800-344-3860 Toll Free USA/Canada  
Fax: 480-829-7709 or 800-344-3867 Toll Free USA/Canada  
Email: [orderlit@onsemi.com](mailto:orderlit@onsemi.com)

**N. American Technical Support:** 800-282-9855 Toll Free  
USA/Canada

**Japan:** ON Semiconductor, Japan Customer Focus Center  
2-9-1 Kamimeguro, Meguro-ku, Tokyo, Japan 153-0051  
Phone: 81-3-5773-3850

**ON Semiconductor Website:** <http://onsemi.com>

**Order Literature:** <http://www.onsemi.com/litorder>

For additional information, please contact your  
local Sales Representative.

**CAT1232LP/D**