



Chipsmall Limited consists of a professional team with an average of over 10 year of expertise in the distribution of electronic components. Based in Hongkong, we have already established firm and mutual-benefit business relationships with customers from,Europe,America and south Asia,supplying obsolete and hard-to-find components to meet their specific needs.

With the principle of “Quality Parts,Customers Priority,Honest Operation,and Considerate Service”,our business mainly focus on the distribution of electronic components. Line cards we deal with include Microchip,ALPS,ROHM,Xilinx,Pulse,ON,Everlight and Freescale. Main products comprise IC,Modules,Potentiometer,IC Socket,Relay,Connector.Our parts cover such applications as commercial,industrial, and automotives areas.

We are looking forward to setting up business relationship with you and hope to provide you with the best service and solution. Let us make a better world for our industry!



Contact us

Tel: +86-755-8981 8866 Fax: +86-755-8427 6832

Email & Skype: info@chipsmall.com Web: www.chipsmall.com

Address: A1208, Overseas Decoration Building, #122 Zhenhua RD., Futian, Shenzhen, China



CB Type Intelligent Battery Chargers

With the CB Battery Charger Line, Altech offers a highly reliable battery management solution. Operating at single phase Input Voltages of 115-230-277 VAC, the devices supply an Output of 12VDC and up to 35A or 24VDC and up to 20A.

Equipped with microcontrollers, the CB line offers fully automated multi-stage charging that will expand the battery's life significantly. Several diagnostic and monitoring features ensure easy handling and a high amount of transparency during daily operation.

Altech's CB line battery chargers are based on the switching technology which allows much higher efficiency as well as smaller and lighter devices. Additionally, several standard safety and protection features ensure safe installation and operation.

Features:

- Fully automated charging
- Three charging modes
- Compact, rugged metal case
- Available in 12VDC and 24VDC
- Suitable for most common battery types
- Adjustable charging current
- Easy battery diagnosis and fault identification either by LED or external devices connected to fault status contacts
- High efficiency up to 91% through switching technology
- Several output protection features such as short circuit, overload, deep battery discharge etc.
- DIN rail mounting
- Small size
- 3 year warranty

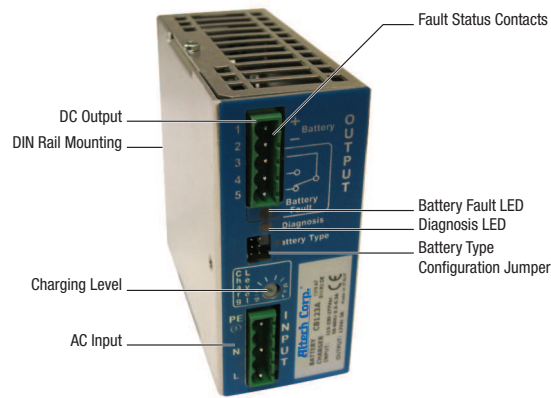

Battery Selection Chart

Battery type	1.2 Ah	3.2 Ah	7.2 Ah	12 Ah
Load 1.5 A	20	60	200	400
Load 3 A	8	30	120	240
Load 5 A	3	15	55	100
Load 7.5 A	2	10	30	60
Load 10 A	-	7	20	45
Load 12 A	-	3	12	30
Load 15 A	-	-	9	20
Load 20 A	-	-	7	13

BUFFERING (MINUTE) TIME

PSC Class 2 Series
Compact Housing

PSA Flex Series
1 Phase

PSB Flex Series
2 & 3 Phase

PS-S Slim Series
Plastic Housing

PS Low Profile Series
Plastic Housing

PS Industrial Series
1, 2 & 3 Phase

PS C & W Series
1 and 2 Phase

CB Type
DC UPS Systems

CB Type
Battery Chargers

Accessories

Appendix

CB120W CB240W CB480W: Smart Battery Chargers

Thank you for having chosen one of our products for your work.

We are certain that it will give the utmost satisfaction and be a notable help on the job.



and after sell. Each device is suited for all battery types, jumper selection sets a predefined curves for: Open Lead Acid, Sealed Lead Acid, Gel, Ni-Cd and Ni-Mh. A rugged casing with bracket for DIN rail mounting provide IP20 protection degree.

General Description

The CB series is a "Switching technology" and "Battery Care philosophy" since many years parts of the know-how ADEL system, led to the development of this advanced multi-stage battery charging, completely automatic and suited to meet the most advanced requirements of battery manufacturers. The Battery Care concept is based on algorithms that implement rapid and automatic cycle of battery charging, battery charge optimization during time, flat batteries recovery and real time diagnostic during installation and operation. The Real Time Auto-diagnostic system, monitoring battery faults such as, elements in short circuit, accidental reverse polarity connection, disconnection of the battery, they can easily be detected and removed by help of Blink Code of Diagnosis Led; during the installation

Main Characteristics

- Input: Single-phase 115 – 230 Vac
- Output Battery: charging: 24 Vdc 5A – 10A – 20 A
12 Vdc 10 – 35 A;
- Suited for the following battery types: Open Lead Acid, Sealed Lead Acid, Lead Gel, Ni-Cd and Ni-Mh
- Automatic diagnostic of battery status. Charging curve IUoUO, constant voltage and constant current Battery Life Test function (Battery Care)
- Switching technology-
- Three charging levels: Boost, Trickle and Recovery
- Protected against short circuit, Over Load and inverted polarity
- Signal output (contact free) for discharged or damaged battery
- Signal output (contact free) for Mains or Back-Up
- Protection degree IP20 - DIN rail; Space saving

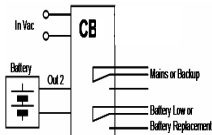
**Safety and warning notes**

WARNING – Explosion Hazard Do not disconnect Equipment unless power has been switched off or the area is known to be non-hazardous.



WARNING – Explosion Hazard. Substitution of components may impair suitability for class I, Division 2.

WARNING – Switch off the system before connecting the module. Never work on the machine when it is live. The device must be installed in accordance with UL508. The device must have a suitable isolating facility outside the power supply unit, via which can be switched to idle. Danger of fatal Injury!

Connection (terminal and wiring):

Cable Connection: The following cable cross-sections may be used:

	Solid (mm ²)	Stranded (mm ²)	AWG	Torque (Nm)	Stripping Length	All in One (Size)	1 Phase L N PE Input AC	1 Phase L N PE Input AC
In:	0.2 – 2.5	0.2 – 2.5	24 – 14	0.5 – 0.6 Nm	7 mm	Size 1 and 2		
	4.0	6.0	30 – 10	0.8 – 1.0 Nm	7 mm	Size 3		
Out:	0.2 – 2.5	0.2 – 2.5	24 – 14	0.5 – 0.6 Nm	7 mm	Size 1 and 2		
	4.0	6.0	30 – 10	0.8 – 1.0 Nm	7 mm	Size 3		
Signal:	0.2 – 2.5	0.2 – 2.5	24 – 14	0.5 – 0.6 Nm	7 mm	All types		

The connection is made by the screw type 2.5 mm² or 4.0 mm² (CB2420A – CB1235A) terminal blocks. Use only copper cables that are designed for operating temperatures of > 75 °C. Wiring terminal shall be marked to indicate the proper connection for the power supply.

Output Power connections:

Normal connection

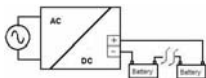

Typical application for CBxyyy device:
 N°1 battery (12 Vdc) for CB12yy;
 N°2 battery (12 Vdc) connected in Series for CB24yy;

Operating and Display Element:

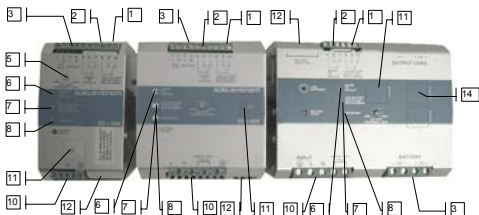

No. 10: Input AC Port pin. L – N:

1 Phase Switching Power Supplies L, N, PE ⚡
 Size 2 and Size 3 BRIDGE ONLY for input 115 Vac, and connect L, N, PE ⚡

No. 3: Battery Connection Port:

Connect the battery between pin. 3 (-) and 4 (+)
 One battery (12 Vdc) for CB12yy;
 Two battery (12 Vdc) connected in Series for CB24yy;

No. 1, 2 Signal Ports (output Isolated):

Connections for,
 No. 2: Mains/Back Up: Input Mains On/Off. Contact: 5,6,7
 No. 1: Low Battery, Fault connections systems, Battery replacement. Contact: 8,9,10

Relay Contact Rating:

Max.DC:1: 30 Vdc 1 A; AC1: 60 Vac 1A : Resistive load (EN 60947-4-1)
 Min.1mA at 5 Vdc: Min. permissive load

Signal Output port true table:		Port N°2 - Led N°6 Mains/Back-Up		Port N°1 - Led N°7 Fault Battery	
		5-6 Closed	5-7 Closed	8-9 Closed (OK)	8-10 Closed
Mains Input Vac	ON	■ - led off		■ - led off	
	OFF		■ - led On (1)	■ - led off	
The battery in BackUP it is less than 30% cap?	YES		■ - led On		■ - led On
	NO		■ - led On	■ - led off	
Battery or system Fault?	YES	■ - led off			■ - led On (2)
	NO	■ - led off		■ - led off	

Note:

(1) For better efficiency of the system, filter relay Mains/Back up with a delay of at least 5 seconds before give alarm Main Lost, example: connection to PLC.

(2) See Diagnosis Led

No. 6, 7 and 8 Display Signals

No.6: Led Mains/Back Up: Input Mains On/Off

No.7: Led Low Battery(capacity less than 30%), Fault connections systems, Battery replacement.

No.8: Led Battery charge mode,

Led Diagnosis of the system through "blinking code" signal

Monitoring Control Chart:	State	LED Diagnosis (No.8)	LED Battery Fault (No.7)
Charging Type	Trickle	1 Blink/sec	OFF
	Boost	2 Blink/sec	OFF
	Recovery	5 Blink/sec	OFF
Auto diagnosis of the system	Reverse polarity or high battery Voltage (over 32.5Vdc for CB24xx)	1 Blink/pause I	ON
	Battery No connected	2 Blink/pause II	ON
	Element in Short Circuit	3 Blink/pause III	ON
	Bad battery; Internal impedance Bad or Bad battery wire connection.	5 Blink/pause IIIII	ON
	Life test not possible	6 Blink/pause IIIII	ON
	Bad thermal sensor	7 Blink/pause IIIII	ON
	Internal fault	9 Blink/pause IIIII	ON
	CAN bus error	11 Blink/pause IIIII	
	Life test not possible; Parallel mode on Slave Device	12 Blink/pause IIIII	
	Bad battery wire connection; Parallel mode on Slave Device	13 Blink/pause IIIII	

No. 12: Battery Management Configurations

Preliminary Operations: One device for all battery types.

Completely automatic, all devices are suitable to charge most batteries types thank to User Selectable charging curves. They can charge open lead acid, sealed lead acid, Gel and Ni-Cd, Ni-MH batteries. It is possible to change or add other charging curves connecting the device to a portable PC.

Caution: Switch off the system before Setting the jumper.

Battery Type Selection	Jumper Position (Size 1 and Size 3)	Jumper Position (Size 2)	Trickle/Float charge (Volt/Cell)	Fast/Bulk charge (Volt/Cell)
Open Lead			2.23	2.40
Sealed Lead Low			2.25	2.40
Sealed Lead High			2.27	2.40
Gel Battery			2.30	2.40
Gel Battery (1)			2.30	2.40
NiCd - NiMh (1)			10% I _{max} Trimmer	1.70~(12V);1.5~(24V)
Functional Setting	Function			
Battery Life test ON			Jumper present: Life test enabled.	
Fast Charge Enable			Jumper present: fast charge enabled.	
Fast Recovery Charge (2)		Not available	Jumper present: Fast Recovery Charge, enabled only for Size 3. Possibility to recharge the battery also when the voltage is close to Zero with the maximum power of the device.	

Notice:

- Be care full, in NiCd-NiMh Option, the Sealed Lead High charging curve is deleted.
NiCd-NiMh (Options to be defined by Order). End-of-charge determined by negative ΔV detection of battery voltage (-5mV/cell). If no negative ΔV but only a "flat" profile is detected fast charge is terminated after 10 min.

General end-of-charge timeout set to 16 hours. Trickle charge current is regulated at 10% of max current corresponding to trimmer position. In order to detect end-of-charge negative ΔV , charging current must be set at least at 30% of nominal battery capacity (0,3 C); with lower values of charging current negative ΔV detection is not guaranteed.

- 2 Jumper selection n.7 is available only on CB480W (Size 3)

No. 5: Charging Level Current:



It is possible to set the max recharging current for the batteries by trimmer (Charging Level). The current adjustment goes from 10% + 100% of In. Set the maximum charging current between 10% and 20% of the battery capacity.

No. 11: Auxiliary Output

RJ 45 behind the label in SIZE 1 and SIZE 3; remove the window label to find the connector.

For SIZE 2: CB2410 require /ARJ code for RJ45 connector.

It is possible to connect:

- Temperature sensor, for ambient temperature charging compensation. With this it is possible to activate the specifications of the EN54-4 firing norm.
- Connection for external display to remote N° 3 led of the internal device.



No. 14: Auxiliary Output "Aux 2"

Present only in CB2420A and CB1235A it is provided of CAN2.0A connection.

Connection for external Intelligent display.

Battery Care

The Battery Care philosophy is based on algorithms that implement rapid and automatic charging, battery charge optimization during time, flat batteries recovery and real time diagnostic during installation and operation. The Real Time Auto-diagnostic system, monitoring battery faults such as, elements in short circuit, accidental reverse polarity connection, disconnection of the battery, they can easily be detected and removed by help of Blink Code of Diagnosis Led; during the installation and after sell. Each device is suited for all battery types, by means of jumpers it is possible setting predefined curves for Open Lead Acid, Sealed Lead Acid, Gel, Ni-Cd and Ni-Mh (option). They guarantee battery reliability in time by continuously testing the internal impedance status, avoids any possible risk of damages and grants also a permanent, reliable and safe connection of the battery to the power supply. The system, through a battery stimulation circuit with algorithms of evaluation of the detected parameter, is able to recognize sulphated batteries or batteries with a short-circuited element.

Battery Test: Automatic. Every 60 sec. check battery connection. Every 220 minute in trickle charge, make the test of the battery efficiency. The fault is signaled with relay commutation and diagnosis led blinking.

Diagnostic Type Checks:

Check for accidental disconnection of the battery cables:

CBxxyy detects accidental disconnection.

Battery not connected:

CBxxyy detects if the battery is not connected.

Test of quality wire connections:

During trickle charge the quality (resistance) on the battery connection is checked every 20 sec. This to detect if the cable connection has been properly made.

Battery in Open Circuit or Sulphated:

Every 220 minute CBxxyy tests the internal impedance, in trickle charging mode.

Reverse Polarity check:

If the battery it is connected with inverted polarity, CBxxyy is automatically protected.

Test of battery voltage connections:

Appropriate voltage check, to prevent connection of wrong battery types, more or less than the nominal voltage.

End of Charge check

When the battery it is completely full, the device automatically switch in trickle charging mode.

Check for Battery Cells in short circuit

Thanks to specific algorithms of evaluation, the CBxxyy recognize batteries with cells in internal short circuit. In trickle charge every 2 hours test of element in short circuit.

Diagnosis of battery and device

All CBxxyy devices support the user during installation and operation. A Blink code of Diagnosis Led allows to discriminate among various possible faults.

Error conditions, "LED Battery Fault" ON and "LED Diagnosis" blinking with sequence; see Display Signal section.

Charging Curve

Automatic multi-stage operation and real time diagnostic allows fast recharge and recovery of deep discharged batteries, adding value and reliability to the system hosting the CBxxx device. The type of charging is Voltage stabilized and Current stabilized IUoUo.

Three charging modes are identified by a flashing code on a Diagnosis LED.

	State	Diagnosis LED	Battery Fault LED
Charging Type	Trickle	1 Blink/sec	OFF
	Boost	2 Blink/sec	OFF
	Recovery	5 Blink/sec	OFF

CB Charging Diagram

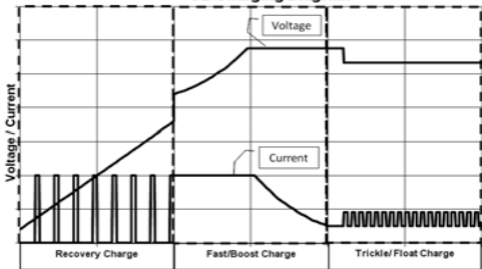

Compensation Recharges in temperature

(For SIZE 2: CB2410 require /ARJ code)

Connecting to RJ45 Auxiliary Output the cable RJTEMP (supplied separately), the CB will vary the voltage of battery charging in depending of the temperature:

CBI Model	Fast Charge	Trickle charge
CBI12xx (12Vdc)	-2.5mV/°C	-1.5mV/°C
CBI24xx (24Vdc)	-5mV/°C	-3mV/°C
CBI48xx (48Vdc)	-10mV/°C	-6mV/°C

The sensor place on cable RJTEMP must be applied on the battery.

If the sensor is not connected or if the sensor is defective, the led Low Batt is on and the led Diagnosis continues to show the status of the battery: trickle charge, fast charge or recovery charge.

Protection Features

On the primary side: the device is equipped whit an internal fuse. If the internal fuse is activated, it is most probable that there is a fault in the device. If happen, the device must be checked in the factory.

On the secondary side Battery: The device is electrically protected against short circuits and overload.

Inversion polarity: the module is automatically protected against inversion of battery polarity.

Deep discharge : not possible. The unit disconnects the battery when a minimum voltage level is reached.

Thermal behaviour

Surrounding air temperature 50°C. For ambient temperature of over 50°C, the output current must be reduced by 2.5% per °C. Max 70°C At the temperature of 70°C the output current will be 50% of In. The equipment does not switch off in case of ambient temperature above 70°C or thermal overload. The devices are protected for Over temperature conditions "worst case"; in this situations the device Shut-down the output and automatic restart when temperature inside fall.

Standards and Certification

Electrical Safety:

Assembling device: UL508, IEC/EN 60950 (VDE 0805) and EN 50178 (VDE 0160).

Installation according: IEC/EN 60950.

Input / Output separation: SELV EN 60950-1 and PELV EN 60204-1. Double or reinforced insulation.

EMC Standards Immunity:

EN 61000-4-2, EN 61000-4-3, EN 61000-4-4, EN 61000-4-5.

EMC Standards Emission:

EN 61000-6-4, EN 61000-6-3, EN 61000-3-2 (see data sheet for each device)

Standards Conformity:

Safety of Electrical Equipment Machines: EN 60204-1.

☐ The CE mark in According to EMC 2004/108/EC and Low voltage directive 2006/95/EEC

Norms and Certifications

In Conformity to: IEC/EN 60335-2-29 Battery chargers; EN60950 / UL1950; Electrical safety EN54-4 Fire Detection and fire alarm systems; 89/336/EEC EMC Directive; 2006/95/EC (Low Voltage); DIN41773 (Charging cycle); Emission: IEC 61000-6-4; Immunity: IEC 61000-6-2. CE.





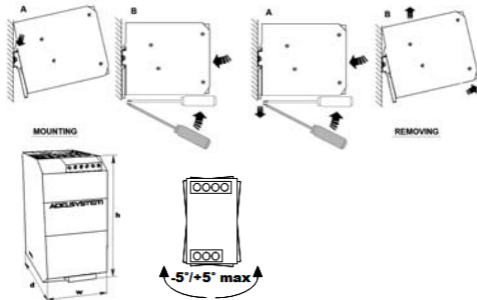

Rail Mounting:



All modules must have a minimum vertical and horizontal distance of 10 cm to this power supply in order to guarantee sufficient auto convection. Depending on the ambient temperature and load of the device, the temperature of the housing can become very high!



CB Battery Charger

					
Input (Volt)	115 – 230Vac	115 – 230Vac	115 – 230Vac	115 – 230Vac	115 – 230Vac
Output (Vdc – A – W)	12Vdc – 10A – 120W	12Vdc – 35A – 480W	24Vdc – 5A – 120W	24Vdc – 10A – 240W	24Vdc – 20A – 480W
Model	CB1210A	CB1235A	CB245A	CB2410AC	CB2420A
INPUT DATA					
Nominal Input Voltage / Tensione d'ingresso nominale	115 – 230Vac	115 – 230Vac	115 – 230Vac	115 – 230Vac	115 – 230Vac
Input Voltage Range / Campo di funzionamento	90 – 264Vac	90 – 264Vac	90 – 264Vac	90 – 135Vac 180 – 264Vac	90 – 135Vac 180 – 264Vac
Inrush Current (Vn and In Load) I_{in} / Corrente di Inserzione	$\leq 16 \text{ A} \leq 5\text{msec}$	$\leq 35 \text{ A} \leq 5\text{msec}$	$\leq 16 \text{ A} \leq 5\text{msec}$	$\leq 16 \text{ A} \leq 5\text{msec}$	$\leq 35 \text{ A} \leq 5\text{msec}$
Frequency /Frequenza di Ingresso	47 – 63 Hz $\pm 6\%$	47 – 63 Hz $\pm 6\%$	47 – 63 Hz $\pm 6\%$	47 – 63 Hz $\pm 6\%$	47 – 63 Hz $\pm 6\%$
Input Current (115 – 230Vac) / Assorbimento	2.4 – 1.2A	8.0 – 4.2A	2.4 – 1.2A	3.3 – 2.2A	8.0 – 4.2A
Internal Fuse / Fusibile Interno (non sostituibile)	4A	10A	4A	6.3A	10A
External Fuse (recommended)/ Fusibile Esterno raccomandato	10A	16A	10A	16A	16A
OUTPUT DATA					
Output Vdc / I_N / Tensione di uscita Vdc / I_N	12Vdc – 10A	12Vdc – 35A	24Vdc – 5A	24Vdc – 10A	24Vdc – 20A
Minimum load / Carico minimo	No	No	No	No	No
Efficiency (50% of In) / Rendimento tipico	$\geq 89\%$	$\geq 91\%$	$\geq 89\%$	$\geq 88\%$	$\geq 91\%$
Short-circuit protection / Protezione contro il corto circuito	Yes	Yes	Yes	Yes	Yes
Over Load protection / Protezione sovraccarico	Yes	Yes	Yes	Yes	Yes
Over Voltage Output protection / Protezione sovratensione in uscita	Yes	Yes	Yes	Yes	Yes
Reverse battery protection / Protezione inversione batteria	Yes	Yes	Yes	Yes	Yes
Detection of element in short circuit / Relevazione elemento in corto circuito	Yes	Yes	Yes	Yes	Yes
BATTERY CHARGER OUTPUT / USCITA CARICA BATTERIA					
Boost – Bulk charge (Typ. at I_N) / Carica Veloce (1)	14.4Vdc	14.4Vdc	28.8Vdc	28.8Vdc	28.8Vdc
Max.Time Boost–Bulk charge (Typ. at I_N) / Tempo massimo Carica Veloce	15h	15h	15h	15h	15h
Min.Time Boost–Bulk charge (Typ. at I_N) / Tempo minimo Carica Veloce	1min.	1min.	1min.	1min.	1min.
Trickle-Float charge (Typ. at I_N) / Carica di mantenimento (1)	13.75Vdc	13.75Vdc	27.5Vdc	27.5Vdc	27.5Vdc
Recovery Charge / Carica di recupero	2 – 9Vdc	2 – 9Vdc	2 – 18Vdc	2 – 18Vdc	2 – 18Vdc
Switching on after applying mains voltage	2.5sec.		2.5sec.	2.5sec.	
End of charging current Bulk - Absorption to Float - Trickle	0.3A		0.3A	0.3A	
Start up with capacitive load / Start up con carichi capacitivi	$\leq 30.000\mu\text{F}$		$\leq 30.000\mu\text{F}$	$\leq 30.000\mu\text{F}$	
Residual Ripple / Ripple Residuo	$\leq 60 \text{ mVpp}$		$\leq 60 \text{ mVpp}$	$\leq 60 \text{ mVpp}$	
Charging max I_{batt} / Corrente max. di Carica	10A $\pm 5\%$	35A $\pm 5\%$	5A $\pm 5\%$	10A $\pm 5\%$	20A $\pm 5\%$
Charging current Limiting I_N (I_{adj}) / Limitazione Corrente di Carica	Yes	Yes	Yes	Yes	Yes
Quiescent Current / Consumo da batteria max.	$\leq 5\text{mA}$	$\leq 5\text{mA}$	$\leq 5\text{mA}$	$\leq 5\text{mA}$	$\leq 5\text{mA}$
SIGNAL OUTPUT (RELAY) / SEGNALAZIONE RELÈ USCITA					
Main or Backup Power	Yes	Yes	Yes	Yes	Yes
Low Battery and Fault Battery	Yes	Yes	Yes	Yes	Yes
Main or Backup - Fault Battery	No	No	No	No	No
AUXILIARY OUTPUT (RJ 45 CONNECTION) FOR:					
Temp. Charging probe / Carica Compensata in Temperatura	Yes	Yes	Yes	Yes	Yes
Voltage drop compensation / Comp. Tensione di ricarica	Yes	Yes	Yes	Yes	Yes
Remote monitoring display / Display Esterno	Yes	Yes	Yes	Yes	Yes
CLIMATIC DATA					
Ambient Temperature operation / Temperatura Ambiente di Lavoro	-25 – +70°C	-25 – +70°C	-25 – +70°C	-25 – +70°C	-25 – +70°C
De rating $T^3 > (I_N)$ / De rating $T^3 > (I_N)$	$> 50^\circ 2.5\% \text{ } ^\circ\text{C}$	$> 50^\circ 2.5\% \text{ } ^\circ\text{C}$	$> 50^\circ 2.5\% \text{ } ^\circ\text{C}$	$> 50^\circ 2.5\% \text{ } ^\circ\text{C}$	$> 50^\circ 2.5\% \text{ } ^\circ\text{C}$
Automatic De rating / De rating Automatico	No	No	No	No	No
De rating at 115Vac / De rating a 115Vac					
Ambient Temperature Storage / Temperatura max. Magazzino	-40 – +85°C	-40 – +85°C	-40 – +85°C	-40 – +85°C	-40 – +85°C
Humidity at 25 °C / Umidità	95% to 25°C	95% to 25°C	95% to 25°C	95% to 25°C	95% to 25°C
Cooling / Raffreddamento					
GENERAL DATA					
Isolation Voltage (IN / OUT) / Tensione di Isolamento (IN / OUT)	3000Vac	3000Vac	3000Vac	3000Vac	3000Vac
Isolation Voltage(IN / PE) / Tensione di Isolamento(IN / TERRA)	1605Vac	1605Vac	1605Vac	1605Vac	1605Vac
Isolation Voltage(OUT / PE) / Tensione di Isolamento(OUT/TERRA)	500Vac	500Vac	500Vac	500Vac	500Vac
Protection Class (EN/IEC 60529) / Protezione Classe	IP 20	IP 20	IP 20	IP 20	IP 20
Reliability (MTBF IEC 61709) / Affidabilità	$> 300\,000 \text{ h}$	$> 300\,000 \text{ h}$	$> 300\,000 \text{ h}$	$> 300\,000 \text{ h}$	$> 300\,000 \text{ h}$
Pollution Degree Environment / Grado d'inquinamento ambientale	2	2	2	2	2
Connection Terminal Blocks Screw Type / Dimensione morsetti	2.5mm	4mm	2.5mm	2.5mm	4mm
Protection class (with PE connected) / Grado di protezione (con cavo di terra collegato)	I	I	I	I	I
Dimension (w-h-d)/Dimensioni (l-h-p) mm	65x115x135 mm	150x115x135 mm	65x115x135 mm	100x115x135 mm	150x115x135 mm
Weight / Peso	0.65 kg approx	1.5 kg approx	0.65 kg approx	0.85 kg approx	1.5 kg approx
Safety Standard Approval / Conformità ed Approvazioni	CE	CE	CE	CE	CE
CONNECTION DIAGRAM / SCHEMA DI CONNESSIONE					
					

(1) - Depend on jumper selection