



Chipsmall Limited consists of a professional team with an average of over 10 year of expertise in the distribution of electronic components. Based in Hongkong, we have already established firm and mutual-benefit business relationships with customers from,Europe,America and south Asia,supplying obsolete and hard-to-find components to meet their specific needs.

With the principle of “Quality Parts,Customers Priority,Honest Operation,and Considerate Service”,our business mainly focus on the distribution of electronic components. Line cards we deal with include Microchip,ALPS,ROHM,Xilinx,Pulse,ON,Everlight and Freescale. Main products comprise IC,Modules,Potentiometer,IC Socket,Relay,Connector.Our parts cover such applications as commercial,industrial, and automotives areas.

We are looking forward to setting up business relationship with you and hope to provide you with the best service and solution. Let us make a better world for our industry!



Contact us

Tel: +86-755-8981 8866 Fax: +86-755-8427 6832

Email & Skype: info@chipsmall.com Web: www.chipsmall.com

Address: A1208, Overseas Decoration Building, #122 Zhenhua RD., Futian, Shenzhen, China



THE INFORMATION CONTAINED HEREON IS THE PROPERTY OF EMERSON NETWORK POWER, RECEIPT, POSSESSION OR TRANSMITTAL OF THIS DRAWING DOES NOT LICENSE OR IMPLY ANY RIGHT TO USE, SELL, PROTOTYPE OR MANUFACTURE FROM THIS INFORMATION. NO REPRODUCTIONS OR PUBLICATION OF THIS INFORMATION, IN WHOLE OR IN PART, SHALL BE MADE WITHOUT WRITTEN AUTHORIZATION FROM EMERSON NETWORK POWER.

DWG NO. 3-0272 SH 1

REVISIONS			
REV	DESCRIPTION	DATE	APPROVED
C	ECO 12672	1/7/99	C.N.M.
D	ECO 52441	6/10/10	T. KOHLER

DASH NO	FIG NO	CONNECTOR TYPE	MODEL NO
-1	1	2-LUG	CBBJ79TL
-2	2	3-LUG	CBBJ79
-3	3	THREADED	CBBJ379
-4	4	4-LUG	CBBJ79FL
-5	1	2-LUG	CBBJ79TLS
-6	2	3-LUG	CBBJ79S
-7	3	THREADED	CBBJ379S
-8	4	4-LUG	CBBJ79FLS

**RECOMMENDED
MTG HOLE PATTERN
SCALE 2:1**

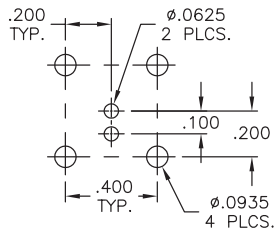

**RECOMMENDED
PANEL CUTOUT
SCALE 2:1**

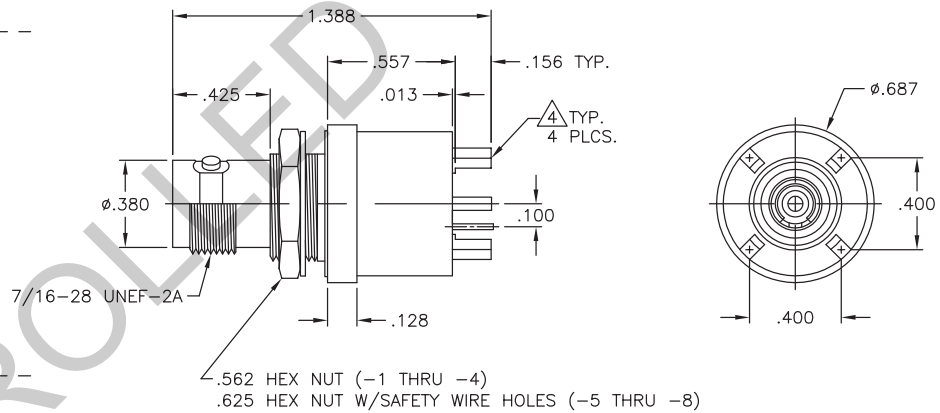
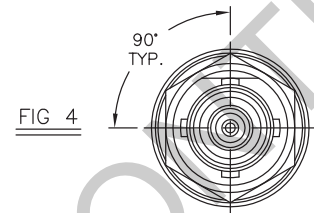
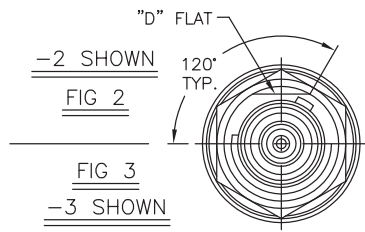
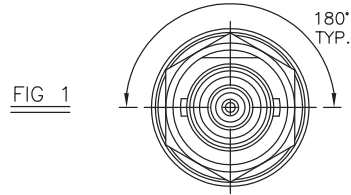
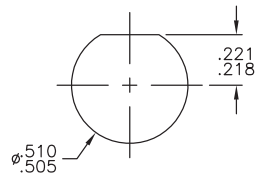

- PRE-TINNED, .0015 MAXIMUM THICKNESS WITH SN63 OR EQUIVALENT SOLDER, PER QQ-S-571, TO WITHIN .060 MAXIMUM OF SHOULDER, AFTER PLATING.
- MAXIMUM PANEL THICKNESS .109
- FEMALE 2/3/4 LUG & THREADED CONCENTRIC BOARD AND NON-INSULATED BULKHEAD MOUNT RECEPTACLE.

△ FINISH: TFS-1A (NICKEL)

SURFACE AREA (IN ²)	UNLESS OTHERWISE SPECIFIED DIMENSIONS ARE IN INCHES TOLERANCES ARE:			
	FRACTIONS	DECIMALS		
	±	.XX ±	±	
		.XXX ±	.005	
		.XXXX ±	.0010	
MATERIAL	SIGNATURES	DATE	CBBJ79/TL/FL/379 CBBJ79S/TLS/FLS/379S	
	DRAWN BY C. WALLACE	6/17/10	SIZE B	REV D
FINISH △	CHECKED BY	APPROVED BY	CAGE CODE 14949	DWG NO. 3-0272
DO NOT SCALE DRAWING	APPROVED BY		SCALE 2:1	DATE: 4/9/85
			SHEET 1 OF 2	