



Chipsmall Limited consists of a professional team with an average of over 10 year of expertise in the distribution of electronic components. Based in Hongkong, we have already established firm and mutual-benefit business relationships with customers from,Europe,America and south Asia,supplying obsolete and hard-to-find components to meet their specific needs.

With the principle of “Quality Parts,Customers Priority,Honest Operation,and Considerate Service”,our business mainly focus on the distribution of electronic components. Line cards we deal with include Microchip,ALPS,ROHM,Xilinx,Pulse,ON,Everlight and Freescale. Main products comprise IC,Modules,Potentiometer,IC Socket,Relay,Connector.Our parts cover such applications as commercial,industrial, and automotives areas.

We are looking forward to setting up business relationship with you and hope to provide you with the best service and solution. Let us make a better world for our industry!



Contact us

Tel: +86-755-8981 8866 Fax: +86-755-8427 6832

Email & Skype: info@chipsmall.com Web: www.chipsmall.com

Address: A1208, Overseas Decoration Building, #122 Zhenhua RD., Futian, Shenzhen, China



CBS50

CB S 50 48 12 - □

① ② ③ ④ ⑤ ⑥

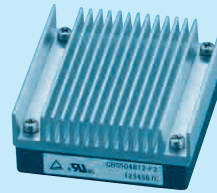
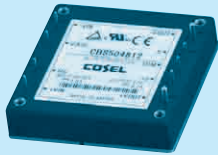

- ① Series name
- ② Single output
- ③ Output wattage
- ④ Input voltage
24 :DC18 - 36V
48 :DC36 - 76V
- ⑤ Output voltage
- ⑥ Optional
- R :with Remote ON/OFF
Positive logic control
- T :with Mounting hole
φ 3.4 thru
- :with Addition of a
Heat sink

MODEL	CBS50241R8	CBS50242R5	CBS502403	CBS502405	CBS502412	CBS502415	CBS502424	CBS502428
MAX OUTPUT WATTAGE[W]	21.06	29.25	38.6	50.0	50.4	51.0	50.4	50.4
DC OUTPUT	1.8V 11.7A	2.5V 11.7A	3.3V 11.7A	5V 10A	12V 4.2A	15V 3.4A	24V 2.1A	28V 1.8A

SPECIFICATIONS

	MODEL	CBS50241R8	CBS50242R5	CBS502403	CBS502405	CBS502412	CBS502415	CBS502424	CBS502428	
INPUT	VOLTAGE[V]	DC18 - 36								
	CURRENT[A]	1.24typ	1.58typ	2.04typ	2.48typ	2.39typ	2.44typ	2.41typ	2.41typ	
	EFFICIENCY[%]	71typ	77typ	79typ	84typ	88typ	87typ	87typ	87typ	
OUTPUT	VOLTAGE[V]	1.8	2.5	3.3	5	12	15	24	28	
	CURRENT[A]	11.7	11.7	11.7	10	4.2	3.4	2.1	1.8	
	LINE REGULATION[mV]	10max	10max	10max	10max	24max	30max	48max	56max	
	LOAD REGULATION[mV]	10max	10max	10max	10max	24max	30max	48max	56max	
	RIPPLE[mVp-p]	-20 to +100°C	80max	80max	80max	80max	120max	120max	120max	120max
		-40 to -20°C	120max	120max	120max	120max	150max	150max	150max	150max
	RIPPLE NOISE[mVp-p]	-20 to +100°C	120max	120max	120max	120max	150max	150max	150max	150max
		-40 to -20°C	200max	200max	200max	200max	200max	200max	250max	250max
	TEMPERATURE REGULATION[mV]	0 to +65°C	35max	35max	35max	50max	120max	150max	240max	280max
		-40 to +100°C	66max	66max	66max	100max	240max	300max	480max	560max
DRIFT[mV]	16max	16max	16max	20max	40max	60max	90max	90max		
START-UP TIME[ms]	200max (DCIN 24V, Io=100%)									
OUTPUT VOLTAGE ADJUSTMENT RANGE[V]	Fixed (TRM pin open), adjustable by external resistor									
OUTPUT VOLTAGE SETTING[V]	1.70 - 1.98	1.98 - 2.75	1.98 - 3.63	3.0 - 5.5	7.2 - 13.2	9.0 - 16.5	14.4 - 26.4	16.8 - 30.8		
OVERCURRENT PROTECTION	Works over 105% of rating and recovers automatically									
OVERVOLTAGE PROTECTION[V]	2.16 - 2.88	3.00 - 4.00	4.00 - 5.50	5.75 - 7.00	13.80 - 16.80	17.25 - 21.00	27.60 - 33.60	32.20 - 39.20		
REMOTE SENSING	Provided									
REMOTE ON/OFF	Provided (Negative logic L : ON, H : OFF)									

MODEL	CBS50481R8	CBS50482R5	CBS504803	CBS504805	CBS504812	CBS504815	CBS504824	CBS504828
MAX OUTPUT WATTAGE[W]	21.06	29.25	38.6	50.0	50.4	51.0	50.4	50.4
DC OUTPUT	1.8V 11.7A	2.5V 11.7A	3.3V 11.7A	5V 10A	12V 4.2A	15V 3.4A	24V 2.1A	28V 1.8A

SPECIFICATIONS

	MODEL	CBS50481R8	CBS50482R5	CBS504803	CBS504805	CBS504812	CBS504815	CBS504824	CBS504828	
INPUT	VOLTAGE[V]	DC36 - 76								
	CURRENT[A]	0.62typ	0.79typ	1.01typ	1.23typ	1.18typ	1.21typ	1.19typ	1.19typ	
	EFFICIENCY[%]	71typ	77typ	80typ	85typ	89typ	88typ	88typ	88typ	
OUTPUT	VOLTAGE[V]	1.8	2.5	3.3	5	12	15	24	28	
	CURRENT[A]	11.7	11.7	11.7	10	4.2	3.4	2.1	1.8	
	LINE REGULATION[mV]	10max	10max	10max	10max	24max	30max	48max	56max	
	LOAD REGULATION[mV]	10max	10max	10max	10max	24max	30max	48max	56max	
	RIPPLE[mVp-p]	-20 to +100°C	80max	80max	80max	80max	120max	120max	120max	120max
		-40 to -20°C	120max	120max	120max	120max	150max	150max	150max	150max
	RIPPLE NOISE[mVp-p]	-20 to +100°C	120max	120max	120max	120max	150max	150max	150max	150max
		-40 to -20°C	200max	200max	200max	200max	200max	200max	250max	250max
	TEMPERATURE REGULATION[mV]	0 to +65°C	35max	35max	35max	50max	120max	150max	240max	280max
		-40 to +100°C	66max	66max	66max	100max	240max	300max	480max	560max
DRIFT[mV]	16max	16max	16max	20max	40max	60max	90max	90max		
START-UP TIME[ms]	200max (DCIN 48V, Io=100%)									
OUTPUT VOLTAGE ADJUSTMENT RANGE[V]	Fixed (TRM pin open), adjustable by external resistor									
OUTPUT VOLTAGE SETTING[V]	1.70 - 1.98	1.98 - 2.75	1.98 - 3.63	3.0 - 5.5	7.2 - 13.2	9.0 - 16.5	14.4 - 26.4	16.8 - 30.8		
OVERCURRENT PROTECTION	Works over 105% of rating and recovers automatically									
OVERVOLTAGE PROTECTION[V]	2.16 - 2.88	3.00 - 4.00	4.00 - 5.50	5.75 - 7.00	13.80 - 16.80	17.25 - 21.00	27.60 - 33.60	32.20 - 39.20		
REMOTE SENSING	Provided									
REMOTE ON/OFF	Provided (Negative logic L : ON, H : OFF)									

GENERAL SPECIFICATIONS

ISOLATION	INPUT-OUTPUT	DC1,500V or AC1,000V 1minute, Cutoff current = 10mA, DC500V 50MΩ min(20±15°C)
	INPUT-CASE PIN, BASE PLATE	DC1,500V or AC1,000V 1minute, Cutoff current = 10mA, DC500V 50MΩ min(20±15°C)
	OUTPUT-CASE PIN, BASE PLATE	AC500V 1minute, Cutoff current = 100mA, DC500V 50MΩ min (20±15°C)
ENVIRONMENT	OPERATING TEMP.,HUMID.AND ALTITUDE	-40 to +100°C (On aluminum base plate), 20 - 95%RH (Non condensing) (Refer to DERATING CURVE), 3,000m (10,000feet) max
	STORAGE TEMP.,HUMID.AND ALTITUDE	-40 to +100°C, 20 - 95%RH (Non condensing), 9,000m (30,000feet) max
	VIBRATION	10 - 55Hz, 49.0m/s ² (5G), 3minutes period, 60minutes each along X, Y and Z axis
	IMPACT	196.1m/s ² (20G), 11ms, once each along X, Y and Z axis
SAFETY	AGENCY APPROVALS	UL60950-1, C-UL, EN60950-1
OTHERS	CASE SIZE/WEIGHT	57.9×12.7×61.0mm [2.28×0.5×2.4 inches](W×H×D) / 83g max
	COOLING METHOD	Conduction cooling (e.g. heat radiation from the aluminum base plate to the attached heat sink)

- *1 At rated input(DC24V,DC48V) and rated load.
- *2 Ripple and ripple noise is measured by using measuring board with recommended capacitor Co & the film capacitor 0.1 μF. Measured by 20MHz oscilloscope or Ripple-Noise meter (Equivalent to KEISOKU-GIKEN:RM101).
- *3 Drift is the change in DC output for an eight hour period after a half-hour warm-up at 25°C, with the input voltage held constant at the rated input/output.
- *4 When the input voltage is in the range of DC18 - 20V, DC36 - 40V, output voltage adjustment range is 60 - 105% (except for 1R8/2R5).

External view

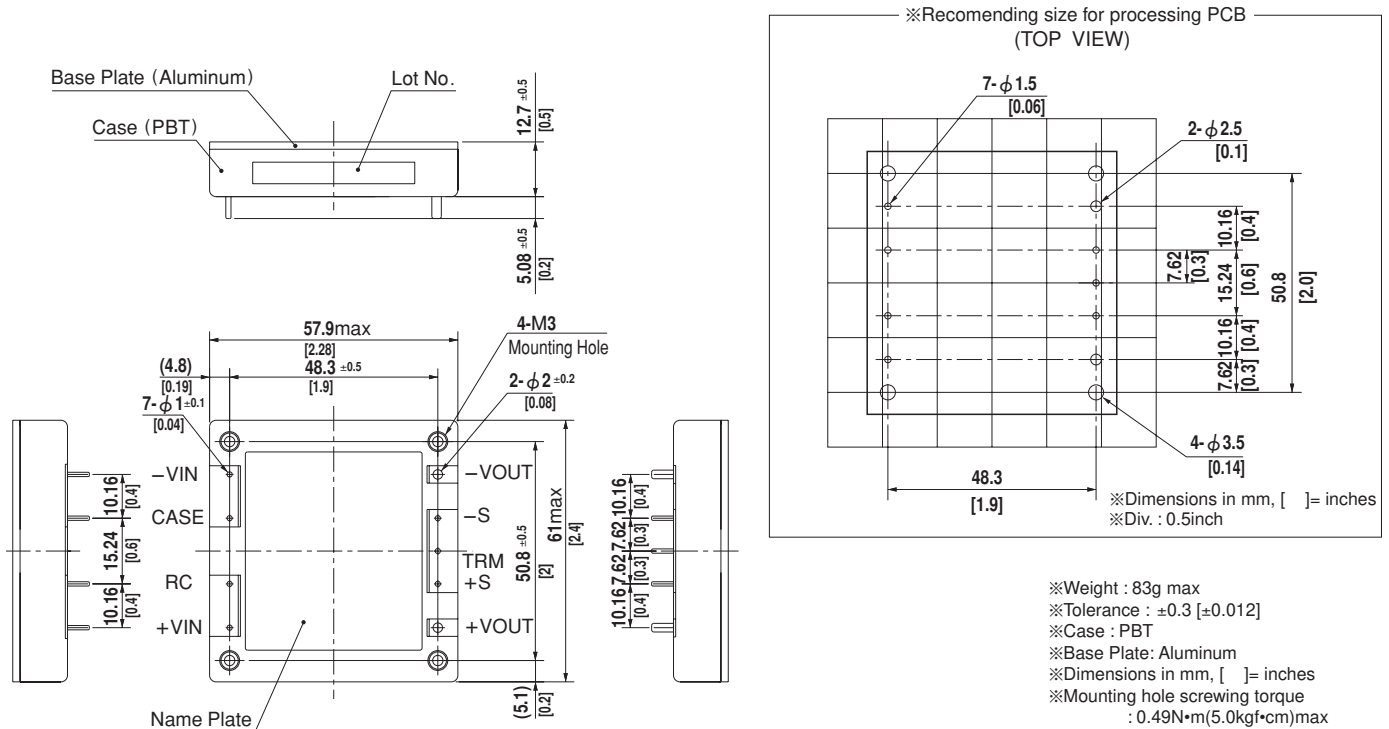

Performance data

■ INPUT CURRENT CHARACTERISTICS (CBS502428)

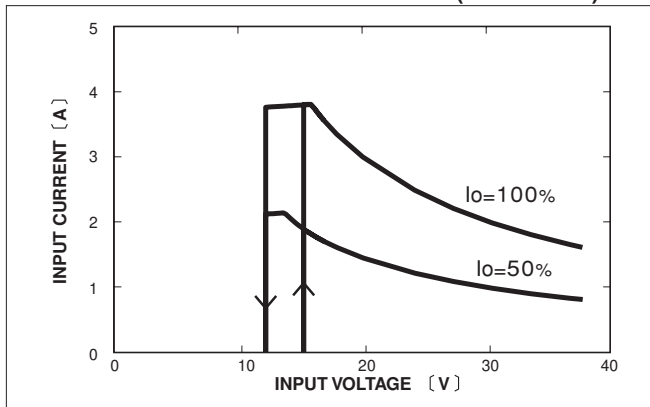

■ INPUT CURRENT CHARACTERISTICS (CBS504828)

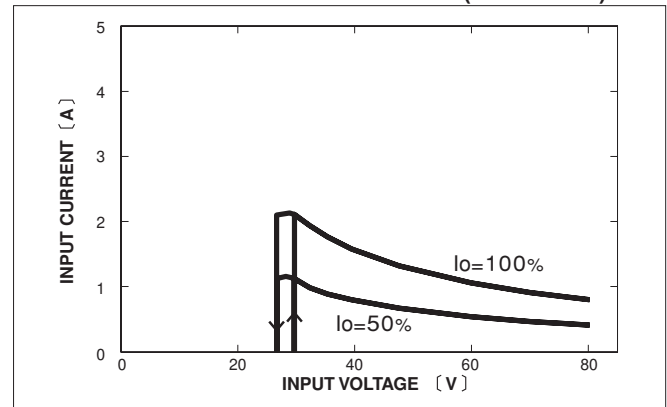

CBS100

CB S 100 48 12 - □

① ② ③ ④ ⑤ ⑥

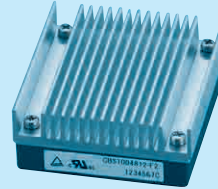
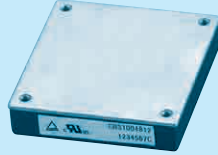
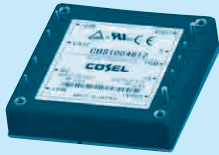

- ① Series name
- ② Single output
- ③ Output wattage
- ④ Input voltage
24:DC18 - 36V
48:DC36 - 76V
- ⑤ Output voltage
- ⑥ Optional
- R :with Remote ON/OFF
Positive logic control
- T :with Mounting hole
φ 3.4 thru
- :with Addition of a
Heat sink

MODEL	CBS100241R8	CBS100242R5	CBS1002403	CBS1002405	CBS1002412	CBS1002415	CBS1002424	CBS1002428
MAX OUTPUT WATTAGE[W]	42.12	58.50	77.2	100.0	100.8	100.5	100.8	100.8
DC OUTPUT	1.8V 23.4A	2.5V 23.4A	3.3V 23.4A	5V 20A	12V 8.4A	15V 6.7A	24V 4.2A	28V 3.6A

SPECIFICATIONS

	MODEL	CBS100241R8	CBS100242R5	CBS1002403	CBS1002405	CBS1002412	CBS1002415	CBS1002424	CBS1002428	
INPUT	VOLTAGE[V]	DC18 - 36								
	CURRENT[A]	2.47typ	3.17typ	4.07typ	5.02typ	4.77typ	4.81typ	4.83typ	4.83typ	
	EFFICIENCY[%]	71typ	77typ	79typ	83typ	88typ	87typ	87typ	87typ	
OUTPUT	VOLTAGE[V]	1.8	2.5	3.3	5	12	15	24	28	
	CURRENT[A]	23.4	23.4	23.4	20	8.4	6.7	4.2	3.6	
	LINE REGULATION[mV]	10max	10max	10max	10max	24max	30max	48max	56max	
	LOAD REGULATION[mV]	10max	10max	10max	10max	24max	30max	48max	56max	
	RIPPLE[mVp-p]	-20 to +100℃	80max	80max	80max	80max	120max	120max	120max	120max
		-40 to -20℃	120max	120max	120max	120max	150max	150max	150max	150max
	RIPPLE NOISE[mVp-p]	-20 to +100℃	120max	120max	120max	120max	150max	150max	150max	150max
		-40 to -20℃	200max	200max	200max	200max	200max	200max	250max	250max
	TEMPERATURE REGULATION[mV]	0 to +65℃	35max	35max	35max	50max	120max	150max	240max	280max
		-40 to +100℃	66max	66max	66max	100max	240max	300max	480max	560max
DRIFT[mV]		16max	16max	16max	20max	40max	60max	90max	90max	
START-UP TIME[ms]		200max (DCIN 24V, Io=100%)								
OUTPUT VOLTAGE ADJUSTMENT RANGE[V]		Fixed (TRM pin open), adjustable by external resistor								
OUTPUT VOLTAGE SETTING[V]		1.70 - 1.98	1.98 - 2.75	1.98 - 3.63	3.0 - 5.5	7.2 - 13.2	9.0 - 16.5	14.4 - 26.4	16.8 - 30.8	
OVERCURRENT PROTECTION		Works over 105% of rating and recovers automatically								
OVERVOLTAGE PROTECTION[V]		2.16 - 2.88	3.00 - 4.00	4.00 - 5.50	5.75 - 7.00	13.80 - 16.80	17.25 - 21.00	27.60 - 33.60	32.20 - 39.20	
REMOTE SENSING		Provided								
REMOTE ON/OFF		Provided (Negative logic L : ON, H : OFF)								

MODEL	CBS100481R8	CBS100482R5	CBS1004803	CBS1004805	CBS1004812	CBS1004815	CBS1004824	CBS1004828
MAX OUTPUT WATTAGE[W]	42.12	58.50	77.2	100.0	100.8	100.5	100.8	100.8
DC OUTPUT	1.8V 23.4A	2.5V 23.4A	3.3V 23.4A	5V 20A	12V 8.4A	15V 6.7A	24V 4.2A	28V 3.6A

SPECIFICATIONS

	MODEL	CBS100481R8	CBS100482R5	CBS1004803	CBS1004805	CBS1004812	CBS1004815	CBS1004824	CBS1004828	
INPUT	VOLTAGE[V]	DC36 - 76								
	CURRENT[A]	1.24typ	1.58typ	2.01typ	2.48typ	2.36typ	2.38typ	2.39typ	2.39typ	
	EFFICIENCY[%]	71typ	77typ	80typ	84typ	89typ	88typ	88typ	88typ	
OUTPUT	VOLTAGE[V]	1.8	2.5	3.3	5	12	15	24	28	
	CURRENT[A]	23.4	23.4	23.4	20	8.4	6.7	4.2	3.6	
	LINE REGULATION[mV]	10max	10max	10max	10max	24max	30max	48max	56max	
	LOAD REGULATION[mV]	10max	10max	10max	10max	24max	30max	48max	56max	
	RIPPLE[mVp-p]	-20 to +100℃	80max	80max	80max	80max	120max	120max	120max	120max
		-40 to -20℃	120max	120max	120max	120max	150max	150max	150max	150max
	RIPPLE NOISE[mVp-p]	-20 to +100℃	120max	120max	120max	120max	150max	150max	150max	150max
		-40 to -20℃	200max	200max	200max	200max	200max	200max	250max	250max
	TEMPERATURE REGULATION[mV]	0 to +65℃	35max	35max	35max	50max	120max	150max	240max	280max
		-40 to +100℃	66max	66max	66max	100max	240max	300max	480max	560max
DRIFT[mV]		16max	16max	16max	20max	40max	60max	90max	90max	
START-UP TIME[ms]		200max (DCIN 48V, Io=100%)								
OUTPUT VOLTAGE ADJUSTMENT RANGE[V]		Fixed (TRM pin open), adjustable by external resistor								
OUTPUT VOLTAGE SETTING[V]		1.70 - 1.98	1.98 - 2.75	1.98 - 3.63	3.0 - 5.5	7.2 - 13.2	9.0 - 16.5	14.4 - 26.4	16.8 - 30.8	
OVERCURRENT PROTECTION		Works over 105% of rating and recovers automatically								
OVERVOLTAGE PROTECTION[V]		2.16 - 2.88	3.00 - 4.00	4.00 - 5.50	5.75 - 7.00	13.80 - 16.80	17.25 - 21.00	27.60 - 33.60	32.20 - 39.20	
REMOTE SENSING		Provided								
REMOTE ON/OFF		Provided (Negative logic L : ON, H : OFF)								

GENERAL SPECIFICATIONS

ISOLATION	INPUT-OUTPUT	DC1,500V or AC1,000V 1minute, Cutoff current = 10mA, DC500V 50MΩ min(20±15°C)
	INPUT-CASE PIN, BASE PLATE	DC1,500V or AC1,000V 1minute, Cutoff current = 10mA, DC500V 50MΩ min(20±15°C)
	OUTPUT-CASE PIN, BASE PLATE	AC500V 1minute, Cutoff current = 100mA, DC500V 50MΩ min (20±15°C)
ENVIRONMENT	OPERATING TEMP., HUMID. AND ALTITUDE	-40 to +100°C (On aluminum base plate), 20 - 95%RH (Non condensing) (Refer to DERATING CURVE), 3,000m (10,000feet) max
	STORAGE TEMP., HUMID. AND ALTITUDE	-40 to +100°C, 20 - 95%RH (Non condensing), 9,000m (30,000feet) max
	VIBRATION	10 - 55Hz, 49.0m/s ² (5G), 3minutes period, 60minutes each along X, Y and Z axis
	IMPACT	196.1m/s ² (20G), 11ms, once each along X, Y and Z axis
SAFETY	AGENCY APPROVALS	UL60950-1, C-UL, EN60950-1
OTHERS	CASE SIZE/WEIGHT	57.9 × 12.7 × 61.0mm [2.28 × 0.5 × 2.4 inches] (W × H × D) / 83g max
	COOLING METHOD	Conduction cooling (e.g. heat radiation from the aluminum base plate to the attached heat sink)

- *1 At rated input(DC24V, DC48V) and rated load.
- *2 Ripple and ripple noise is measured by using measuring board with recommended capacitor Co & the film capacitor 0.1 μF. Measured by 20MHz oscilloscope or Ripple-Noise meter (Equivalent to KEISOKU-GIKEN:RM101).
- *3 Drift is the change in DC output for an eight hour period after a half-hour warm-up at 25°C, with the input voltage held constant at the rated input/output.
- *4 When the input voltage is in the range of DC18 - 20V, DC36 - 40V output voltage adjustment range is 60 - 105% (except for 1R8/2R5).

External view

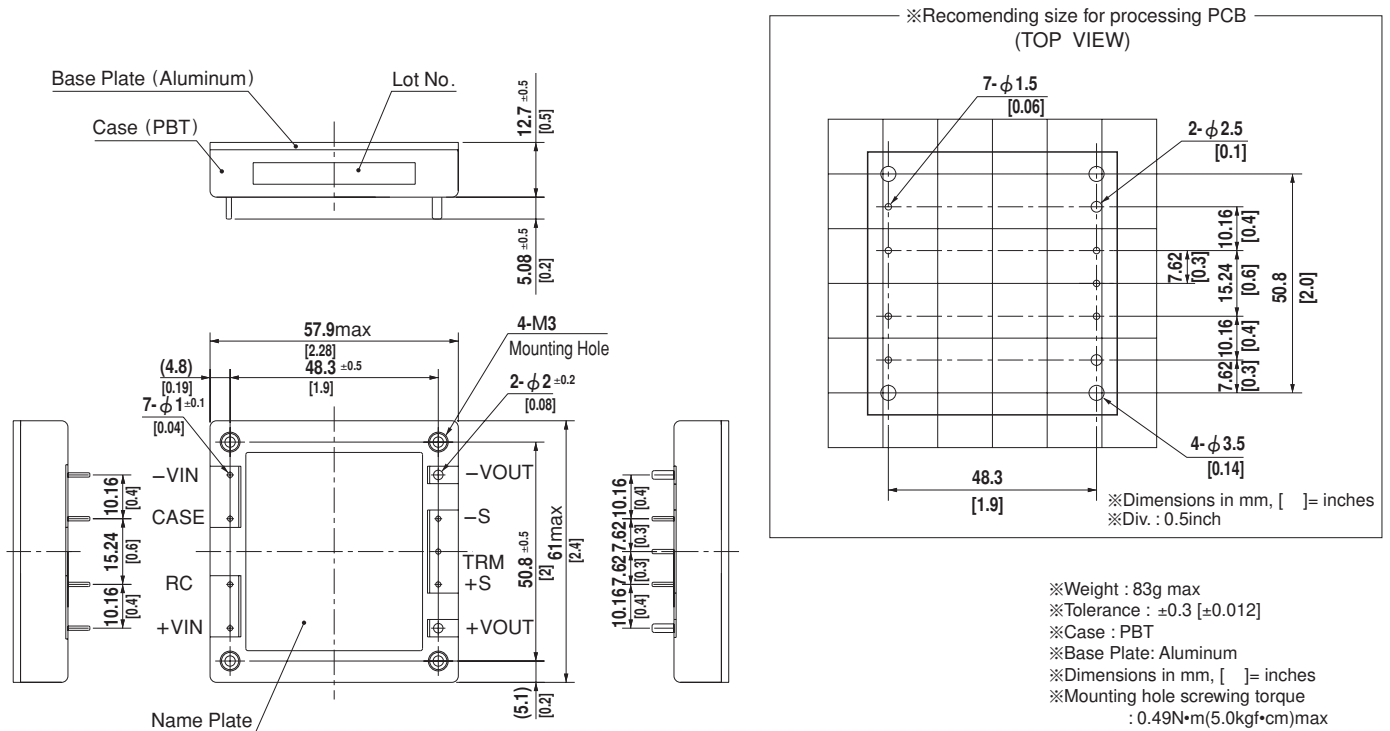

Performance data

■ INPUT CURRENT CHARACTERISTICS (CBS1002428)

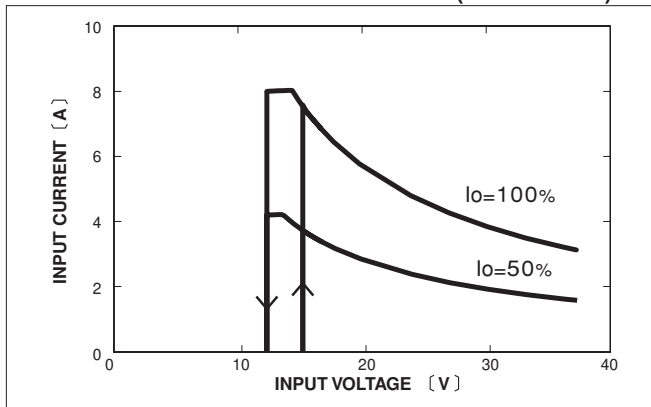

■ INPUT CURRENT CHARACTERISTICS (CBS1004828)

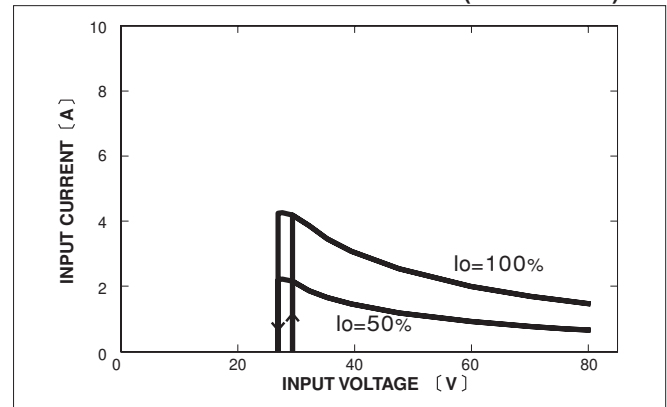

CBS200

CB S 200 48 12 -

① ② ③ ④ ⑤ ⑥

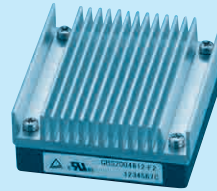
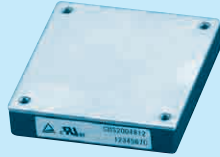
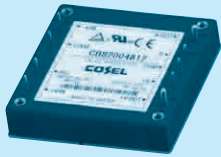

- ① Series name
 - ② Single output
 - ③ Output wattage
 - ④ Input voltage
24:DC18 - 36V
48:DC36 - 76V
 - ⑤ Output voltage
 - ⑥ Optional
- R :with Remote ON/OFF
Positive logic control
T :with Mounting hole
φ 3.4 thru
 :with Addition of a Heat sink

MODEL	CBS200241R8	CBS200242R5	CBS2002403	CBS2002405	CBS2002412	CBS2002415	CBS2002424	CBS2002428
MAX OUTPUT WATTAGE[W]	63.00	87.50	115.5	150.0	200.4	201.0	201.6	201.6
DC OUTPUT	1.8V 35A	2.5V 35A	3.3V 35A	5V 30A	12V 16.7A	15V 13.4A	24V 8.4A	28V 7.2A

SPECIFICATIONS

	MODEL	CBS200241R8	CBS200242R5	CBS2002403	CBS2002405	CBS2002412	CBS2002415	CBS2002424	CBS2002428	
INPUT	VOLTAGE[V]	DC18 - 36								
	CURRENT[A]	3.75typ	4.80typ	6.09typ	7.62typ	9.60typ	9.63typ	9.66typ	9.66typ	
	EFFICIENCY[%]	70typ	76typ	79typ	82typ	87typ	87typ	87typ	87typ	
OUTPUT	VOLTAGE[V]	1.8	2.5	3.3	5	12	15	24	28	
	CURRENT[A]	35	35	35	30	16.7	13.4	8.4	7.2	
	LINE REGULATION[mV]	10max	10max	10max	10max	24max	30max	48max	56max	
	LOAD REGULATION[mV]	10max	10max	10max	10max	24max	30max	48max	56max	
	RIPPLE[mVp-p]	-20 to +100°C	80max	80max	80max	80max	120max	120max	120max	120max
		-40 to -20°C	120max	120max	120max	120max	150max	150max	150max	150max
	RIPPLE NOISE[mVp-p]	-20 to +100°C	120max	120max	120max	120max	150max	150max	150max	150max
		-40 to -20°C	200max	200max	200max	200max	200max	200max	250max	250max
	TEMPERATURE REGULATION[mV]	0 to +65°C	35max	35max	35max	50max	120max	150max	240max	280max
		-40 to +100°C	66max	66max	66max	100max	240max	300max	480max	560max
DRIFT[mV]	16max	16max	16max	20max	40max	60max	90max	90max		
START-UP TIME[ms]	200max (DCIN 24V, Io=100%)									
OUTPUT VOLTAGE ADJUSTMENT RANGE[V]	Fixed (TRM pin open), adjustable by external resistor									
OUTPUT VOLTAGE SETTING[V]	1.70 - 1.98	1.98 - 2.75	1.98 - 3.63	3.0 - 5.5	7.2 - 13.2	9.0 - 16.5	14.4 - 26.4	16.8 - 30.8		
OVERCURRENT PROTECTION	Works over 105% of rating and recovers automatically									
OVERVOLTAGE PROTECTION[V]	2.16 - 2.88	3.00 - 4.00	4.00 - 5.50	5.75 - 7.00	13.80 - 16.80	17.25 - 21.00	27.60 - 33.60	32.20 - 39.20		
REMOTE SENSING	Provided									
REMOTE ON/OFF	Provided (Negative logic L : ON, H : OFF)									

MODEL	CBS200481R8	CBS200482R5	CBS2004803	CBS2004805	CBS2004812	CBS2004815	CBS2004824	CBS2004828	CBS2004848
MAX OUTPUT WATTAGE[W]	63.00	87.50	115.5	150.0	200.4	201.0	201.6	201.6	201.6
DC OUTPUT	1.8V 35A	2.5V 35A	3.3V 35A	5V 30A	12V 16.7A	15V 13.4A	24V 8.4A	28V 7.2A	48V 4.2A

SPECIFICATIONS

	MODEL	CBS200481R8	CBS200482R5	CBS2004803	CBS2004805	CBS2004812	CBS2004815	CBS2004824	CBS2004828	CBS2004848	
INPUT	VOLTAGE[V]	DC36 - 76									
	CURRENT[A]	1.88typ	2.40typ	3.01typ	3.77typ	4.74typ	4.76typ	4.77typ	4.77typ	4.77typ	
	EFFICIENCY[%]	70typ	76typ	80typ	83typ	88typ	88typ	88typ	88typ	88typ	
OUTPUT	VOLTAGE[V]	1.8	2.5	3.3	5	12	15	24	28	48	
	CURRENT[A]	35	35	35	30	16.7	13.4	8.4	7.2	4.2	
	LINE REGULATION[mV]	10max	10max	10max	10max	24max	30max	48max	56max	96max	
	LOAD REGULATION[mV]	10max	10max	10max	10max	24max	30max	48max	56max	96max	
	RIPPLE[mVp-p]	-20 to +100°C	80max	80max	80max	80max	120max	120max	120max	120max	200max
		-40 to -20°C	120max	120max	120max	120max	150max	150max	150max	150max	250max
	RIPPLE NOISE[mVp-p]	-20 to +100°C	120max	120max	120max	120max	150max	150max	150max	150max	250max
		-40 to -20°C	200max	200max	200max	200max	200max	200max	250max	250max	400max
	TEMPERATURE REGULATION[mV]	0 to +65°C	35max	35max	35max	50max	120max	150max	240max	280max	480max
		-40 to +100°C	66max	66max	66max	100max	240max	300max	480max	560max	960max
DRIFT[mV]	16max	16max	16max	20max	40max	60max	90max	90max	180max		
START-UP TIME[ms]	200max (DCIN 48V, Io=100%)										
OUTPUT VOLTAGE ADJUSTMENT RANGE[V]	Fixed (TRM pin open), adjustable by external resistor										
OUTPUT VOLTAGE SETTING[V]	1.70 - 1.98	1.98 - 2.75	1.98 - 3.63	3.0 - 5.5	7.2 - 13.2	9.0 - 16.5	14.4 - 26.4	16.8 - 30.8	43.2 - 52.8		
OVERCURRENT PROTECTION	Works over 105% of rating and recovers automatically										
OVERVOLTAGE PROTECTION[V]	2.16 - 2.88	3.00 - 4.00	4.00 - 5.50	5.75 - 7.00	13.80 - 16.80	17.25 - 21.00	27.60 - 33.60	32.20 - 39.20	55.20 - 67.20		
REMOTE SENSING	Provided										
REMOTE ON/OFF	Provided (Negative logic L : ON, H : OFF)										

GENERAL SPECIFICATIONS

ISOLATION	INPUT-OUTPUT	DC1,500V or AC1,000V 1minute, Cutoff current = 10mA, DC500V 50MΩ min(20±15°C)
	INPUT-CASE PIN, BASE PLATE	DC1,500V or AC1,000V 1minute, Cutoff current = 10mA, DC500V 50MΩ min(20±15°C)
	OUTPUT-CASE PIN, BASE PLATE	AC500V 1minute, Cutoff current = 100mA, DC500V 50MΩ min (20±15°C)
ENVIRONMENT	OPERATING TEMP.,HUMID.AND ALTITUDE	-40 to +100°C (On aluminum base plate), 20 - 95%RH (Non condensing) (Refer to DERATING CURVE), 3,000m (10,000feet) max
	STORAGE TEMP.,HUMID.AND ALTITUDE	-40 to +100°C, 20 - 95%RH (Non condensing), 9,000m (30,000feet) max
	VIBRATION	10 - 55Hz, 49.0m/s ² (5G), 3minutes period, 60minutes each along X, Y and Z axis
	IMPACT	196.1m/s ² (20G), 11ms, once each along X, Y and Z axis
SAFETY	AGENCY APPROVALS	UL60950-1, C-UL, EN60950-1
OTHERS	CASE SIZE/WEIGHT	57.9×12.7×61.0mm [2.28×0.5×2.4 inches] (W×H×D) / 83g max
	COOLING METHOD	Conduction cooling (e.g. heat radiation from the aluminum base plate to the attached heat sink)

- *1 At rated input(DC24V,DC48V) and rated load.
- *2 Ripple and ripple noise is measured by using measuring board with recommended capacitor Co & the film capacitor 0.1 μF. Measured by 20MHz oscilloscope or Ripple-Noise meter (Equivalent to KEISOKU-GIKEN:RM101).
- *3 Drift is the change in DC output for an eight hour period after a half-hour warm-up at 25°C, with the input voltage held constant at the rated input/output.
- *4 When the input voltage is in the range of DC18 - 20V, DC36 - 40V, output voltage adjustment range is 60 - 105% (except for 1R8/2R5/48).

External view

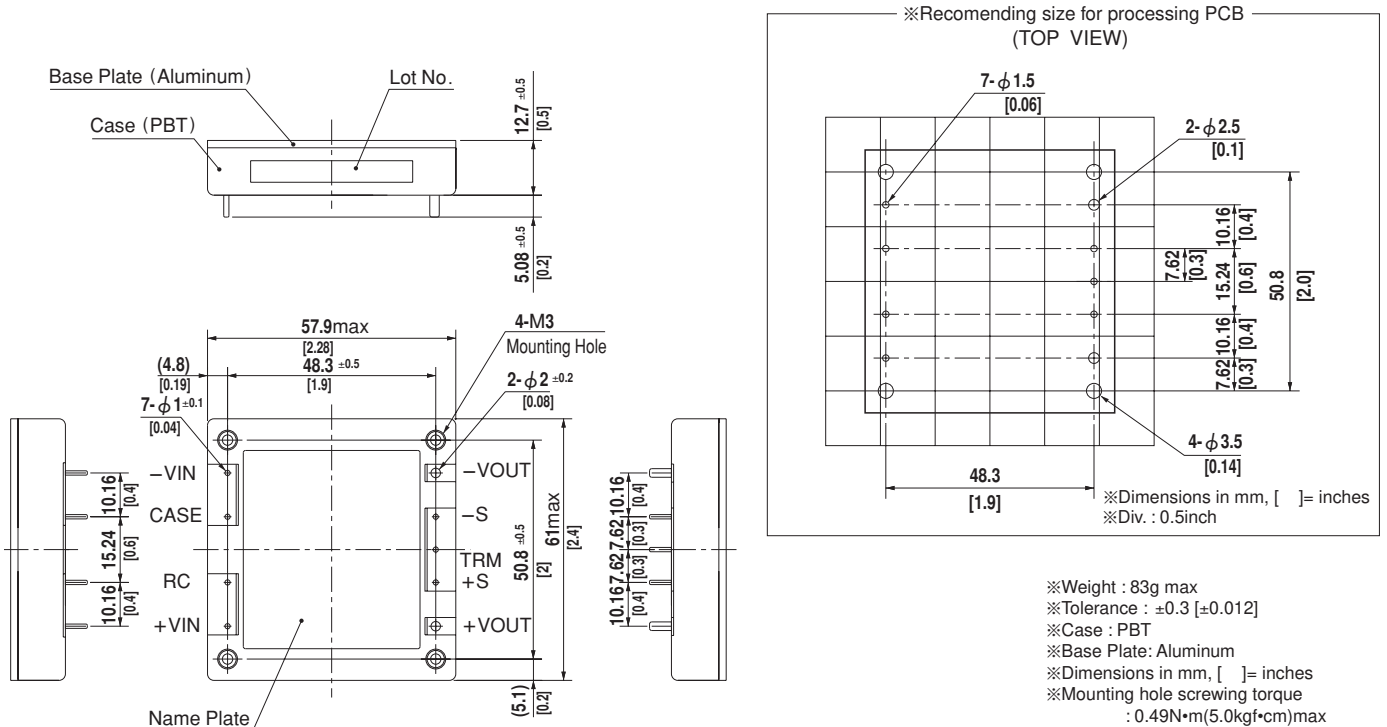

Performance data

■ INPUT CURRENT CHARACTERISTICS (CBS2002428)

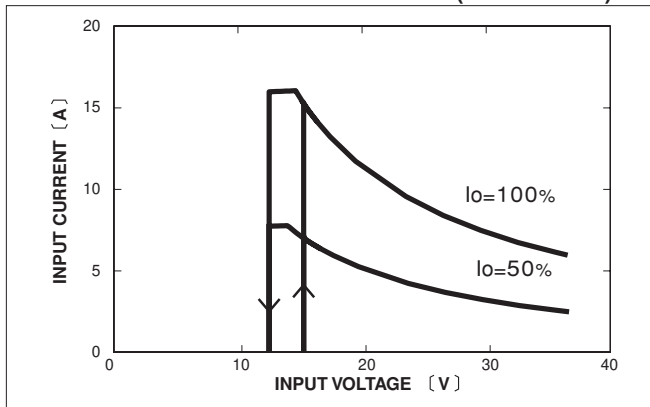

■ INPUT CURRENT CHARACTERISTICS (CBS2004828)

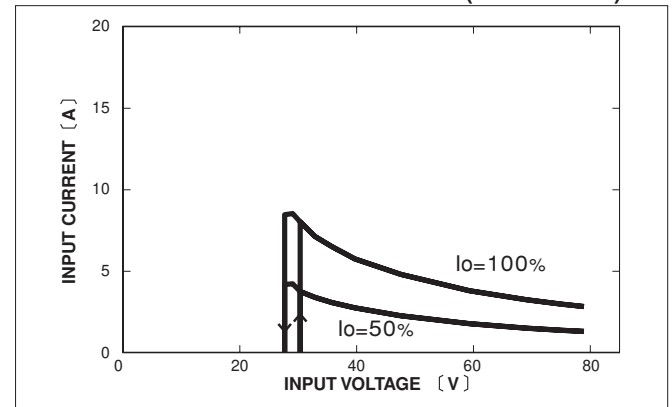

CBS350

CB S 350 48 12 - □

① ② ③ ④ ⑤ ⑥

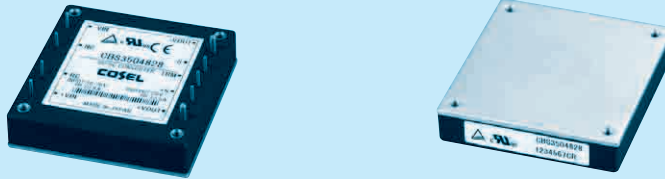

- ① Series name
- ② Single output
- ③ Output wattage
- ④ Input voltage
- ⑤ Output voltage
- ⑥ Optional
- R :with Remote ON/OFF
Positive logic control
- T :with Mounting hole
φ3.4 thru

MODEL	CBS3502412	CBS3502424	CBS3502428	CBS3502432	CBS3502448	CBS3504812	CBS3504824	CBS3504828	CBS3504832	CBS3504848
MAX OUTPUT WATTAGE[W]	300	348	350	352	302	348	348	350	352	350
DC OUTPUT	12V 25A	24V 14.5A	28V 12.5A	32V 11A	48V 6.3A	12V 29A	24V 14.5A	28V 12.5A	32V 11A	48V 7.3A

SPECIFICATIONS

	MODEL	CBS3502412	CBS3502424	CBS3502428	CBS3502432	CBS3502448	CBS3504812	CBS3504824	CBS3504828	CBS3504832	CBS3504848	
INPUT	VOLTAGE[V]	DC20 - 36					DC36 - 76					
	CURRENT[A]	*1 14.5typ	16.7typ	16.4typ	16.5typ	14.0typ	8.33typ	8.15typ	8.10typ	8.15typ	8.15typ	
	EFFICIENCY[%]	*1 86typ	87typ	89typ	89typ	90typ	87typ	89typ	90typ	90typ	91typ	
OUTPUT	VOLTAGE[V]	12	24	28	32	48	12	24	28	32	48	
	CURRENT[A]	25	14.5	12.5	11	6.3	29	14.5	12.5	11	7.3	
	LINE REGULATION[mV]	24max	48max	56max	64max	96max	24max	48max	56max	64max	96max	
	LOAD REGULATION[mV]	24max	48max	56max	64max	96max	24max	48max	56max	64max	96max	
	RIPPLE[mVp-p]	-20 to +100°C *2	120max	150max	180max	180max	300max	120max	150max	180max	180max	300max
		-40 to -20°C *2	150max	180max	220max	220max	360max	150max	180max	220max	220max	360max
		0 to 15%Load *2	240max	300max	360max	360max	600max	240max	300max	360max	360max	600max
	RIPPLE NOISE[mVp-p]	-20 to +100°C *2	150max	180max	220max	220max	360max	150max	180max	220max	220max	360max
		-40 to -20°C *2	200max	250max	280max	280max	500max	200max	250max	280max	280max	500max
		0 to 15%Load *2	300max	360max	440max	440max	720max	300max	360max	440max	440max	720max
	TEMPERATURE REGULATION[mV]	0 to +65°C	120max	240max	280max	320max	480max	120max	240max	280max	320max	480max
		-40 to +100°C	240max	480max	560max	640max	960max	240max	480max	560max	640max	960max
	DRIFT[mV]	*3 40max	90max	90max	120max	180max	40max	90max	90max	120max	180max	
START-UP TIME[ms]	200max (DCIN 24V, Io=100%)					200max (DCIN 48V, Io=100%)						
OUTPUT VOLTAGE ADJUSTMENT RANGE[V] *4	Fixed (TRM pin open), adjustable by external resistor											
	7.2 - 13.2	14.4 - 26.4	16.8 - 30.8	25.6 - 35.2	38.4 - 52.8	7.2 - 13.2	14.4 - 26.4	16.8 - 30.8	25.6 - 35.2	38.4 - 55.2		
OUTPUT VOLTAGE SETTING[V] *1	11.88 - 12.12	23.76 - 24.24	27.72 - 28.28	31.68 - 32.32	47.52 - 48.48	11.88 - 12.12	23.76 - 24.24	27.72 - 28.28	31.68 - 32.32	47.52 - 48.48		
PROTECTION CIRCUIT AND OTHERS	OVERCURRENT PROTECTION	Works over 105% of rating and recovers automatically										
	OVERVOLTAGE PROTECTION[V]	13.80 - 16.80	27.60 - 33.60	32.20 - 39.20	36.80 - 44.80	57.50 - 63.00	13.80 - 16.80	27.60 - 33.60	32.20 - 39.20	36.80 - 44.80	57.50 - 63.00	
	REMOTE SENSING	Provided										
	REMOTE ON/OFF	Provided (Negative logic L : ON, H : OFF)										
ISOLATION	INPUT-OUTPUT	DC1,500V or AC1,000V 1minute, Cutoff current = 10mA, DC500V 50MΩ min(20±15°C)										
	INPUT-BASE PLATE	DC1,500V or AC1,000V 1minute, Cutoff current = 10mA, DC500V 50MΩ min(20±15°C)										
	OUTPUT-BASE PLATE	AC500V 1minute, Cutoff current = 100mA, DC500V 50MΩ min (20±15°C)										
ENVIRONMENT	OPERATING TEMP.,HUMID.AND ALTITUDE	-40 to +100°C (On aluminum base plate), 20 - 95%RH (Non condensing) (Refer to DERATING CURVE), 3,000m (10,000feet) max										
	STORAGE TEMP.,HUMID.AND ALTITUDE	-40 to +100°C, 20 - 95%RH (Non condensing), 9,000m (30,000feet) max										
	VIBRATION	10 - 55Hz, 49.0m/s ² (5G), 3minutes period, 60minutes each along X, Y and Z axis										
	IMPACT	196.1m/s ² (20G), 11ms, once each along X, Y and Z axis										
SAFETY	AGENCY APPROVALS	UL60950-1, C-UL, EN60950-1										
OTHERS	CASE SIZE/WEIGHT	57.9 × 12.7 × 61.0mm [2.28 × 0.5 × 2.4 inches] (W × H × D) / 83g max										
	COOLING METHOD	Conduction cooling (e.g. heat radiation from the aluminum base plate to the attached heat sink)										

*1 At rated input(DC24V,DC48V), rated load, and aluminum base plate temperature 25°C.

*2 Ripple and ripple noise is measured by using measuring board with recommended capacitor Co & the film capacitor 0.1 μF. Refer to the manual.

*3 Drift is the change in DC output for an eight hour period after a half-hour warm-up at 25°C, with the input voltage held constant at the rated input/output.

*4 When the input voltage is in the range of DC20 - 22V, DC36 - 40V, output voltage is limited. Refer to the manual.

External view

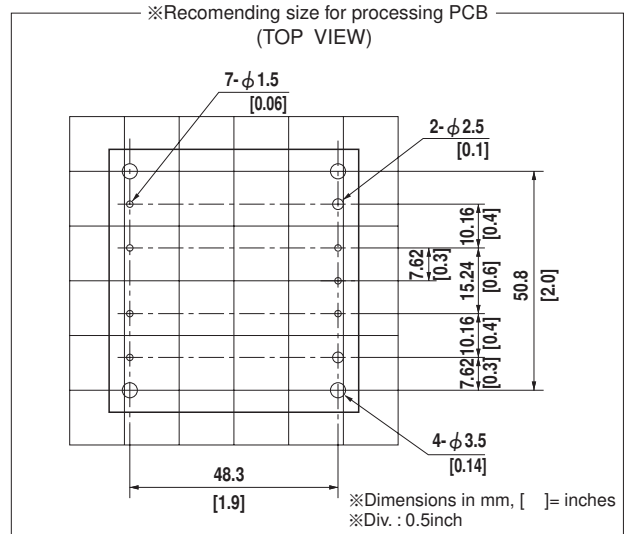
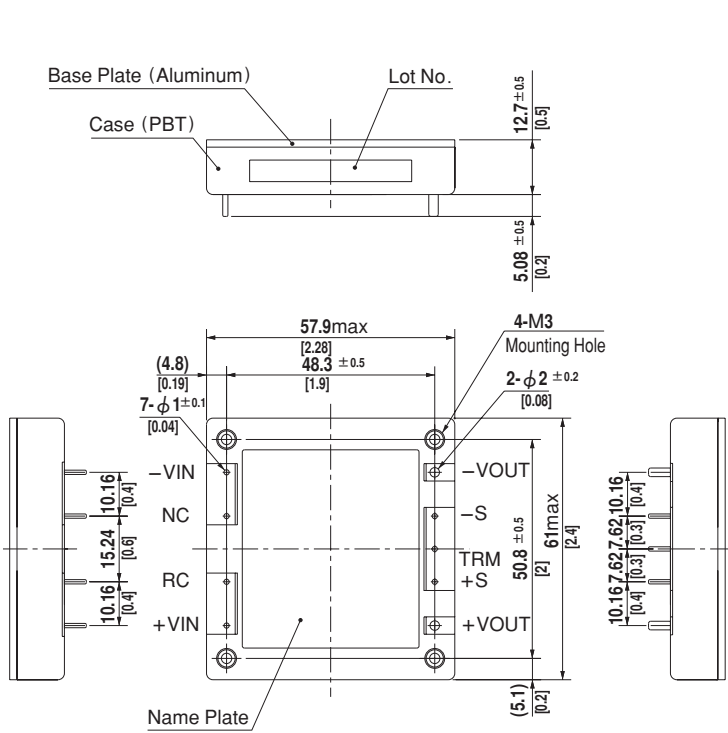

- ※Weight : 83g max
- ※Tolerance : ±0.3 [±0.012]
- ※Case : PBT
- ※Base Plate: Aluminum
- ※Dimensions in mm, []= inches
- ※Mounting hole screwing torque : 0.49N•m(5.0kgf•cm)max

CBS450

CB S 450 48 28 - □

① ② ③ ④ ⑤ ⑥



- ① Series name
- ② Single output
- ③ Output wattage
- ④ Input voltage
- ⑤ Output voltage
- ⑥ Optional
- R :with Remote ON/OFF
Positive logic control
- T :with Mounting hole
φ3.4 thru

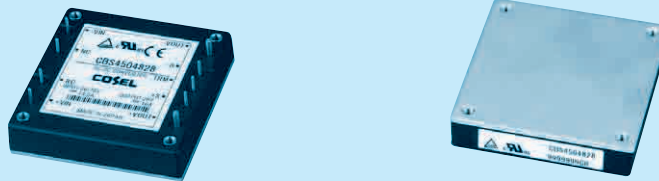

MODEL	CBS4504824	CBS4504828	CBS4504832
MAX OUTPUT WATTAGE[W]	456	448	400
DC OUTPUT	24V 19A	28V 16A	32V 12.5A

SPECIFICATIONS

	MODEL	CBS4504824	CBS4504828	CBS4504832	
INPUT	VOLTAGE[V]	DC38 - 60	DC36 - 76	DC36 - 76	
	CURRENT[A]	*1 10.6typ	10.5typ	9.3typ	
	EFFICIENCY[%]	*1 90typ	91typ	91typ	
OUTPUT	VOLTAGE[V]	24	28	32	
	CURRENT[A]	19	16	12.5	
	LINE REGULATION[mV]	48max	56max	64max	
	LOAD REGULATION[mV]	48max	56max	64max	
	RIPPLE[mVp-p]	-20 to +100°C *2	180max	210max	210max
		-40 to -20°C *2	220max	260max	260max
		0 to 15%Load *2	360max	430max	430max
	RIPPLE NOISE[mVp-p]	-20 to +100°C *2	220max	260max	260max
		-40 to -20°C *2	280max	330max	330max
		0 to 15%Load *2	440max	520max	520max
	TEMPERATURE REGULATION[mV]	0 to +65°C	240max	280max	280max
		-40 to +100°C	480max	560max	560max
	DRIFT[mV]	*3 90max	90max	120max	
START-UP TIME[ms]	200max (DCIN 48V, Io=100%)				
OUTPUT VOLTAGE ADJUSTMENT RANGE[V] *4	Fixed (TRM pin open), adjustable by external resistor				
	19.2 - 26.0	16.8 - 32.2	25.6 - 35.2		
OUTPUT VOLTAGE SETTING[V] *1	23.52 - 24.48	27.44 - 28.56	31.36 - 32.64		
PROTECTION CIRCUIT AND OTHERS	OVERCURRENT PROTECTION	Works over 105% of rating and recovers automatically			
	OVERVOLTAGE PROTECTION[V]	27.60 - 33.60	32.20 - 39.20	36.80 - 44.80	
	REMOTE SENSING	Provided			
	REMOTE ON/OFF	Provided (Negative logic L : ON, H : OFF)			
ISOLATION	INPUT-OUTPUT	DC1,500V or AC1,000V 1minute, Cutoff current = 10mA, DC500V 50MΩ min(20±15°C)			
	INPUT-BASE PLATE	DC1,500V or AC1,000V 1minute, Cutoff current = 10mA, DC500V 50MΩ min(20±15°C)			
	OUTPUT-BASE PLATE	AC500V 1minute, Cutoff current = 100mA, DC500V 50MΩ min (20±15°C)			
ENVIRONMENT	OPERATING TEMP.,HUMID.AND ALTITUDE	-40 to +100°C (On aluminum base plate), 20 - 95%RH (Non condensing) (Refer to DERATING CURVE), 3,000m (10,000feet) max			
	STORAGE TEMP.,HUMID.AND ALTITUDE	-40 to +100°C, 20 - 95%RH (Non condensing), 9,000m (30,000feet) max			
	VIBRATION	10 - 55Hz, 49.0m/s ² (5G), 3minutes period, 60minutes each along X, Y and Z axis			
SAFETY	IMPACT	196.1m/s ² (20G), 11ms, once each along X, Y and Z axis			
	AGENCY APPROVALS	UL60950-1, C-UL, EN60950-1			
OTHERS	CASE SIZE/WEIGHT	57.9×12.7×61.0mm [2.28×0.5×2.4 inches] (W×H×D) / 83g max			
	COOLING METHOD	Conduction cooling (e.g. heat radiation from the aluminum base plate to the attached heat sink)			

*1 At rated input(DC48V), rated load, and aluminum base plate temperature 25°C.

*2 Ripple and ripple noise is measured by using measuring board with recommended capacitor Co & the film capacitor 0.1 μF. Refer to the manual.

*3 Drift is the change in DC output for an eight hour period after a half-hour warm-up at 25°C, with the input voltage held constant at the rated input/output.

*4 Refer to the manual for the input range.

External view

