



Chipsmall Limited consists of a professional team with an average of over 10 year of expertise in the distribution of electronic components. Based in Hongkong, we have already established firm and mutual-benefit business relationships with customers from,Europe,America and south Asia,supplying obsolete and hard-to-find components to meet their specific needs.

With the principle of “Quality Parts,Customers Priority,Honest Operation,and Considerate Service”,our business mainly focus on the distribution of electronic components. Line cards we deal with include Microchip,ALPS,ROHM,Xilinx,Pulse,ON,Everlight and Freescale. Main products comprise IC,Modules,Potentiometer,IC Socket,Relay,Connector.Our parts cover such applications as commercial,industrial, and automotives areas.

We are looking forward to setting up business relationship with you and hope to provide you with the best service and solution. Let us make a better world for our industry!



Contact us

Tel: +86-755-8981 8866 Fax: +86-755-8427 6832

Email & Skype: info@chipsmall.com Web: www.chipsmall.com

Address: A1208, Overseas Decoration Building, #122 Zhenhua RD., Futian, Shenzhen, China



CBT-90 LEDs

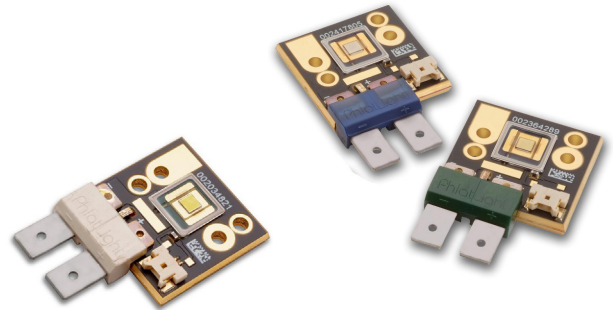

Table of Contents

- Technology Overview2
- Test Specifications2
- White Binning Structure3
- White Chromaticity Bins4
- Green, Blue Binning Structure5
- Product Shipping & Labeling Information.....6
- White Electrical Characteristics7
- White Optical and Electrical Characteristics8
- Green/Blue Optical and Electrical Characteristics.....9
- Green/Blue Lifetime and Lumen Maintenance..... 13
- Radiation Patterns 14
- Thermal Resistance 15
- Mechanical Dimensions .. 16
- Ordering Information 17

Features:

- Extremely high optical output:
 - Over 2,250 White Lumens
 - Over 1,800 Green lumens
 - Over 650 Blue Lumens
- High thermal conductivity package - junction to case thermal resistance of only 0.8°C/W
- CBT-90-W available in 5700K and 6500K Color points (typ)
- Large, monolithic chip with uniform emitting area of 9 mm²
- Unencapsulated die with low profile protective window optimizes optical coupling in etendue-limited applications
- Lumen maintenance of greater than 70% after 60,000 hours
- Environmentally friendly: RoHS and Halogen compliant

Applications

- Fiber-coupled Illumination
- Architectural and Entertainment Lighting
- Medical Lighting
- Machine Vision
- Microscopy
- Displays and Signage
- General Illumination
- Spot Lighting
- Emergency Vehicle Lighting
- Projection Systems

Technology Overview

Luminus LEDs™ benefit from a suite of innovations in the fields of chip technology, packaging and thermal management. These breakthroughs allow illumination engineers and designers to achieve solutions that are high brightness and high efficiency.

LED Technology

Luminus LED™ technology enables large area LED chips with uniform brightness over the entire LED chip surface. The optical power and brightness produced by these large monolithic chips enable solutions which replace arc and halogen lamps where arrays of traditional high power LEDs cannot.

Packaging Technology

Thermal management is critical in high power LED applications. With a thermal resistance from junction to case of 0.8° C/W, Luminus CBT-90 LEDs have the lowest thermal resistance of any LED on the market. This allows the LED to be driven at higher current densities while maintaining a low junction temperature, thereby resulting in brighter solutions and longer lifetimes.

Reliability

Luminus LEDs are one of the most reliable light sources in the world today. LEDs have passed a rigorous suite of environmental and mechanical stress tests, including mechanical shock, vibration, temperature cycling and humidity, and have been fully qualified for use in extreme high power and high current applications. With very low failure rates and median lifetimes that typically exceed 60,000 hours, Luminus LEDs are ready for even the most demanding applications. (Refer to Luminus' Reliability application note for more information.)

Environmental Benefits

Luminus LEDs help reduce power consumption and the amount of hazardous waste entering the environment. All LED products manufactured by Luminus are RoHS and REACH compliant and free of hazardous materials, including lead and mercury.

Luminus LED Test Specifications

Every Luminus LED is fully tested to ensure that it meets the high quality standards expected from Luminus' products.

Testing Temperature

Luminus core board products are measured in an equivalent way the devices will operate in a system. The device is mounted on a 40°C heat sink and allowed to reach thermal equilibrium under full power. The measurement is taken after equilibrium is reached. This method of measurement ensures that Luminus LEDs perform in the field just as they are specified.

Specification Measurement Condition (9A, 13.5 A)

The tables on the following pages provide typical optical and electrical characteristics measured at 9A for white, 13.5A for Green and Blue. The associated junction temperature is $T_j = 70$ °C for white and $T_j = 75$ ° - 90 ° C for GB. The CBT-90 can be operated over a wide range of current drive conditions from 200mA to 18A and duty cycle from <1% to 100%).

CBT-90 White Binning Structure

CBT-90 white LEDs are tested for luminous flux and chromaticity at a drive current of 9.0 A (1.0 A/mm²) and placed into one of the following luminous flux (FF) and chromaticity (WW) bins:

Flux Bins (At Test Condition *)

Color	Flux Bin (FF)	Minimum Flux (lm) at 9.0A	Maximum Flux (lm) at 9.0A
W57S (5700K) and W65S (6500K) 6500K, Standard CRI (typ. 70)	MA	1,380	1,485
	MB	1,485	1,590
	NA	1,590	1,710
	NB	1,710	1,830
	PA	1,830	1,966
	PB	1,966	2,100
W57H 5700K, High CRI (typ. 92) (Pending End of Life)	KA	1,080	1,120
	KB	1,120	1,200
	LA	1,200	1,290
	LB	1,290	1,380

*Note: Luminus maintains a +/- 6% tolerance on flux measurements.

Luminus maintains a +/- 2% tolerance on CRI measurements.

Chromaticity Bins

Luminus' Standard Chromaticity Bins: 1931 CIE Curve

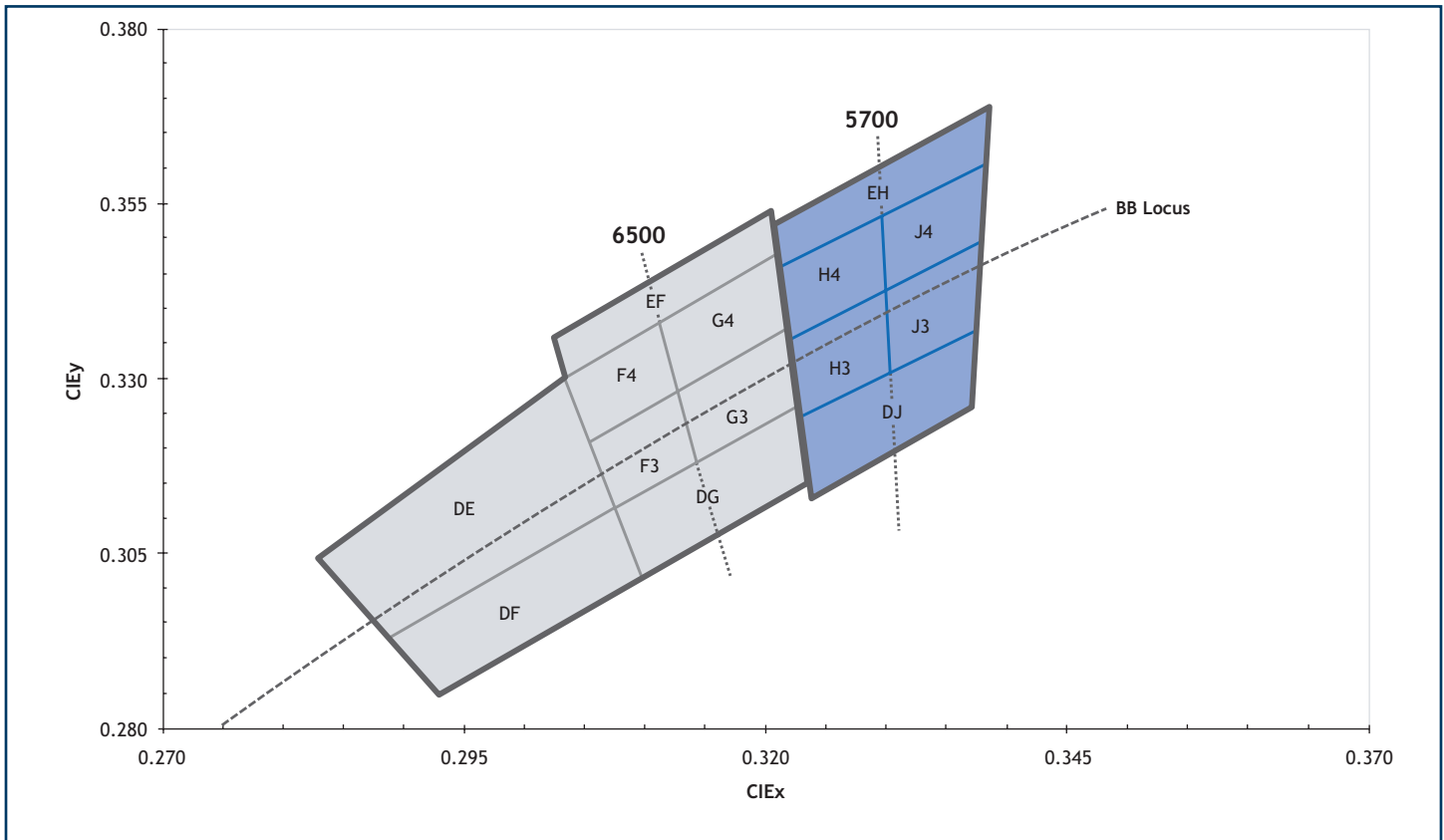

CBT-90 White Chromaticity Bins

The following tables describe the four chromaticity points that bound each chromaticity bin. Chromaticity bins are grouped together based on the color temperature.

6500K Chromaticity Bins		
Bin Code (WW)	CIEx	CIEy
DG	0.307	0.311
	0.322	0.326
	0.323	0.316
	0.309	0.302
F3*	0.305	0.321
	0.313	0.329
	0.315	0.319
	0.307	0.311
F4*	0.303	0.330
	0.312	0.339
	0.313	0.329
	0.305	0.321
G3*	0.313	0.329
	0.321	0.337
	0.322	0.326
	0.315	0.319
G4*	0.312	0.339
	0.321	0.348
	0.321	0.337
	0.313	0.329
EF	0.302	0.335
	0.320	0.354
	0.321	0.348
	0.303	0.330
DE	0.283	0.304
	0.303	0.330
	0.307	0.311
	0.289	0.293
DF	0.289	0.293
	0.307	0.311
	0.309	0.302
	0.293	0.285

5700K Chromaticity Bins		
Bin Code (WW)	CIEx	CIEy
DJ	0.322	0.324
	0.337	0.337
	0.336	0.326
	0.323	0.314
	0.321	0.335
H3*	0.329	0.342
	0.329	0.331
	0.322	0.324
	0.321	0.346
H4*	0.329	0.354
	0.329	0.342
	0.321	0.335
	0.329	0.342
J3*	0.329	0.342
	0.337	0.349
	0.337	0.337
	0.330	0.331
J4*	0.329	0.354
	0.338	0.362
	0.337	0.349
	0.329	0.342
EH	0.320	0.352
	0.338	0.368
	0.338	0.362
	0.321	0.346

*Sub-bins within ANSI defined quadrangles per ANSI C78.377-2008

CBT-90 Green/Blue Bin Structure

CBT-90 G/B: Not recommended for new designs. Please consider CBT-90 TE version instead as documented in PDS-002547 datasheet

All CBT-90 monochromatic LEDs are tested for luminous flux/ dominant wavelength and placed into one of the following flux/ wave length bins. The binning structure is universally applied across each monochromatic color of the CBT-90 product line. Consult the local sales person for the available flux/ wavelength bins for the product:

Flux Bins (At Test Condition*)

Color	Luminous Flux Bin (FF)	Minumum Flux (lm) @ 13.5A	Maximum Flux (lm) @ 13.5A
Green	CK	1,500	2,000
	CM	2,000	2,300
Blue	DJ	250	350
	DK	350	450
	DM	450	575

Dominant Wavelength Bins

Color	Wavelength Bin (FF)	Minumum Wavelength @ 13.5A	Maximum Wavelength @ 13.5A
Green	G4	520	525
	G5	525	530
	G6	530	535
	G7	535	540
Blue	B4	450	455
	B5	455	460
	B6	460	465
	B7	465	470

*Note: Luminus maintains a +/- 6% tolerance on flux measurements.

Product Shipping & Labeling Information

All CBT-90 products are packaged and labeled with their respective bin as outlined in the tables and charts on pages 3, 4, & 5. When shipped, each package will only contain one bin. The part number designation is as follows:

CBT-90 White

CBT — **90** — **WNNX** — **C11** — **FF** — **WW**

Product Family	Chip Area	Color	Package Configuration	Flux Bin	Chromaticity Bin
CBT: Chip on Board (window)	90: 9.0 mm ²	CCT & CRI See Note 1 below	Internal Code	See page 3 for bins	See page 4 for bins

Note 1: *WNNX nomenclature corresponds to the following:*

W = White

NN = color temperature, where:

57 corresponds to 5700K

65 corresponds to 6500K

X = color rendering index, where:

S (standard) corresponds to a typical CRI of 70

H (High) corresponds to a typical CRI of 92

Example 1:

The part label CBT-90-W65S-C11-NA-G4 refers to a 6500K standard CRI white, CBT-90 emitter, with a flux range from 1,590 to 1,710 lumens and a

CBT-90 Green/Blue²

CBT-90 G/B: Not recommended for new designs. Please consider CBT-90 TE version instead as documented in PDS-002547 datasheet

CBT — **90** — **X** — **C11** — **FF** — **WW**

Product Family	Chip Area	Color	Package Configuration	Flux Bin	Wavelength Bin
CBT: Chip on Board (window)	90: 9.0 mm ²	G: Green B: Blue	Internal Code	See page 5 for bins	See page 5 for bins

Note 2: *X nomenclature corresponds to the following:*

G = Green

B = Blue

Example 2:

The part number CBT-90-B-C11-DK-B6 refers to a blue, CBT-90 module, with a flux range 350-400 lumens and a wavelength range 460 nm to 465 nm.

CBT-90 White Electrical Characteristics¹
Optical and Electrical Characteristics

Drive Condition ²		9.0 A Continuous	
Parameter	Symbol	Values at Test Currents	Unit
Current Density	j	1.0	A/mm ²
Forward Voltage	V _{F,min}	2.9	V
	V _{F,typ}	3.3	V
	V _{F,max}	3.8	V

Common Characteristics

Parameter	Symbol	Values	Unit
Emitting Area		9.0	mm ²
Emitting Area Dimensions		3 x 3	mm×mm
Color Temperature ³ (typ)	CCT	5,700/6,500	K
Color Rendering Index ⁴ (Typical)	R _a	72	
Forward Voltage Temperature Coefficient ⁵		-5.47	mV/°C

Absolute Maximum Ratings

Parameter	Symbol	Values	Unit
Absolute Minimum Operating Current		0.2	A
Maximum Current ⁶		18	A
Maximum Junction Temperature ⁷	T _{j-max}	150	°C
Storage Temperature Range		-40/+100	°C

Note 1: All measured values are with a constant heat sink temperature $T_{heat\ sinks} = 40^{\circ}C$.

Note 2: CBT-90 white devices can be driven at currents ranging from 1A to 18A and at duty cycles ranging from 1% to 100%. Drive current and duty cycle should be adjusted as necessary to maintain the junction temperature desired to meet application lifetime requirements. In pulsed operation, rise time from 10-90% of forward current should be larger than 0.5 microseconds

Note 3: CCT value based off of CIE measurement. CIE measurement uncertainty for white devices is estimated to be +/- 0.01.

Note 4: Color Rendering Index (CRI) is measured to within + or - 2.

Note 5: Forward voltage temperature coefficient at current density of 1.0 A/mm². Contact Luminus for value at other drive conditions.

Note 6: CBT-90 White LEDs are designed for operation to an absolute maximum forward drive current density of 2.0 A/mm². Product lifetime data is specified at recommended forward drive currents.

Note 7: Lifetime dependent on LED junction temperature. Input power and thermal system must be properly managed to ensure lifetime. See charts on pg 8 for further information.

Note 8: Special design considerations must be observed for operation under 1 A. Please contact Luminus for further information.

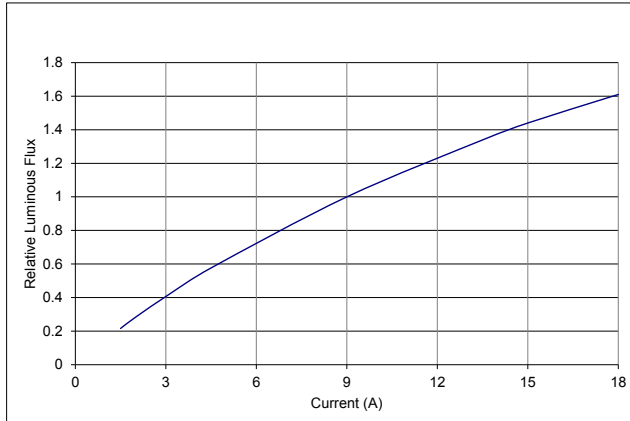
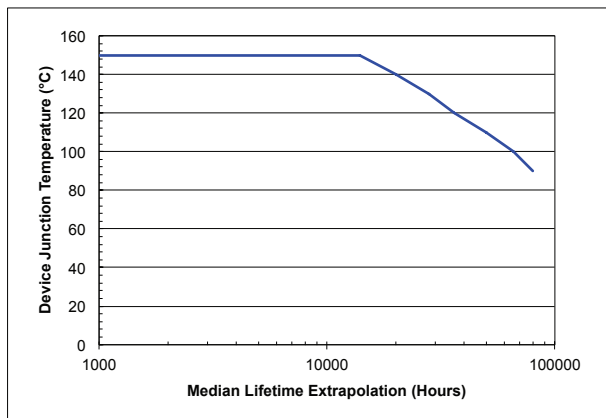
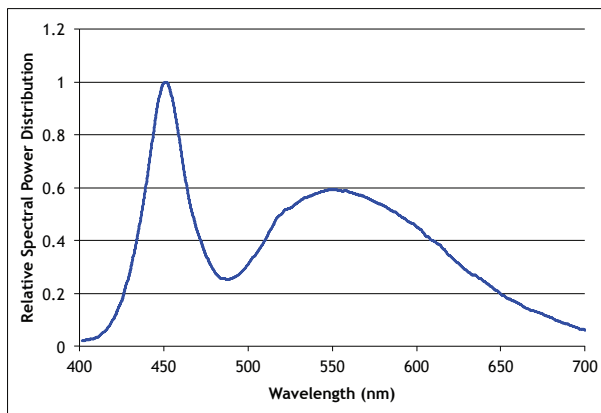
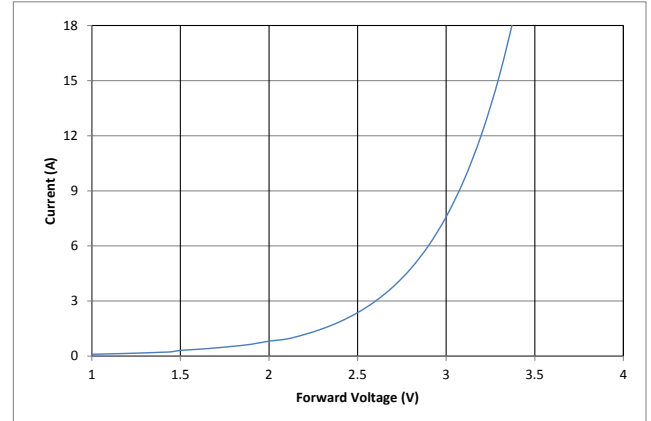
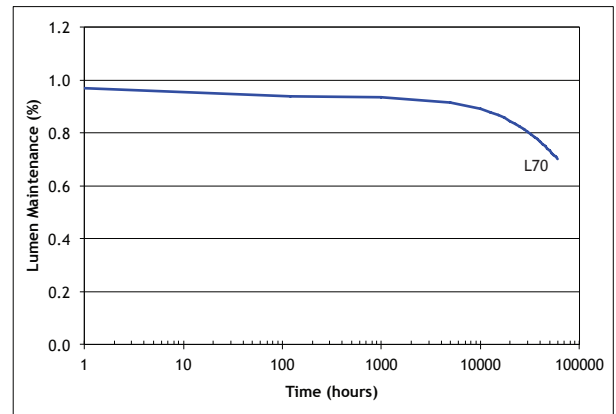
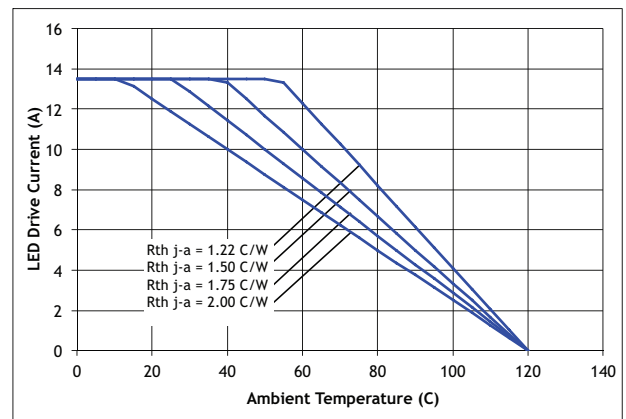
CBT-90 White Optical & Electrical Characteristics
Relative Output Flux vs. Forward Current

Mean Lifetime¹

Typical Spectrum³

Forward Current vs. Forward Voltage

Lumen Maintenance vs. Time²

Current Derating Curve

Note 1: Mean expected lifetime in dependence of junction temperature at 1.0 A/mm² in continuous operation. Lifetime defined as time to 70% of initial intensity. Based on lifetime test data. Data can be used to model failure rate over typical product lifetime (contact Luminus for lifetime reliability test data for 1A/mm² condition).

Note 2: Lumen maintenance in dependence of time at 1.0 A/mm² in continuous operation with junction temperatures of 130 °C.

Note 3: Typical spectrum at current density of 1.0 A/mm² in continuous operation.

CBT-90 Green/Blue Optical & Electrical Characteristics
CBT-90 G/B: Not recommended for new designs. Please consider CBT-90 TE version instead as documented in PDS-002547 datasheet

Green			
Drive Condition ^(1,2)		13.5 A Continuous	
Parameter	Symbol	Values ⁴	Unit
Current Density	J	1.5	A/mm ²
Forward Voltage	V _F min	3.2	V
	V _f	4.2	V
	V _F max	5.2	V
Luminous Flux ³	Φ _v	2,150	lm
Radiometric Flux	Φ _r	4.2	W
Luminous Efficacy	η	38	lm/W
Dominant Wavelength ⁴	λ _d	530	nm
Peak Wavelength	λ _p	523	nm
FWHM	Δλ _{1/2}	36	nm
Chromaticity Coordinates ⁵	x	0.192	-
	y	0.700	-

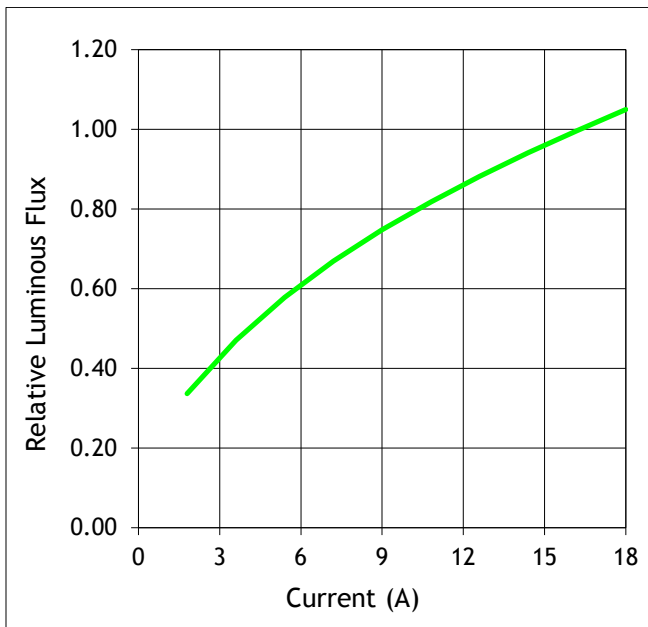
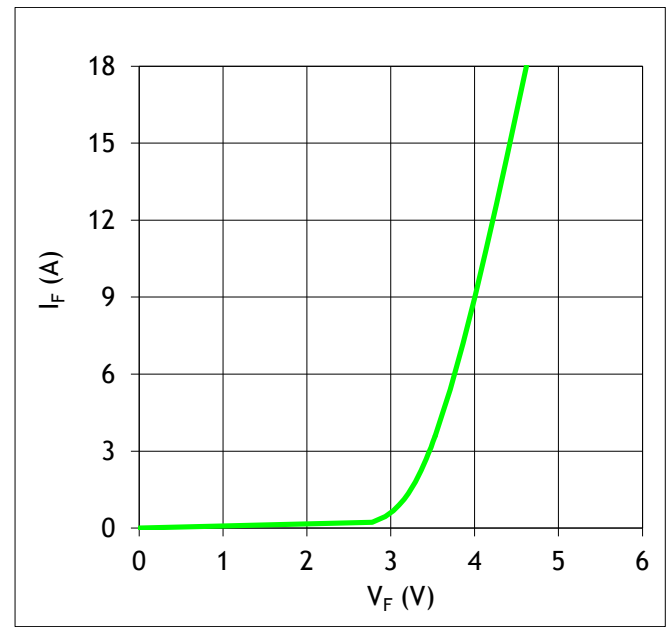
Relative Output Flux vs. Forward Current¹

Forward Current vs. Forward Voltage

Notes: See page 12

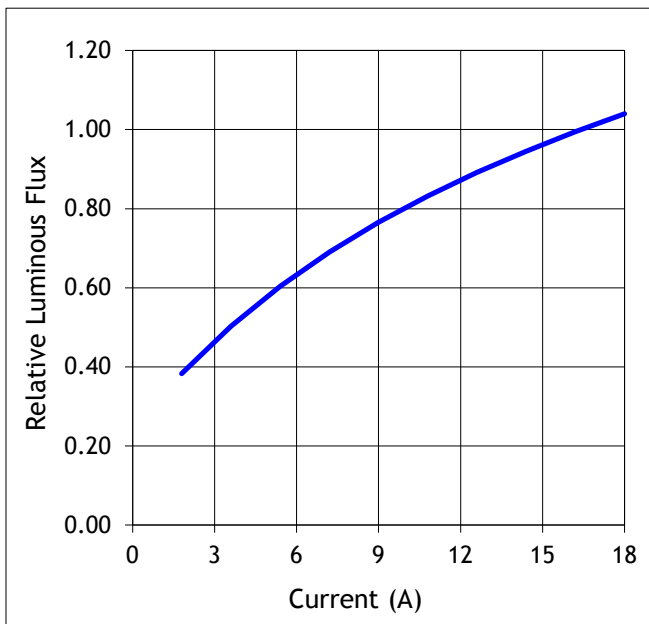
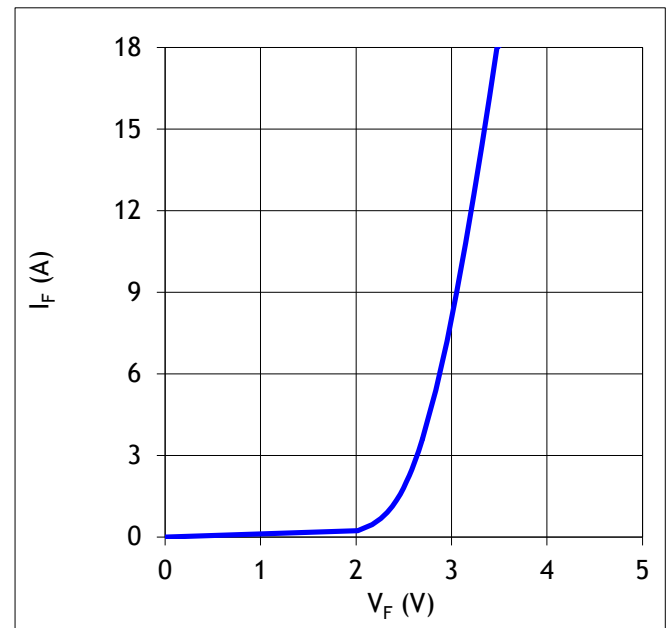
CBT-90 Green/Blue Optical & Electrical Characteristics

Blue			
Drive Condition ^(1,2)		13.5 A Continuous	
Parameter	Symbol	Values ⁴	Unit
Current Density	J	1.5	A/mm ²
Forward Voltage	V_{Fmin}	2.8	V
	V_f	3.4	V
	V_{Fmax}	4.0	V
Luminous Flux ³	Φ_{Vtyp}	425	lm
Radiometric Flux	Φ_r	9.5	W
Luminous Efficacy	η	10	lm/W
Dominant Wavelength ⁴	λ_d	460	nm
Peak Wavelength	λ_p	455	nm
FWHM	$\Delta\lambda_{1/2}$	20	nm
Chromaticity Coordinates ⁵	x	0.144	-
	y	0.038	-

Relative Output Flux vs. Forward Current¹

Forward Current vs. Forward Voltage

Notes: See page 12

CBT-90 Green/Blue Reference Optical & Electrical Characteristics
Common Characteristics

	Symbol	Green	Blue	Unit
Emitting Area		9.0	9.0	mm ²
Emitting Area Dimensions		3.0x3.0	3.0x3.0	mmxmm
Thermal Coefficient of Photometric Flux		-0.18	-0.007	%/ °C
Thermal Coefficient of Radiometric Flux		-0.20	-0.17	%/ °C
Thermal Coefficient of Junction Voltage ⁶		-4.6	-3.5	mV/ °C

	Symbol	Green	Blue	Unit
Absolute Minimum Operating Current		0.2	0.2	A
Maximum Current		18	18	A
Maximum Junction Temperature ^{7,8}	T _{jmax}	150	150	°C
Storage Temperature Range		-40/+100	-40/+100	°C

Note 1: All ratings are based on operation with a constant $T_{heat\ sink} = 40^{\circ}C$.

Note 2: CBT-90 RGB devices can be driven at currents ranging from 200mA to 18 A and at duty cycles ranging from 1% to 100%. Drive current and duty cycle should be adjusted as necessary to maintain the junction temperature desired to meet application lifetime requirements.

Note 3: Total flux from emitting area at listed dominant wavelength.

Note 4: Minimum and Maximum Dominant Wavelengths are based on typical values +/- 5nm for Red, +/- 8nm for Green and +/- 6nm for Blue.

Note 5: For reference only.

Note 6: Forward voltage temperature coefficient at current density of 1.0 A/mm². Contact Luminus for value at other drive conditions.

Note 7: CBT-90 G,B LEDs are designed for operation to an absolute maximum current as specified above. Product lifetime data is specified at recommended forward drive currents. Sustained operation at or beyond absolute maximum currents will result in a reduction of device lifetime compared to recommended forward drive currents. Actual device lifetimes will also depend on junction temperature. Refer to the lifetime derating curves for further information. In pulsed operation, rise time from 10-90% of forward current should be larger than 0.5 microseconds.

Note 8: Lifetime dependent on LED junction temperature. Input power and thermal system must be properly managed to ensure lifetime. See charts on pg 13 for further information.

Note 9: Special design considerations must be observed for operation under 1 A. Please contact Luminus for further information.

Note 10: Caution must be taken not to stare at the light emitted from these LEDs. Under special circumstances, the high intensity could damage the eye.

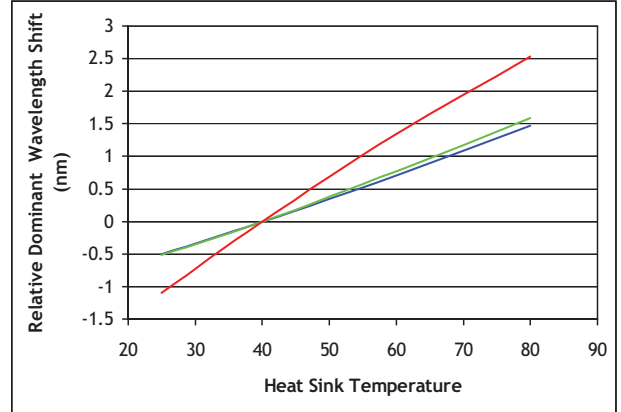
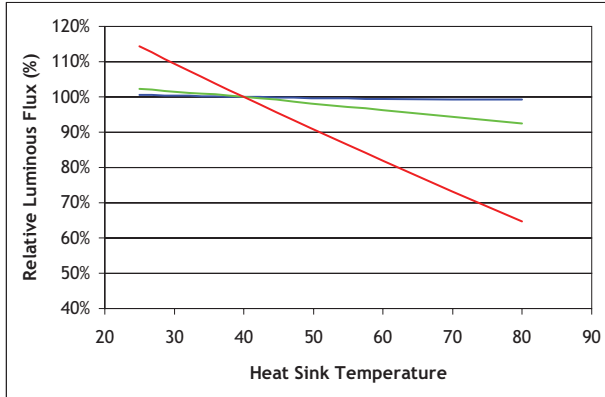
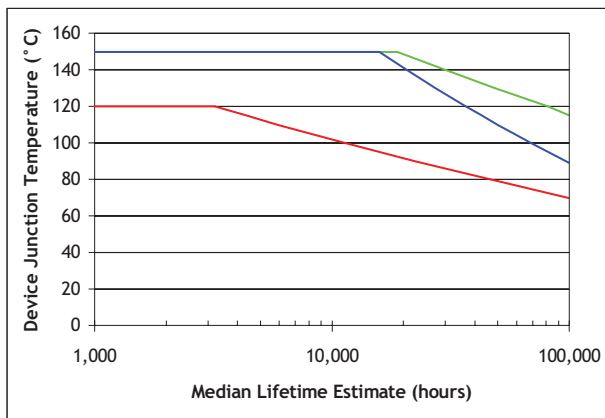
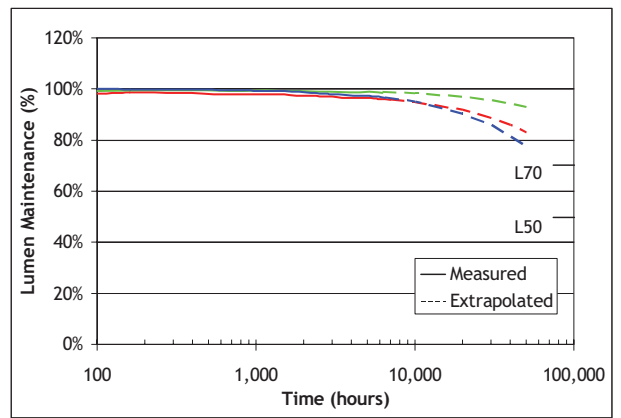
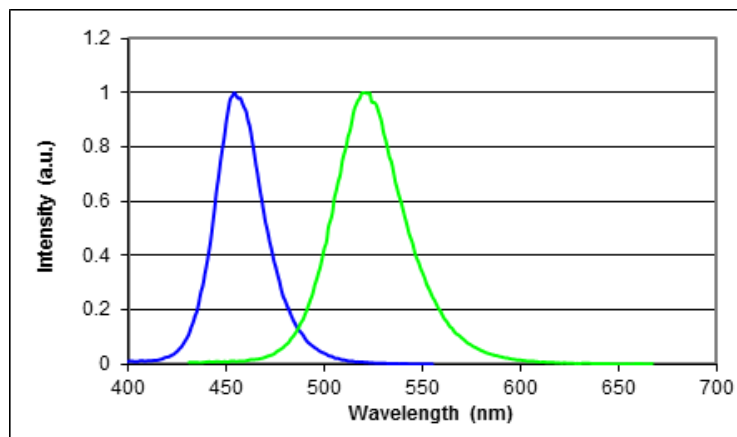
CBT-90 Green/Blue Lifetime and Lumen Maintenance
Light Output and Spectral Characteristics Over Heat Sink Temperature

Median Lifetime Estimate vs. T_j¹

Lumen Maintenance²

Typical Spectrum³

Note 1: Median lifetime estimate as a function of junction temperature at 0.35A/mm² in continuous operation. Lifetime defined as time to 70% of initial intensity. Based on preliminary lifetime test data. Data can be used to model failure rate over typical product lifetime.

Note 2: Lumen maintenance vs. time at 0.35A/mm² in continuous operation, Red junction temperature of 70°C, Green junction temperatures of 120°C, Blue junction temperatures of 100°C.

Note 3: Typical spectrum at current density of 0.35 A/mm² in continuous operation.

Typical Radiation Patterns

Typical Polar Radiation Pattern for White, Green and Blue

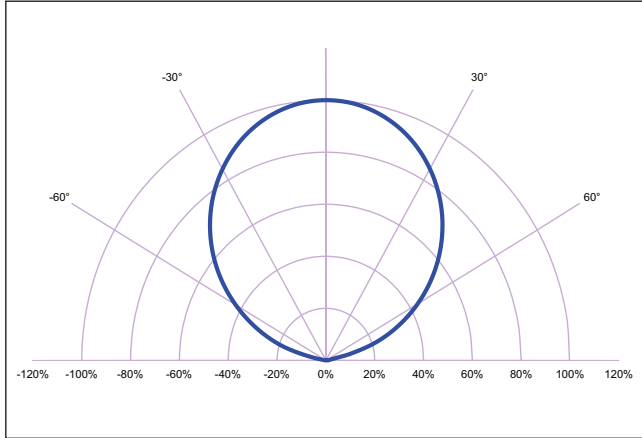

Typical Angular Radiation Pattern for White, Green and Blue

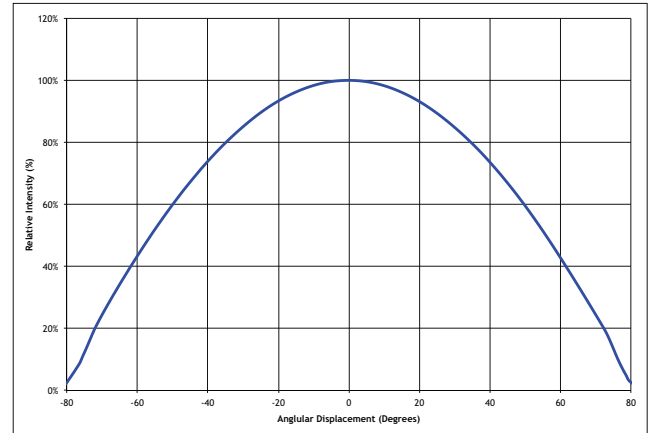

Thermal Resistance

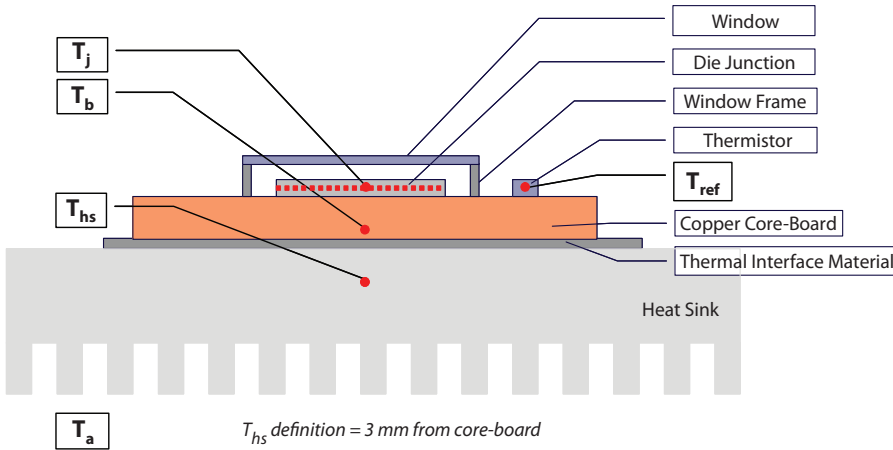

Typical Thermal Resistance

$R_{\theta j-b}^{-1}$	0.80 °C/W
$R_{\theta b-hs}^{-1}$	0.12 °C/W
$R_{\theta j-hs}^{-2}$	0.92 °C/W
$R_{\theta j-ref}^{-1}$	0.83 °C/W

Note 1: Thermal resistance values are based on FEA model results correlated to measured $R_{\theta j-hs}$ data.

Note 2: Thermal resistance is measured using eGraf 1205 thermal interface material.

Thermistor Information

The thermistor used in CBT-90 LEDs mounted on core-boards is from Murata Manufacturing Co. The global part number is NCP18XH103J03RB. Please see <http://www.murata.com/> for details on calculating thermistor temperature.

Electrical Pinout

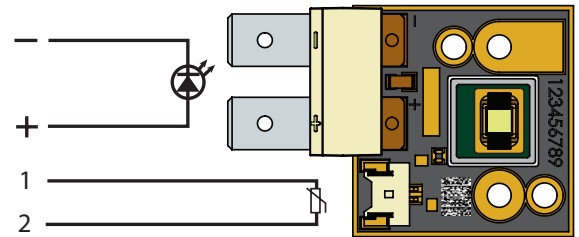

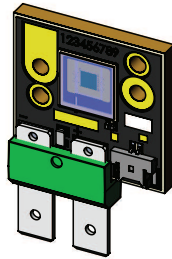
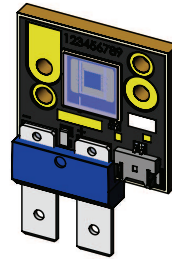
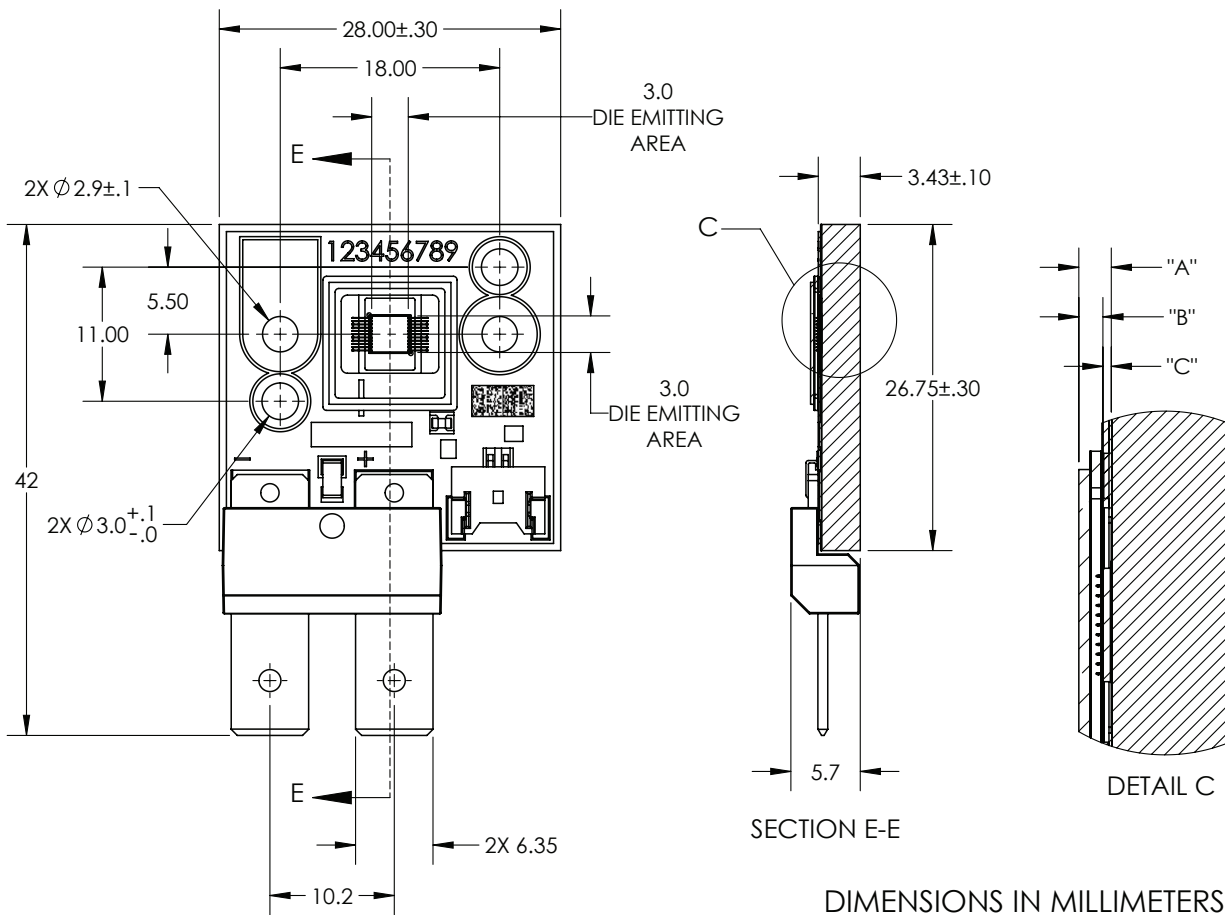
Mechanical Dimensions – CBT-90 Emitter

GREEN LED DEVICE

BLUE LED DEVICE

DIMENSIONS IN MILLIMETERS

DIMENSION NAME	DESCRIPTION	NOMINAL DIMENSION	TOLERANCE
"A"	TOP OF METAL SUBSTRATE TO TOP OF WINDOW	.88	$\pm .13$
"B"	TOP OF DIE EMITTING AREA TO TOP OF WINDOW	.65	$\pm .11$
"C"	TOP OF METAL SUBSTRATE TO TOP OF DIE EMITTING AREA	.23	$\pm .02$

DWG-002309

Recommended connectors for Anode and Cathode:

- Panduit Disco Lok™ Series P/N: DNF14-250FIB-C
- JST Manufacturing Co: SPS-61T-250

 Thermistor Connector: MOLEX P/N 53780-0270 or GCT P/N WTB08-0215-F.
 Recommended Female: MOLEX P/N 51146-0200, GCT P/N WTB06-0215-F or equivalent

Ordering Information

Ordering Part Number ^{1,2}	Color	Description
CBT-90-W57S-C11-NA100	5700K White	White LED™ CBT-90 consisting of a 9 mm ² LED, thermistor, and connector, mounted on a copper-core PCB
CBT-90-W65S-C11-NA100	6500K White	
CBT-90-W57H-C11-KB200 (Pending EOL)	5700K White High CRI	
CBT-90-G-C11-JK200	Green	Green LED™ CBT-90 consisting of 9 mm ² LED, thermistor, and connector, mounted on a copper-core PCB. CBT-90 G : Product Discontinued. Please consider CBT-90 TE version instead as documented in PDS-002547 datasheet.
CBT-90-B-C11-KJ300	Blue	Blue LED™ CBT-90 consisting of 9 mm ² LED, thermistor, and connector, mounted on a copper-core PCB. CBT-90 B : Product Discontinued. Please consider CBT-90 TE version instead as documented in PDS-002547 datasheet.

Note 1: NA100 - denotes a bin kit comprising of all flux bins with a minimum flux of 1,590 lumens and chromaticity bins at the 6500K color point.

Note 2: KB200 - denotes a bin kit comprising of all flux bins with a minimum flux of 1,120 lumens and chromaticity bins at the 5700K color point.

Note 3: JK200 - denotes a bin kit comprising of all green flux and wavelength bins as specified on page 5

KJ300 - denotes a bin kit comprising of all blue flux and wavelength bins as specified on page 5.

Note 4: For ordering information on all available bin kits, please reference PDS-001694: CBT-90 Binning & Labeling document.

Note 5: Standard packaging increment (SPI) is 10.

Note 6: Red CBT-90 has been discontinued - please refer to PDS-002547 (CBT-90 Thermally Enhanced version) for information on current red product offering

Green- C11 product has been moved to EOL Status - Please consider use of Thermally enhanced version for new design applications.

History of Changes

Rev	Date	Description of Change
14	09/27/2016	Clarified applicable minimum operating current
		Editorial Changes
		<i>CBT-90 G/B product discontinued .Please consider CBT-90 TE version instead as documented in PDS-002547 datasheet</i>
		Updated thermistor connector information
		Adding 5700K

The products, their specifications and other information appearing in this document are subject to change by Luminus Devices without notice. Luminus Devices assumes no liability for errors that may appear in this document, and no liability otherwise arising from the application or use of the product or information contained herein. None of the information provided herein should be considered to be a representation of the fitness or suitability of the product for any particular application or as any other form of warranty. Luminus Devices' product warranties are limited to only such warranties as accompany a purchase contract or purchase order for such products. Nothing herein is to be construed as constituting an additional warranty. No information contained in this publication may be considered as a waiver by Luminus Devices of any intellectual property rights that Luminus Devices may have in such information. LEDs™ is a registered trademark of Luminus Devices, Inc., all rights reserved.

This product is protected by U.S. Patents 6,831,302; 7,074,631; 7,083,993; 7,084,434; 7,098,589; 7,105,861; 7,138,666; 7,166,870; 7,166,871; 7,170,100; 7,196,354; 7,211,831; 7,262,550; 7,274,043; 7,301,271; 7,341,880; 7,344,903; 7,345,416; 7,348,603; 7,388,233; 7,391,059 Patents Pending in the U.S. and other countries.