



Chipsmall Limited consists of a professional team with an average of over 10 year of expertise in the distribution of electronic components. Based in Hongkong, we have already established firm and mutual-benefit business relationships with customers from,Europe,America and south Asia,supplying obsolete and hard-to-find components to meet their specific needs.

With the principle of “Quality Parts,Customers Priority,Honest Operation,and Considerate Service”,our business mainly focus on the distribution of electronic components. Line cards we deal with include Microchip,ALPS,ROHM,Xilinx,Pulse,ON,Everlight and Freescale. Main products comprise IC,Modules,Potentiometer,IC Socket,Relay,Connector.Our parts cover such applications as commercial,industrial, and automotives areas.

We are looking forward to setting up business relationship with you and hope to provide you with the best service and solution. Let us make a better world for our industry!



Contact us

Tel: +86-755-8981 8866 Fax: +86-755-8427 6832

Email & Skype: info@chipsmall.com Web: www.chipsmall.com

Address: A1208, Overseas Decoration Building, #122 Zhenhua RD., Futian, Shenzhen, China



Important notice

Dear Customer,

On 7 February 2017 the former NXP Standard Product business became a new company with the tradename **Nexperia**. Nexperia is an industry leading supplier of Discrete, Logic and PowerMOS semiconductors with its focus on the automotive, industrial, computing, consumer and wearable application markets

In data sheets and application notes which still contain NXP or Philips Semiconductors references, use the references to Nexperia, as shown below.

Instead of <http://www.nxp.com>, <http://www.philips.com/> or <http://www.semiconductors.philips.com/>, use <http://www.nexperia.com>

Instead of sales.addresses@www.nxp.com or sales.addresses@www.semiconductors.philips.com, use salesaddresses@nexperia.com (email)

Replace the copyright notice at the bottom of each page or elsewhere in the document, depending on the version, as shown below:

- © NXP N.V. (year). All rights reserved or © Koninklijke Philips Electronics N.V. (year). All rights reserved

Should be replaced with:

- © **Nexperia B.V. (year). All rights reserved.**

If you have any questions related to the data sheet, please contact our nearest sales office via e-mail or telephone (details via salesaddresses@nexperia.com). Thank you for your cooperation and understanding,

Kind regards,

Team Nexperia

DATA SHEET

CBTD16210

20-bit level shifting bus switch
with 10-bit output enables

Product specification
Supersedes data of 2000 Sep 25

2000 Oct 12

20-bit level shifting bus switch with 10-bit output enables

CBTD16210

FEATURES

- 5Ω switch connection between two ports
- TTL compatible control input levels
- Designed to be used in 5.5 V to 3.3 V level shifting applications
- Package options include shrink small outline (SSOP) and thin shrink small outline (TSSOP)

DESCRIPTION

The CBTD16210 provides 20 bits of high-speed TTL-compatible bus switching. The low on-state resistance of the switch allows connections to be made with minimal propagation delay.

A diode to V_{CC} is integrated in the circuit to allow for level shifting between 5 V inputs and 3.3 V outputs.

The device is organized as a dual 10-bit bus switch with separate output-enable (\overline{OE}) inputs. It can be used as two 10-bit bus switches or as one 20-bit bus switch. When \overline{OE} is low, the associated 10-bit bus switch is on, and port A is connected to port B. When \overline{OE} is high, the switch is open, and a high-impedance state exists between the ports.

The CBTD16210 is characterized for operation from -40°C to $+85^{\circ}\text{C}$.

QUICK REFERENCE DATA

SYMBOL	PARAMETER	CONDITIONS $T_{amb} = 25^{\circ}\text{C}; \text{GND} = 0\text{V}$	TYPICAL	UNIT
t_{PLH} t_{PHL}	Propagation delay An to Yn	$C_L = 50\text{pF}; V_{CC} = 5\text{V}$	0.25	ns
C_{IN}	Input capacitance	$V_I = 0\text{V}$ or V_{CC}	4.3	pF
C_{OUT}	Output capacitance	Outputs disabled; $V_O = 0\text{V}$ or V_{CC}	6.9	pF
I_{CCZ}	Total supply current	Outputs disabled; $V_{CC} = 5.5\text{V}$	4.0	μA

ORDERING INFORMATION

PACKAGES	TEMPERATURE RANGE	ORDER CODE	DWG NUMBER
48-Pin Plastic SSOP Type III	-40°C to $+85^{\circ}\text{C}$	CBTD16210 DL	SOT370-1
48-Pin Plastic TSSOP Type II	-40°C to $+85^{\circ}\text{C}$	CBTD16210 DGG	SOT362-1

LOGIC SYMBOL

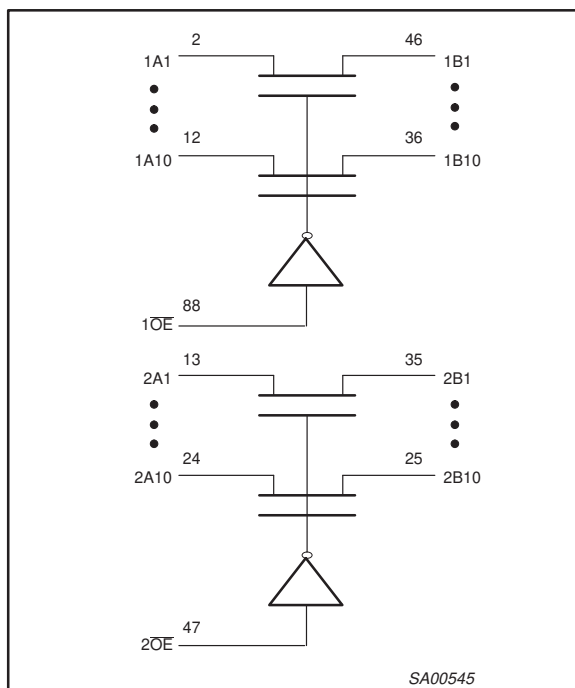

FUNCTION TABLE

INPUTS		OUTPUTS	
$1\overline{OE}$	$2\overline{OE}$	1A, 1B	2A, 2B
L	L	1A = 1B	2A = 2B
L	H	1A = 1B	Z
H	L	Z	2A = 2B
H	H	Z	Z

H = High voltage level
 L = Low voltage level
 Z = High impedance "off" state

20-bit level shifting bus switch with 10-bit output enables

CBTD16210

PIN CONFIGURATION

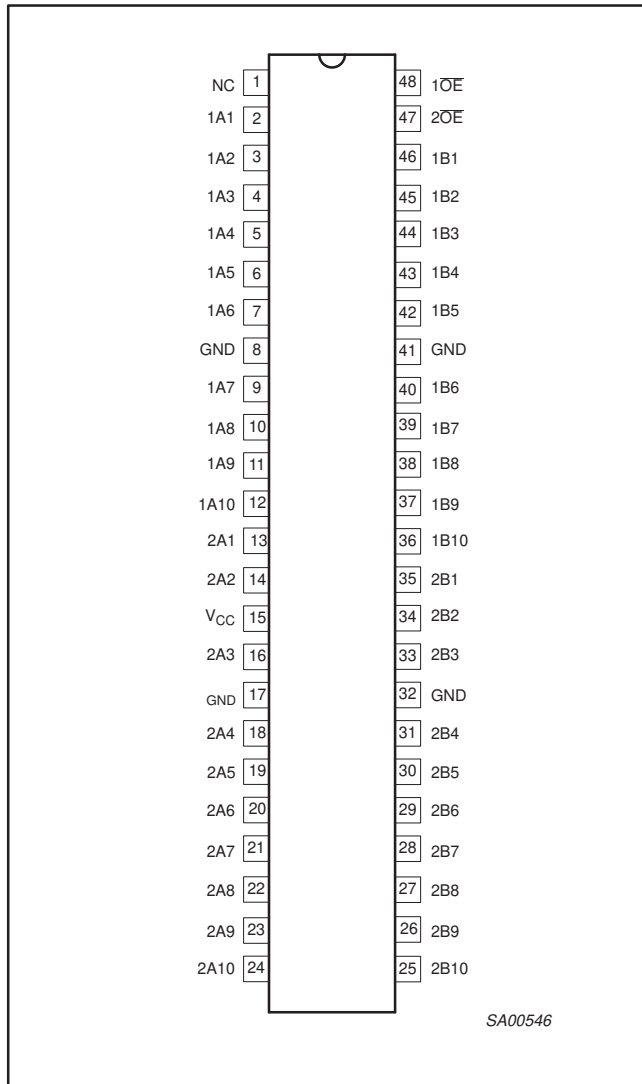

PIN DESCRIPTION

PIN NUMBER	SYMBOL	NAME AND FUNCTION
1	NC	No internal connection
48, 47	1OE, 2OE	Output enables
2, 3, 4, 5, 6, 7, 9, 10, 11, 12	1A1-1A10	Inputs
46, 45, 44, 43, 42, 40, 39, 38, 37, 36	1B1-1B10	Outputs
13, 14, 16, 18, 19, 20, 21, 22, 23, 24	2A1-2A10	Inputs
35, 34, 33, 31, 30, 29, 28, 27, 26, 25	2B1-2B10	Outputs
8, 17, 32, 41	GND	Ground (0V)
15	V _{CC}	Positive supply voltage

20-bit level shifting bus switch with 10-bit output enables

CBTD16210

ABSOLUTE MAXIMUM RATINGS^{1, 2}

SYMBOL	PARAMETER	CONDITIONS	RATING	UNIT
V_{CC}	DC supply voltage		-0.5 to +7.0	V
I_{IK}	DC input diode current	$V_I < 0$	-50	mA
V_I	DC input voltage ³		-0.5 to +7.0	V
V_{OUT}	DC output voltage ³	output in Off or High state	-0.5 to +5.5	V
I_{OUT}	DC output current	output in Low state	128	mA
T_{stg}	Storage temperature range		-65 to +150	°C

NOTES:

- Stresses beyond those listed may cause permanent damage to the device. These are stress ratings only and functional operation of the device at these or any other conditions beyond those indicated under "recommended operating conditions" is not implied. Exposure to absolute-maximum-rated conditions for extended periods may affect device reliability.
- The performance capability of a high-performance integrated circuit in conjunction with its thermal environment can create junction temperatures which are detrimental to reliability. The maximum junction temperature of this integrated circuit should not exceed 150°C.
- The input and output voltage ratings may be exceeded if the input and output current ratings are observed.

RECOMMENDED OPERATING CONDITIONS

SYMBOL	PARAMETER	LIMITS		UNIT
		Min	Max	
V_{CC}	DC supply voltage	4.5	5.5	V
V_{IH}	High-level input voltage	2.0		V
V_{IL}	Low-level Input voltage		0.8	V
T_{amb}	Operating free-air temperature range	-40	+85	°C

DC ELECTRICAL CHARACTERISTICS

SYMBOL	PARAMETER	TEST CONDITIONS	LIMITS			UNIT
			$T_{amb} = -40^{\circ}\text{C to } +85^{\circ}\text{C}$			
			Min	Typ ¹	Max	
V_{IK}	Input clamp voltage	$V_{CC} = 4.5\text{ V}; I_I = -18\text{ mA}$			-1.2	V
V_{OH}	Output high pass voltage	See Figure 1, page 6				V
I_I	Input leakage current	$V_{CC} = 0\text{ V}; V_I = 5.5\text{ V}$			10	μA
		$V_{CC} = 5.5\text{ V}; V_I = \text{GND or } 5.5\text{ V}$			± 1	
I_{CC}	Quiescent supply current ²	$V_{CC} = 5.5\text{ V}; I_O = 0, V_I = V_{CC}\text{ or GND}; 1OE=2OE=GND$			1.5	mA
ΔI_{CC}	Additional supply current per input pin ²	$V_{CC} = 5.5\text{ V}$, one input at 3.4 V, other inputs at V_{CC} or GND			2.5	mA
C_I	Control pins	$V_I = 3\text{ V or } 0$		4.5		pF
$C_{IO(OFF)}$	Power-off leakage current	$V_O = 3\text{ V or } 0, \overline{OE} = V_{CC}$		8		pF
r_{on}^3		$V_{CC} = 4.5\text{ V}; V_I = 0\text{ V}; I_I = 64\text{ mA}$		5	7	Ω
		$V_{CC} = 4.5\text{ V}; V_I = 0\text{ V}; I_I = 30\text{ mA}$		5	7	
		$V_{CC} = 4.5\text{ V}; V_I = 2.4\text{ V}; I_I = -15\text{ mA}$		16	50	

NOTES:

- All typical values are at $V_{CC} = 5\text{ V}$, $T_{amb} = 25^{\circ}\text{C}$
- This is the increase in supply current for each input that is at the specified TTL voltage level rather than V_{CC} or GND
- Measured by the voltage drop between the A and the B terminals at the indicated current through the switch. On-state resistance is determined by the lowest voltage of the two (A or B) terminals.

20-bit level shifting bus switch with 10-bit output enables

CBTD16210

AC CHARACTERISTICS

GND = 0 V; t_R ; $C_L = 50$ pF

SYMBOL	PARAMETER DESCRIPTION	LIMITS -40°C to +85°C $V_{CC} = 5 V \pm 0.5 V$			UNITS
		Min	Mean	Max	
t_{pd}	Propagation delay ¹			250	ps
t_{pZH}	Output enable time to HIGH level	1.5	5.0	7.5	ns
t_{pHZ}	Output disable time from HIGH level	1.0	2.5	4.5	ns
t_{pZL}	Output enable time to LOW level	1.5	6.0	9.0	ns
t_{pLZ}	Output disable time from LOW level	1.5	3.5	6.0	ns

NOTES:

1. This parameter is warranted but not production tested. The propagation delay is based on the RC time constant of the typical on-state resistance of the switch and a load capacitance of 50 pF, when driven by an ideal voltage source (zero output impedance).

AC WAVEFORMS

$V_M = 1.5 V$, $V_{IN} = GND$ to 3.0 V

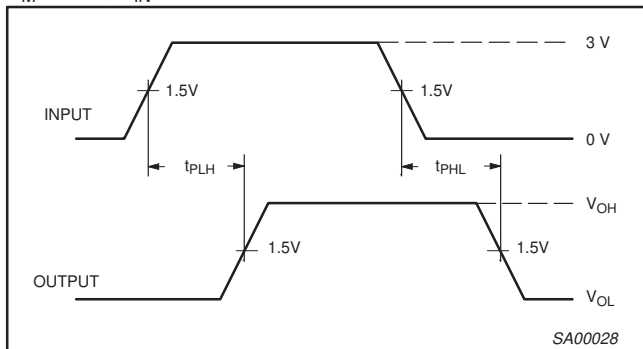

Waveform 1. Input (An) to Output (Yn) Propagation Delays

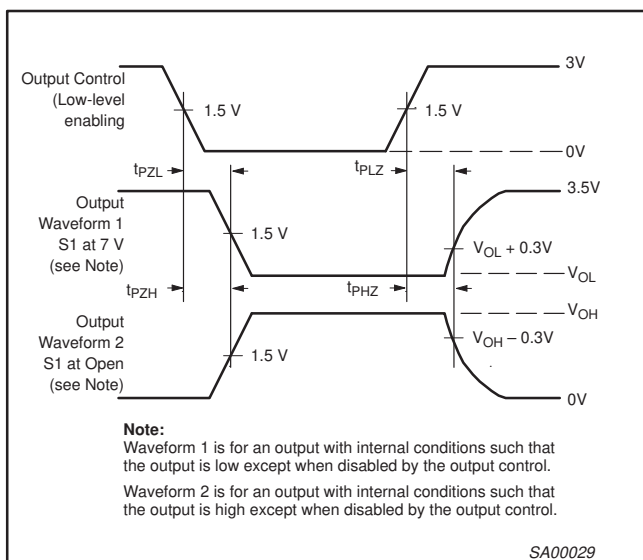

Waveform 2. 3-State Output Enable and Disable Times

TEST CIRCUIT AND WAVEFORMS

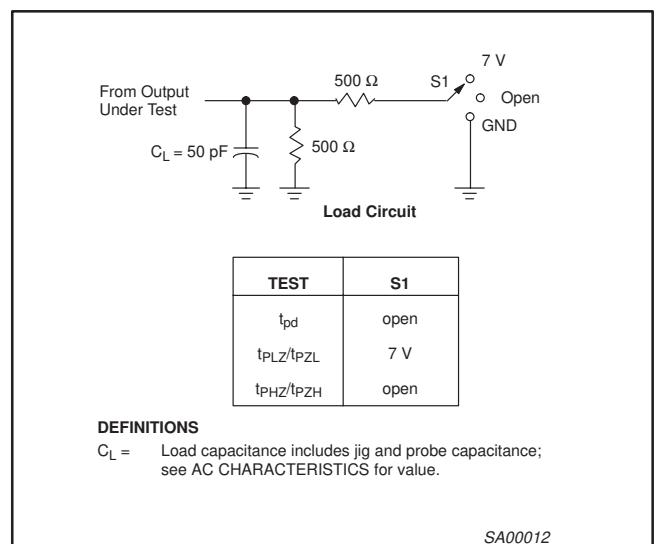

20-bit level shifting bus switch with 10-bit output enables

CBTD16210

TYPICAL CHARACTERISTICS

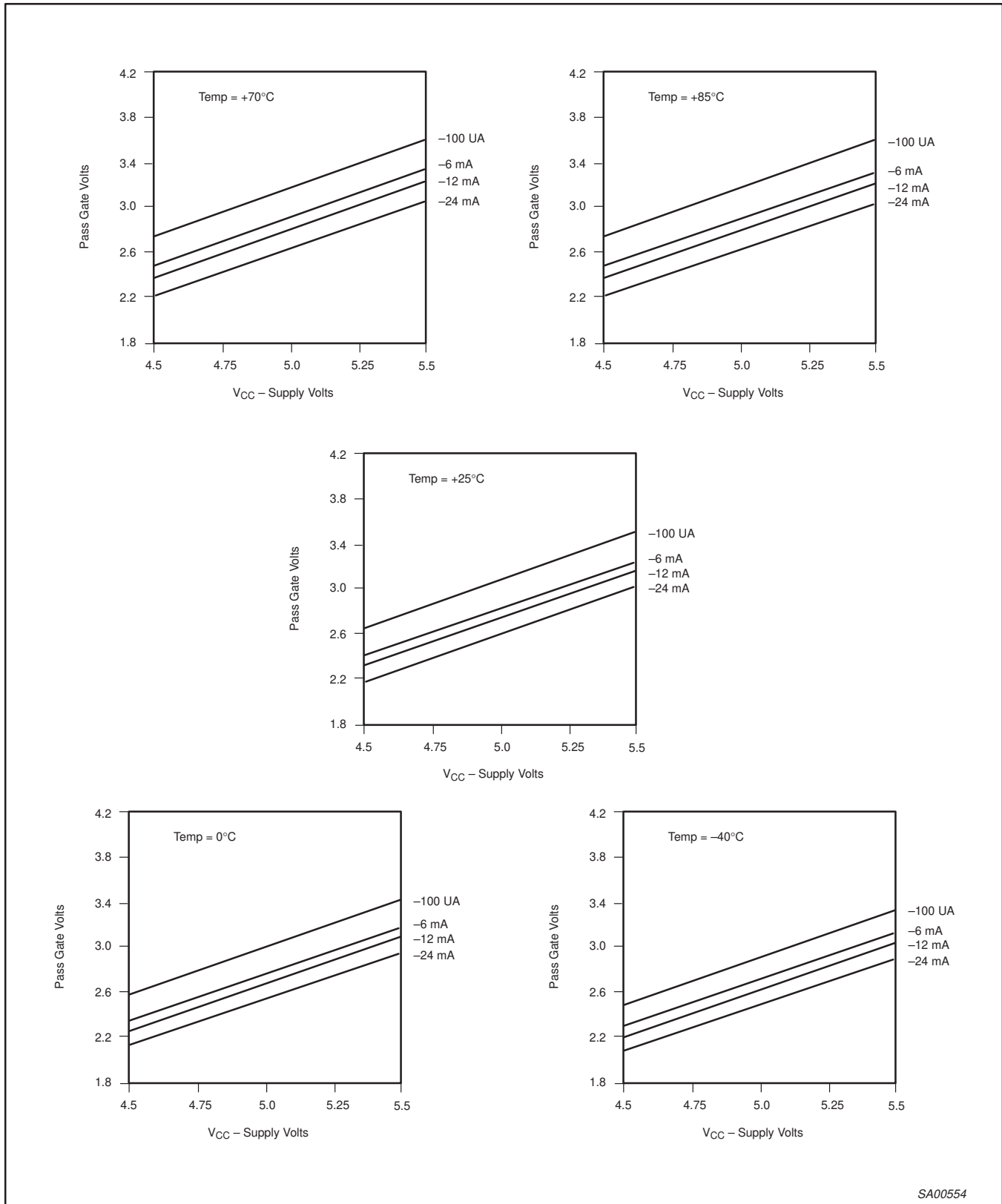

Figure 1. V_{OH} values (V_{in} = V_{CC})

SA00554

20-bit level shifting bus switch with 10-bit output enables

CBTD16210

SSOP48: plastic shrink small outline package; 48 leads; body width 7.5 mm

SOT370-1

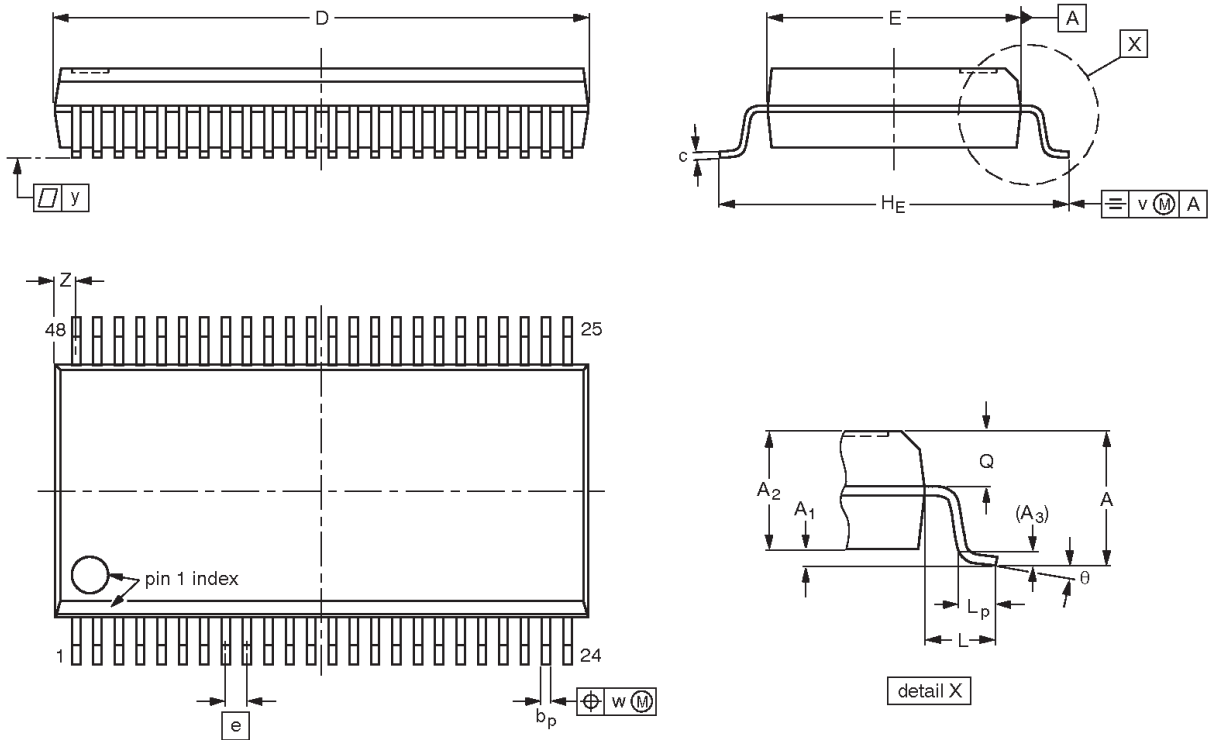

DIMENSIONS (mm are the original dimensions)

UNIT	A max.	A ₁	A ₂	A ₃	b _p	c	D ⁽¹⁾	E ⁽¹⁾	e	H _E	L	L _p	Q	v	w	y	Z ⁽¹⁾	θ
mm	2.8	0.4 0.2	2.35 2.20	0.25	0.3 0.2	0.22 0.13	16.00 15.75	7.6 7.4	0.635	10.4 10.1	1.4	1.0 0.6	1.2 1.0	0.25	0.18	0.1	0.85 0.40	8° 0°

Note

1. Plastic or metal protrusions of 0.25 mm maximum per side are not included.

OUTLINE VERSION	REFERENCES				EUROPEAN PROJECTION	ISSUE DATE
	IEC	JEDEC	EIAJ			
SOT370-1		MO-118				95-02-04 99-12-27

20-bit level shifting bus switch with 10-bit output enables

CBTD16210

TSSOP48: plastic thin shrink small outline package; 48 leads; body width 6.1 mm

SOT362-1

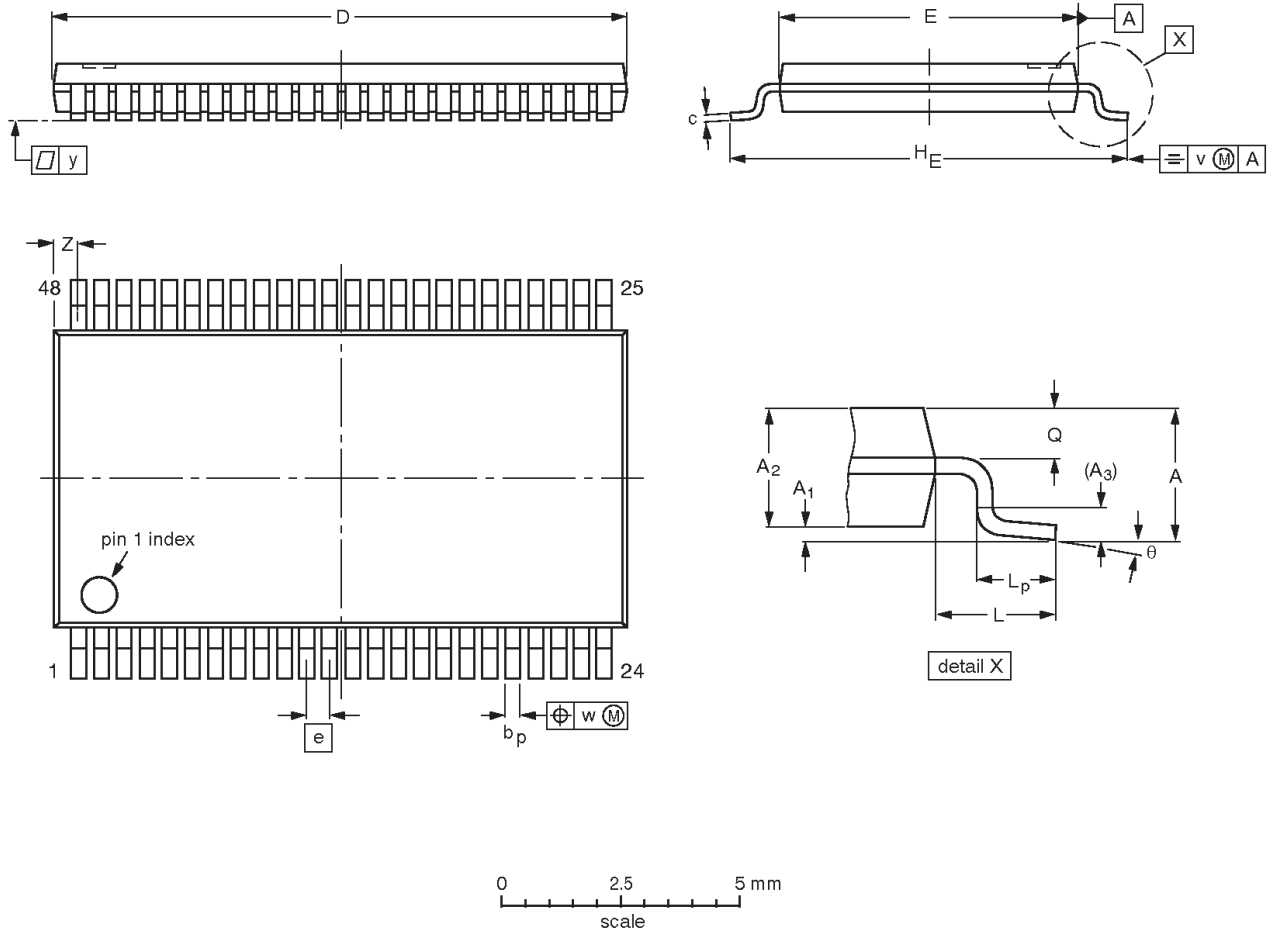

DIMENSIONS (mm are the original dimensions).

UNIT	A max.	A ₁	A ₂	A ₃	b _p	c	D ⁽¹⁾	E ⁽²⁾	e	H _E	L	L _p	Q	v	w	y	Z	θ
mm	1.2	0.15 0.05	1.05 0.85	0.25	0.28 0.17	0.2 0.1	12.6 12.4	6.2 6.0	0.5	8.3 7.9	1	0.8 0.4	0.50 0.35	0.25	0.08	0.1	0.8 0.4	8° 0°

Notes

1. Plastic or metal protrusions of 0.15 mm maximum per side are not included.
2. Plastic interlead protrusions of 0.25 mm maximum per side are not included.

OUTLINE VERSION	REFERENCES				EUROPEAN PROJECTION	ISSUE DATE
	IEC	JEDEC	EIAJ			
SOT362-1		MO-153				-95-02-10- 99-12-27

20-bit level shifting bus switch
with 10-bit output enables

CBTD16210

NOTES

20-bit level shifting bus switch with 10-bit output enables

CBTD16210

Data sheet status

Data sheet status	Product status	Definition [1]
Objective specification	Development	This data sheet contains the design target or goal specifications for product development. Specification may change in any manner without notice.
Preliminary specification	Qualification	This data sheet contains preliminary data, and supplementary data will be published at a later date. Philips Semiconductors reserves the right to make changes at any time without notice in order to improve design and supply the best possible product.
Product specification	Production	This data sheet contains final specifications. Philips Semiconductors reserves the right to make changes at any time without notice in order to improve design and supply the best possible product.

[1] Please consult the most recently issued datasheet before initiating or completing a design.

Definitions

Short-form specification — The data in a short-form specification is extracted from a full data sheet with the same type number and title. For detailed information see the relevant data sheet or data handbook.

Limiting values definition — Limiting values given are in accordance with the Absolute Maximum Rating System (IEC 134). Stress above one or more of the limiting values may cause permanent damage to the device. These are stress ratings only and operation of the device at these or at any other conditions above those given in the Characteristics sections of the specification is not implied. Exposure to limiting values for extended periods may affect device reliability.

Application information — Applications that are described herein for any of these products are for illustrative purposes only. Philips Semiconductors make no representation or warranty that such applications will be suitable for the specified use without further testing or modification.

Disclaimers

Life support — These products are not designed for use in life support appliances, devices or systems where malfunction of these products can reasonably be expected to result in personal injury. Philips Semiconductors customers using or selling these products for use in such applications do so at their own risk and agree to fully indemnify Philips Semiconductors for any damages resulting from such application.

Right to make changes — Philips Semiconductors reserves the right to make changes, without notice, in the products, including circuits, standard cells, and/or software, described or contained herein in order to improve design and/or performance. Philips Semiconductors assumes no responsibility or liability for the use of any of these products, conveys no license or title under any patent, copyright, or mask work right to these products, and makes no representations or warranties that these products are free from patent, copyright, or mask work right infringement, unless otherwise specified.

Philips Semiconductors
811 East Arques Avenue
P.O. Box 3409
Sunnyvale, California 94088-3409
Telephone 800-234-7381

© Copyright Philips Electronics North America Corporation 2000
All rights reserved. Printed in U.S.A.

Date of release: 10-00

Document order number:

9397 750 07692

Let's make things better.