



Chipsmall Limited consists of a professional team with an average of over 10 year of expertise in the distribution of electronic components. Based in Hongkong, we have already established firm and mutual-benefit business relationships with customers from,Europe,America and south Asia,supplying obsolete and hard-to-find components to meet their specific needs.

With the principle of “Quality Parts,Customers Priority,Honest Operation,and Considerate Service”,our business mainly focus on the distribution of electronic components. Line cards we deal with include Microchip,ALPS,ROHM,Xilinx,Pulse,ON,Everlight and Freescale. Main products comprise IC,Modules,Potentiometer,IC Socket,Relay,Connector.Our parts cover such applications as commercial,industrial, and automotives areas.

We are looking forward to setting up business relationship with you and hope to provide you with the best service and solution. Let us make a better world for our industry!



Contact us

Tel: +86-755-8981 8866 Fax: +86-755-8427 6832

Email & Skype: info@chipsmall.com Web: www.chipsmall.com

Address: A1208, Overseas Decoration Building, #122 Zhenhua RD., Futian, Shenzhen, China



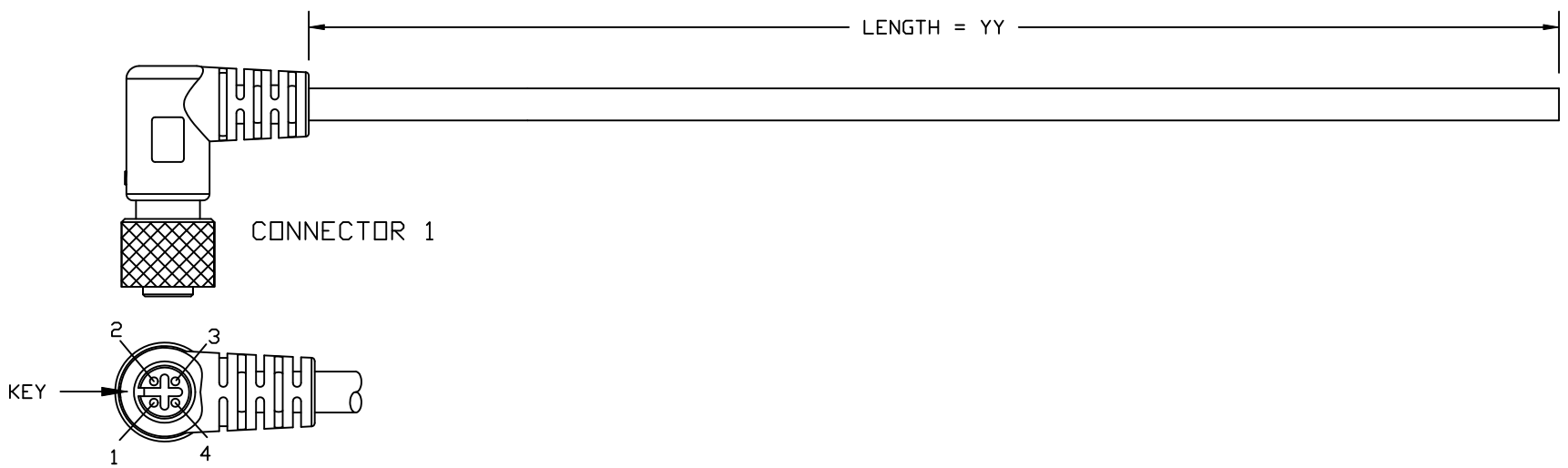

1. CONNECTOR 1 : 858-004-203RLS4, MOLDED RIGHT ANGLE HOOD, COLOR BLACK
2. WIRE : 24AWG, 4 TWISTED PAIRS, UL2835, FOIL SHIELD, COLOR BLACK, 30V
3. CABLE DIAMETER : 0.256 [6.50] ±0.007 [±0.19]
4. PIN OUT :

WIRING SCHEMATIC

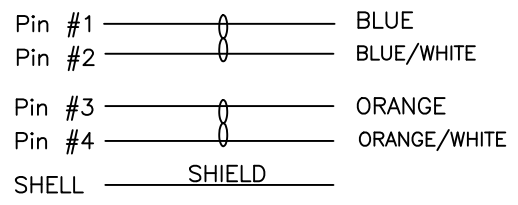

CCA-000-MYYR216

- 01 = 1 METER
- 02 = 2 METERS
- 03 = 3 METERS

**SEE PAGE 3 FOR CABLE SPECIFICATIONS

RoHS COMPLIANT

DO NOT SCALE FROM DRAWING



THESE DRAWINGS AND SPECIFICATIONS ARE THE PROPERTY OF NorComp AND SHALL NOT BE REPRODUCED, COPIED OR USED AS THE BASIS FOR THE MANUFACTURE OR SALE OF APPARATUS WITHOUT WRITTEN PERMISSION.

DRAWN: M. SIGMON	DATE: 04-15-15
CHECKED:	DATE:

NorComp

SCALE: NTS	SHEET 1	OF 3	REV 2
DWG NO.		CCA-000-MYYR216	

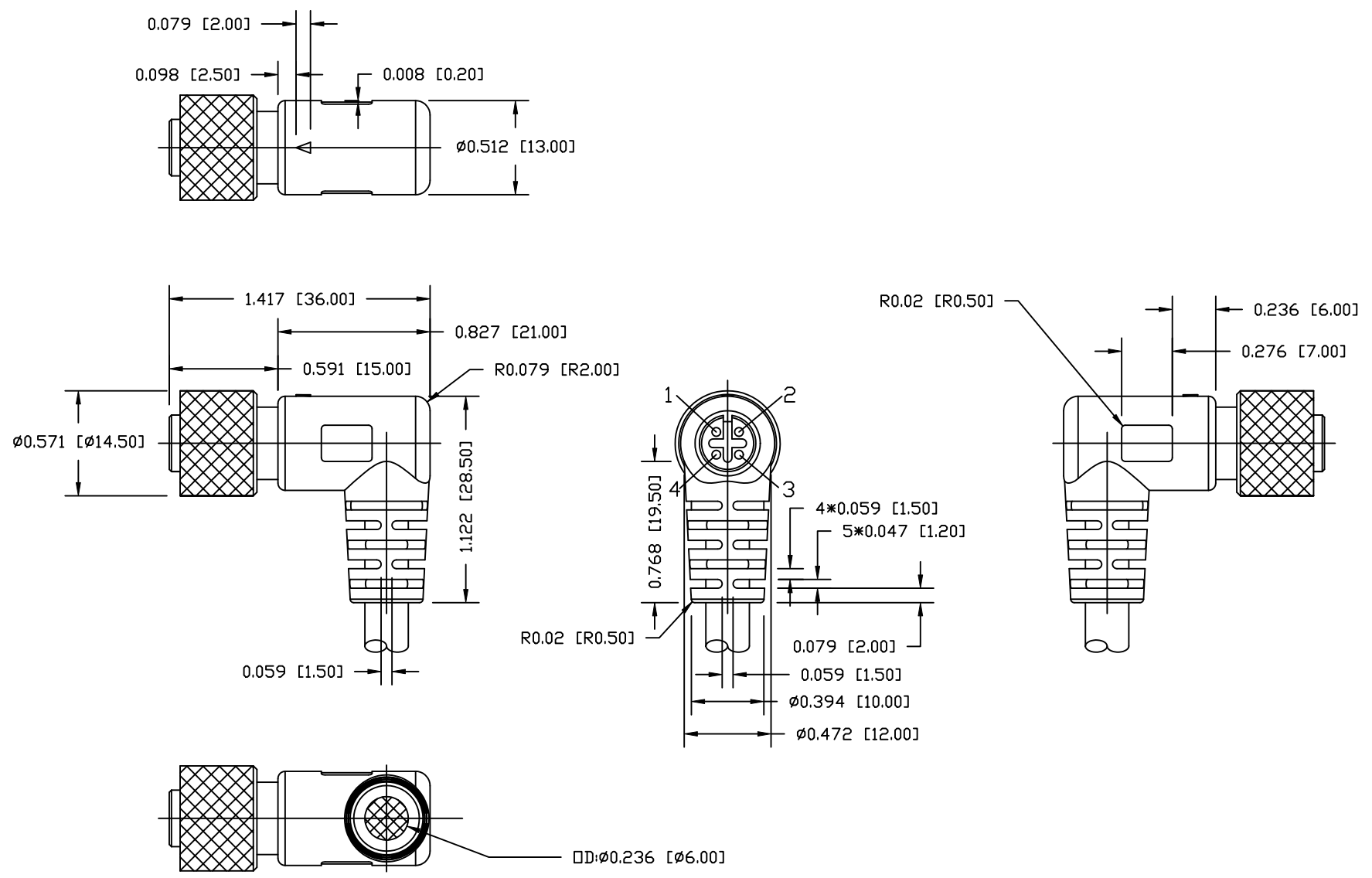

RoHS COMPLIANT

DO NOT SCALE FROM DRAWING



THESE DRAWINGS AND SPECIFICATIONS ARE THE PROPERTY OF NorComp AND SHALL NOT BE REPRODUCED, COPIED OR USED AS THE BASIS FOR THE MANUFACTURE OR SALE OF APPARATUS WITHOUT WRITTEN PERMISSION.

DRAWN: M. SIGMON
 DATE: 04-15-15
 CHECKED:
 DATE:

NorComp

SCALE: NTS
 SHEET 2 OF 3
 REV 2
 DWG NO. CCA-000-MYYR216

ELECTRICAL CHARACTERISTICS

VOLTAGE RATING : 30V
 TEMPERATURE RATING : 60°C
 SPARK TEST : AC-2000V/0.15 sec MIN.
 DIELECTRIC STRENGTH : AC-750V/1 sec MIN.
 INSULATION RESISTANCE : PE: DC-500V 15000 MOHM/100M MIN. AT 20°C
 CONDUCTOR RESISTANCE : 24AWG - 93.2 OHM/KM MAX. AT 20°C

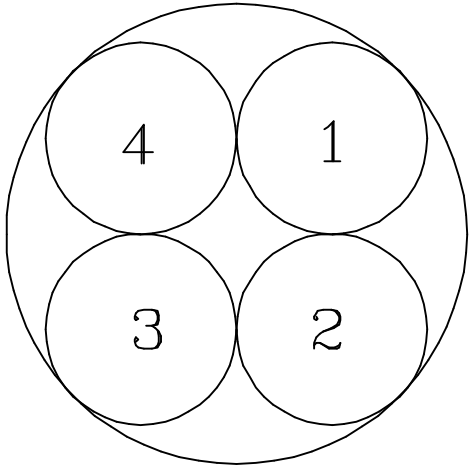
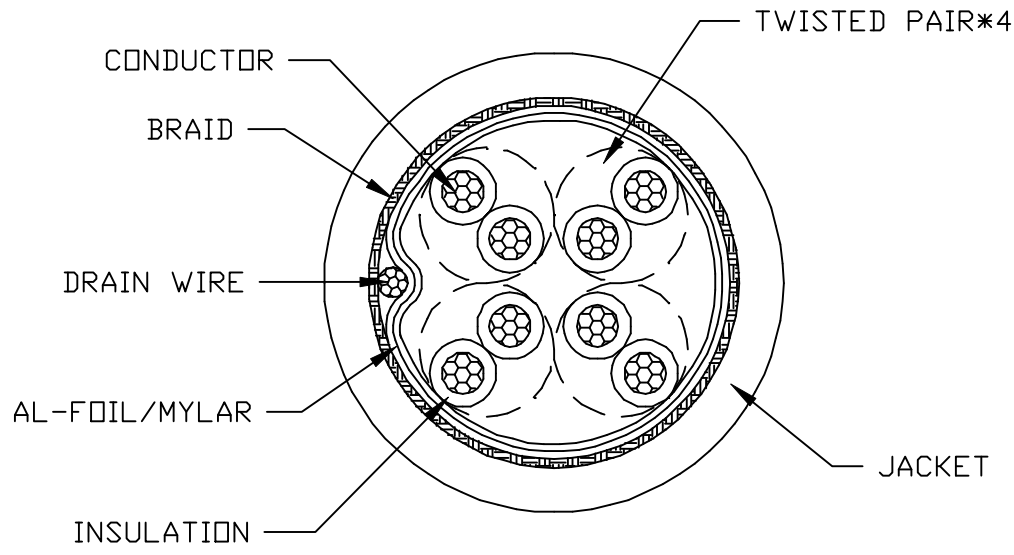

COLOR CODE

- 1. BROWN * BROWN/WHITE
- 2. BLUE * BLUE/WHITE
- 3. ORANGE * ORANGE/WHITE
- 4. GREEN * GREEN/WHITE

RoHS COMPLIANT

DO NOT SCALE FROM DRAWING



THESE DRAWINGS AND SPECIFICATIONS ARE THE PROPERTY OF NorComp AND SHALL NOT BE REPRODUCED, COPIED OR USED AS THE BASIS FOR THE MANUFACTURE OR SALE OF APPARATUS WITHOUT WRITTEN PERMISSION.

DRAWN: M. SIGMON	DATE: 04-15-15
CHECKED:	DATE:

NorComp

SCALE: NTS	SHEET 3	OF 3	REV 2
DWG NO.		CCA-000-MYYR216	