



Chipsmall Limited consists of a professional team with an average of over 10 year of expertise in the distribution of electronic components. Based in Hongkong, we have already established firm and mutual-benefit business relationships with customers from,Europe,America and south Asia,supplying obsolete and hard-to-find components to meet their specific needs.

With the principle of "Quality Parts,Customers Priority,Honest Operation,and Considerate Service",our business mainly focus on the distribution of electronic components. Line cards we deal with include Microchip,ALPS,ROHM,Xilinx,Pulse,ON,Everlight and Freescale. Main products comprise IC,Modules,Potentiometer,IC Socket,Relay,Connector.Our parts cover such applications as commercial,industrial, and automotives areas.

We are looking forward to setting up business relationship with you and hope to provide you with the best service and solution. Let us make a better world for our industry!



Contact us

Tel: +86-755-8981 8866 Fax: +86-755-8427 6832

Email & Skype: info@chipsmall.com Web: www.chipsmall.com

Address: A1208, Overseas Decoration Building, #122 Zhenhua RD., Futian, Shenzhen, China



CD Series 8mm DIP Coded Rotary Switches



Features/Benefits

- **Process sealed – withstands soldering and cleaning**
- **Thru-hole and surface mount models**
- **Compact size saves space – 36% smaller than traditional 10mm DIP**
- **Crisp, positive detent ensures actuation**
- **RoHS compliant**

Typical Applications

- **Address switching applications**
- **Data storage devices**
- **Computer and peripherals**
- **Instrumentation**



Specifications

CONTACT RATING: 0.4 VA max. @ 20 V AC or V DC max.
 MECHANICAL AND ELECTRICAL LIFE:
 CD10 & CD16: 20,000 actuations.
 CD08: 12,000 actuations.
 CONTACT RESISTANCE: 50 milliohms max. initial.
 INSULATION RESISTANCE: 100 megohms min.
 @ 250 V AC min.
 DIELECTRIC STRENGTH: 250 V RMS min. @ sea level.
 OPERATING TEMPERATURE: -25°C to 85°C.
 STORAGE TEMPERATURE: -40°C to 85°C.
 SOLDERABILITY: Per MIL-STD-202F method 208D or EIA RS-186E, method 9 (1 hour steam aging).
 PACKAGING: Switches supplied in rigid tubes in full-tube quantities only: this may affect order quantity. Tube quantity is 60 pieces per tube. Surface mount switches available in tape & reel packaging per EIA 481A, 800 per reel, surface mount with “M0” actuator only.

Materials

COVER: PPS (UL94V-0), Color; Black.
 BASE: PPS (UL94V-0), Color; Black
 ACTUATOR: LCP (UL 94V-0), Color White (CDXXR)
 Color Black (CDXXC)
 Note: internal o-ring seal standard with all actuators.
 MOVABLE CONTACTS: Copper alloy with gold plate over nickel plate.
 STATIONARY CONTACTS: Copper alloy with gold plate over nickel plate.
 TERMINALS: Copper alloy with gold plate over nickel plate.

Note: Specifications and materials listed above are for switches with standard options. For information on specific and custom switches, consult Customer Service Center.

How To Order

The Build-A Switch concept allows you to mix and match options to create the switch you need. Below is a complete listing of options shown in catalog. To order, simply select desired option from each category and place in the appropriate box.

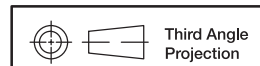
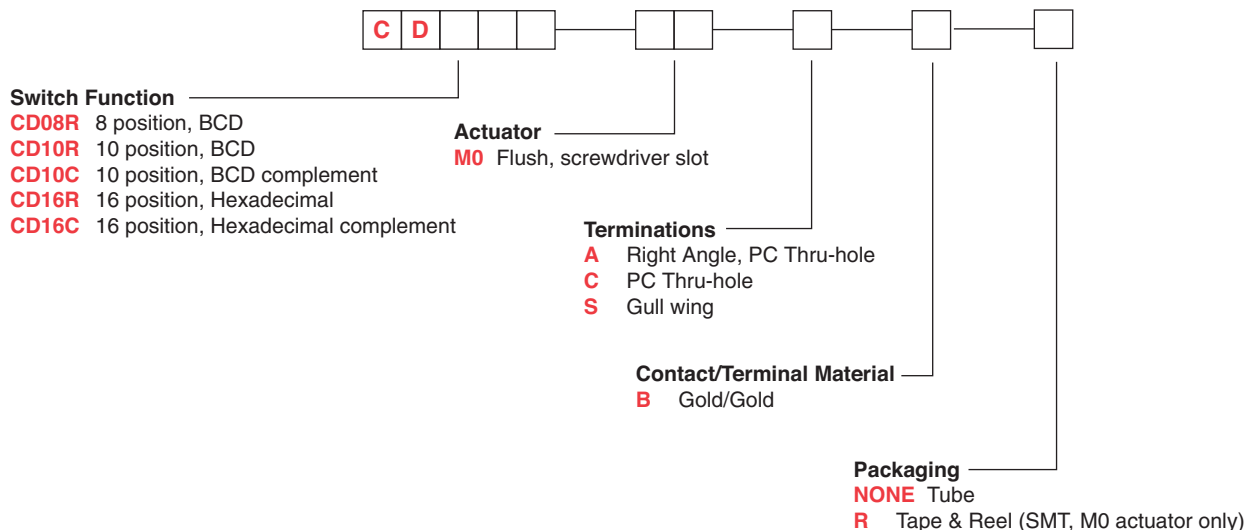

Dimensions are shown: Inch (mm)
 Specifications and dimensions subject to change



CD Series 8mm DIP Coded Rotary Switches

SWITCHES WITH STANDARD OPTIONS

PC Mount



CD16RM0CB

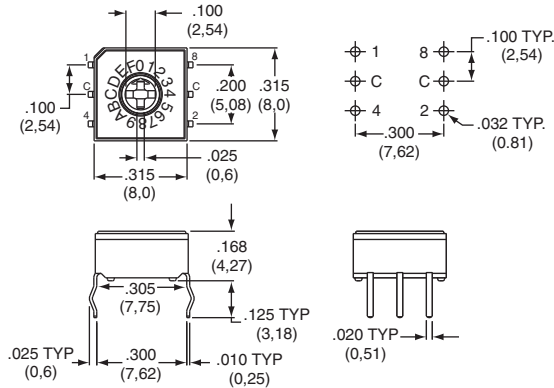

PART NUMBER	NO. POS.	QUANTITY PER TUBE
CD08RM0CB	8	60
CD10RM0CB	10	60
CD10CM0CB	10	60
CD16RM0CB	16	60
CD16CM0CB	16	60

Right Angle Mount



CD10RM0AB

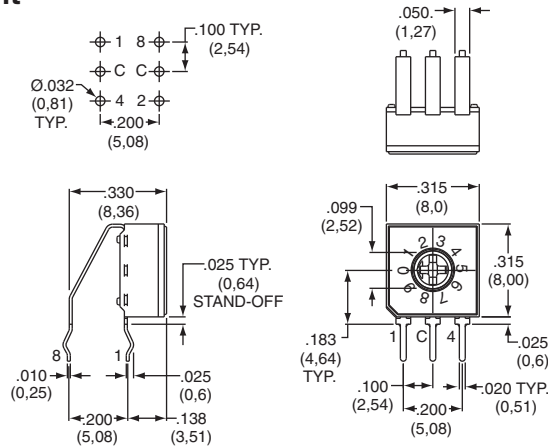

PART NUMBER	NO. POS.	QUANTITY PER TUBE
CD08RM0AB	8	60
CD10RM0AB	10	60
CD10CM0AB	10	60
CD16RM0AB	16	60
CD16CM0AB	16	60

Surface Mount



CD10RM0SB

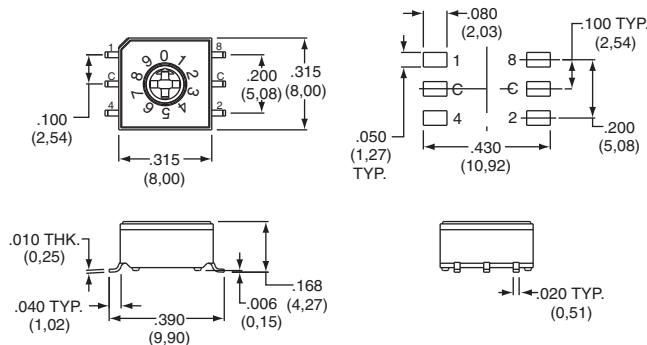

PART NUMBER	NO. POS.	QUANTITY PER TUBE
CD08RM0SB	8	60
CD10RM0SB	10	60
CD10CM0SB	10	60
CD16RM0SB	16	60
CD16CM0SB	16	60

Note: For tape and reel packaging, add 'R' to end of part number.



Third Angle Projection

Dimensions are shown: Inch (mm)
Specifications and dimensions subject to change



CD Series 8mm DIP Coded Rotary Switches



H
DIP

SWITCH FUNCTION

CD08R 8 POSITION, BCD
ACTUATOR COLOR: WHITE

POS.	0	1	2	3	4	5	6	7
C	●	●	●	●	●	●	●	●
1		●		●		●		●
2			●		●		●	
4				●	●	●	●	
8								

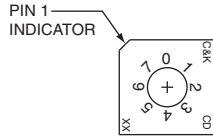

Switches ship and to be solder processed in position "0"

CD10R 10 POSITION, BCD
ACTUATOR COLOR: WHITE

POS.	0	1	2	3	4	5	6	7	8	9
C	●	●	●	●	●	●	●	●	●	●
1		●		●		●		●		●
2			●		●		●		●	
4				●	●	●	●			
8									●	●

Switches ship and to be solder processed in position "0"

CD10C 10 POSITION, BCD COMPLEMENT
ACTUATOR COLOR: BLACK

POS.	0	1	2	3	4	5	6	7	8	9
C	●	●	●	●	●	●	●	●	●	●
1	●		●		●		●		●	
2	●			●		●		●		●
4	●	●	●	●					●	●
8	●	●	●	●	●	●	●	●	●	●

Switches ship and to be solder processed in position "7"

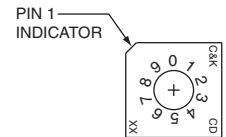

CD16R 16 POSITION, HEXADECIMAL
ACTUATOR COLOR: WHITE

POS.	0	1	2	3	4	5	6	7	8	9	A	B	C	D	E	F
C	●	●	●	●	●	●	●	●	●	●	●	●	●	●	●	●
1		●		●		●		●		●		●		●		●
2			●		●		●		●		●		●		●	
4				●	●	●	●					●	●	●	●	
8																

Switches ship and to be solder processed in position "0"

CD16C 16 POSITION, HEXADECIMAL COMPLEMENT
ACTUATOR COLOR: BLACK

POS.	0	1	2	3	4	5	6	7	8	9	A	B	C	D	E	F
C	●	●	●	●	●	●	●	●	●	●	●	●	●	●	●	●
1	●		●		●		●		●		●		●		●	
2	●			●		●		●		●		●		●		●
4	●	●	●	●								●	●	●	●	
8	●	●	●	●	●	●	●	●	●	●	●	●	●	●	●	●

Switches ship and to be solder processed in position "F"

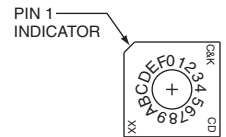

ACTUATOR

M0 (STD.) FLUSH WITH SCREWDRIVER SLOT

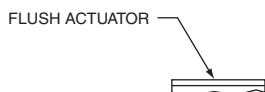
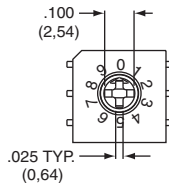

NOTE: Designed for #0 Phillips screwdriver.



Dimensions are shown: Inch (mm)
Specifications and dimensions subject to change



CD Series 8mm DIP Coded Rotary Switches

TERMINATIONS

DIP

H

C PC, THRU-HOLE

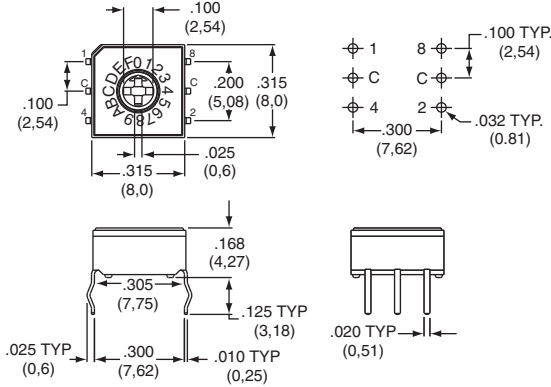

A RIGHT ANGLE, PC THRU-HOLE

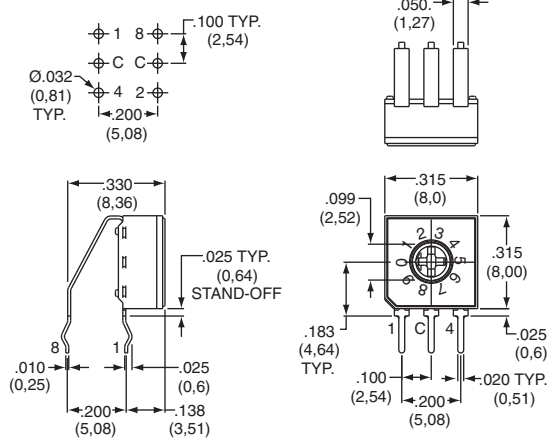

S SURFACE MOUNT

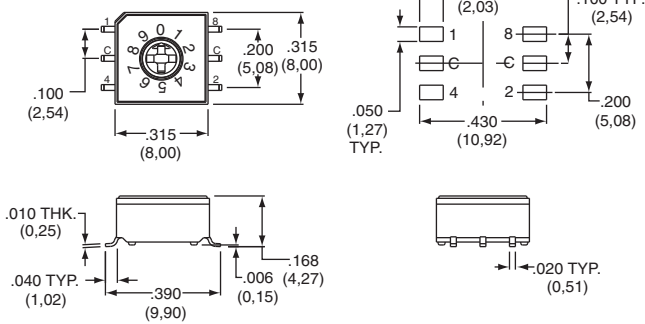

CONTACT MATERIAL

OPTION CODE	RoHS COMPLIANT*	RoHS COMPATIBLE*	CONTACT MATERIAL	TERMINAL PLATING	RATING	
B	YES	YES	GOLD	GOLD	LOW LEVEL/DRY CIRCUIT	0.4 VC MAX. @ 20 V AC or DC MAX.

* Note: See Technical Data section of this catalog for RoHS compliant and compatible definitions and specifications.

TAPE & REEL

For part number CDxxM0SB

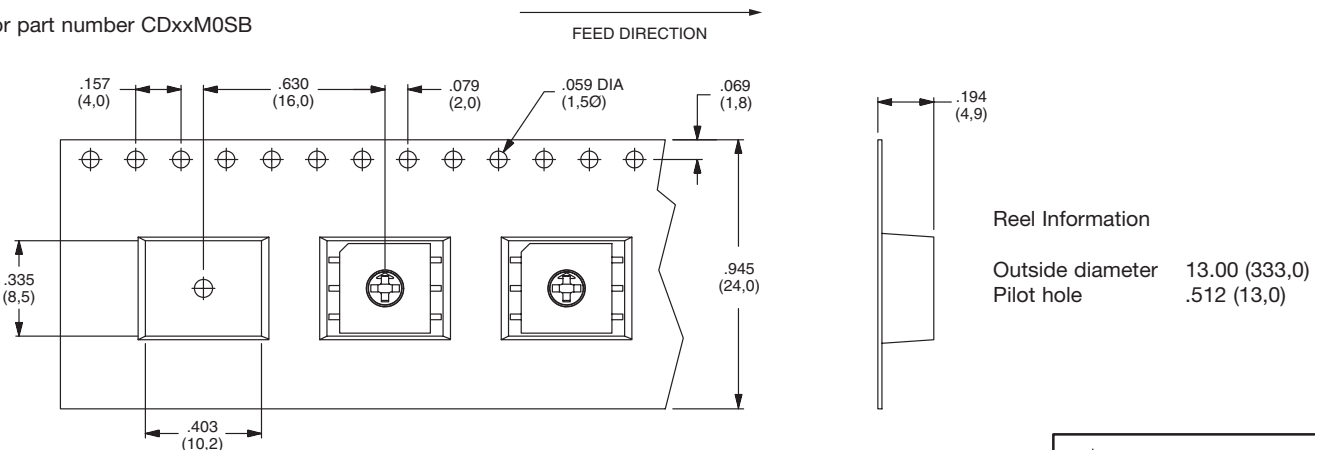

Reel Information

Outside diameter 13.00 (333,0)
Pilot hole .512 (13,0)



Third Angle
Projection

Dimensions are shown: Inch (mm)
Specifications and dimensions subject to change

