



Chipsmall Limited consists of a professional team with an average of over 10 year of expertise in the distribution of electronic components. Based in Hongkong, we have already established firm and mutual-benefit business relationships with customers from,Europe,America and south Asia,supplying obsolete and hard-to-find components to meet their specific needs.

With the principle of “Quality Parts,Customers Priority,Honest Operation,and Considerate Service”,our business mainly focus on the distribution of electronic components. Line cards we deal with include Microchip,ALPS,ROHM,Xilinx,Pulse,ON,Everlight and Freescale. Main products comprise IC,Modules,Potentiometer,IC Socket,Relay,Connector.Our parts cover such applications as commercial,industrial, and automotives areas.

We are looking forward to setting up business relationship with you and hope to provide you with the best service and solution. Let us make a better world for our industry!



## Contact us

Tel: +86-755-8981 8866 Fax: +86-755-8427 6832

Email & Skype: info@chipsmall.com Web: www.chipsmall.com

Address: A1208, Overseas Decoration Building, #122 Zhenhua RD., Futian, Shenzhen, China



## CDBA220-G Thru. CDBA2100-G

Reverse Voltage: 20 to 100 Volts

Forward Current: 2.0 Amp

RoHS Device

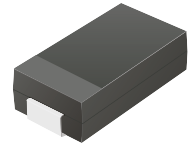

### Features

- Ideal for surface mount applications.
- Easy pick and place.
- Plastic package has Underwriters Lab. flammability classification 94V-0.
- Built-in strain relief.
- Low forward voltage drop.

### Mechanical data

- Case: JEDEC DO-214AC, molded plastic.
- Terminals: solderable per MIL-STD-750, method 2026.
- Polarity: Color band denotes cathode end.
- Approx. weight: 0.064 grams

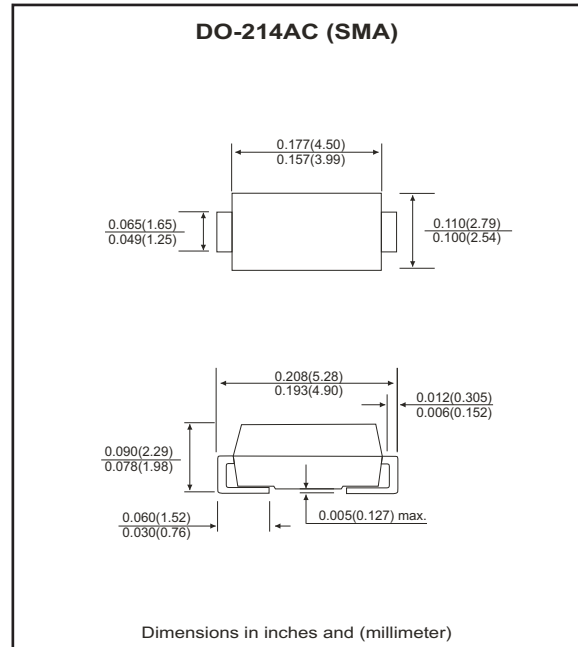

### Maximum Ratings and Electrical Characteristics

Parameter	Symbol	CDBA 220-G	CDBA 240-G	CDBA 260-G	CDBA 280-G	CDBA 2100-G	Units	
Max. repetitive peak reverse voltage	$V_{RRM}$	20	40	60	80	100	V	
Max. DC blocking voltage	$V_{DC}$	20	40	60	80	100	V	
Max. RMS voltage	$V_{RMS}$	14	28	42	56	70	V	
Peak surge forward current, 8.3ms single half sine-wave superimposed on rate load (JEDEC method)	$I_{FSM}$	50						A
Max. average forward current	$I_o$	2.0						A
Max. instantaneous forward voltage at 2.0A	$V_F$	0.50		0.70	0.85		V	
Max. DC reverse current at $T_A=25\text{ }^{\circ}\text{C}$ rated DC blocking voltage $T_A=100\text{ }^{\circ}\text{C}$	$I_R$	0.5			10		mA	
Max. thermal resistance (Note 1)	$R_{\theta JA}$ $R_{\theta JL}$	75			17		$^{\circ}\text{C/W}$	
Max. operating junction temperature	$T_J$	125					$^{\circ}\text{C}$	
Storage temperature	$T_{STG}$	-65 to +150					$^{\circ}\text{C}$	

Notes: 1. Thermal resistance from junction to ambient and junction to lead mounted on P.C.B. with 5.0x5.0 mm copper pad area.

## RATING AND CHARACTERISTIC CURVES (CDBA220-G thru CDBA2100-G)

Fig.1 Reverse Characteristics

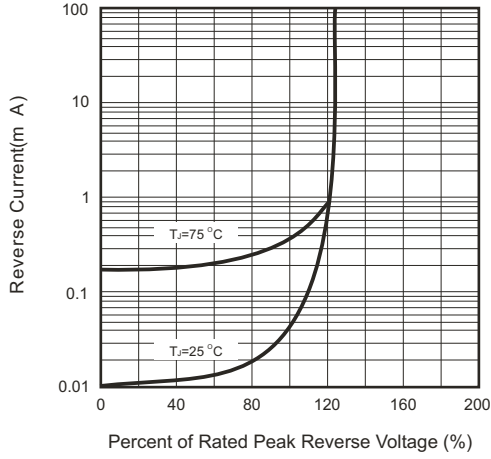

Fig.2 Forward Characteristics

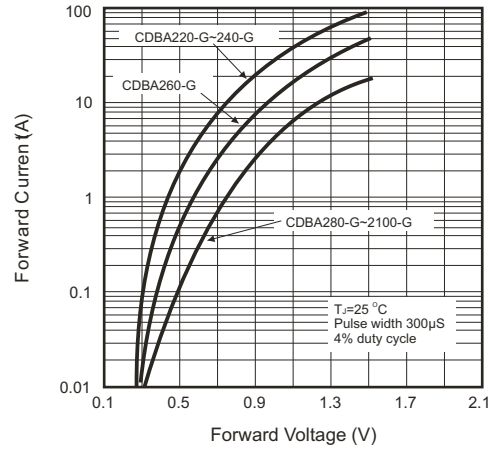

Fig.3 Junction Capacitance

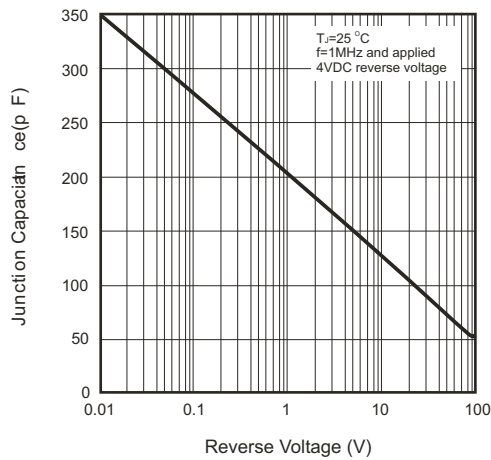

Fig.4 Current Derating Curve

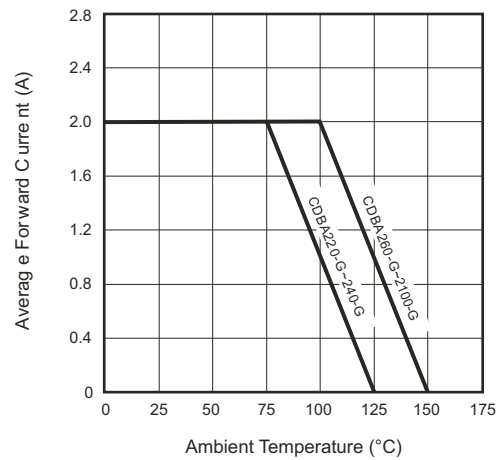
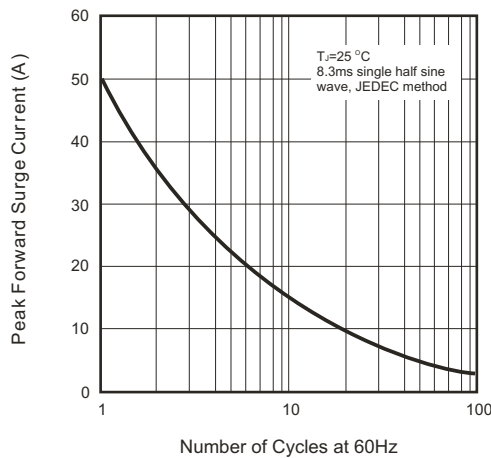
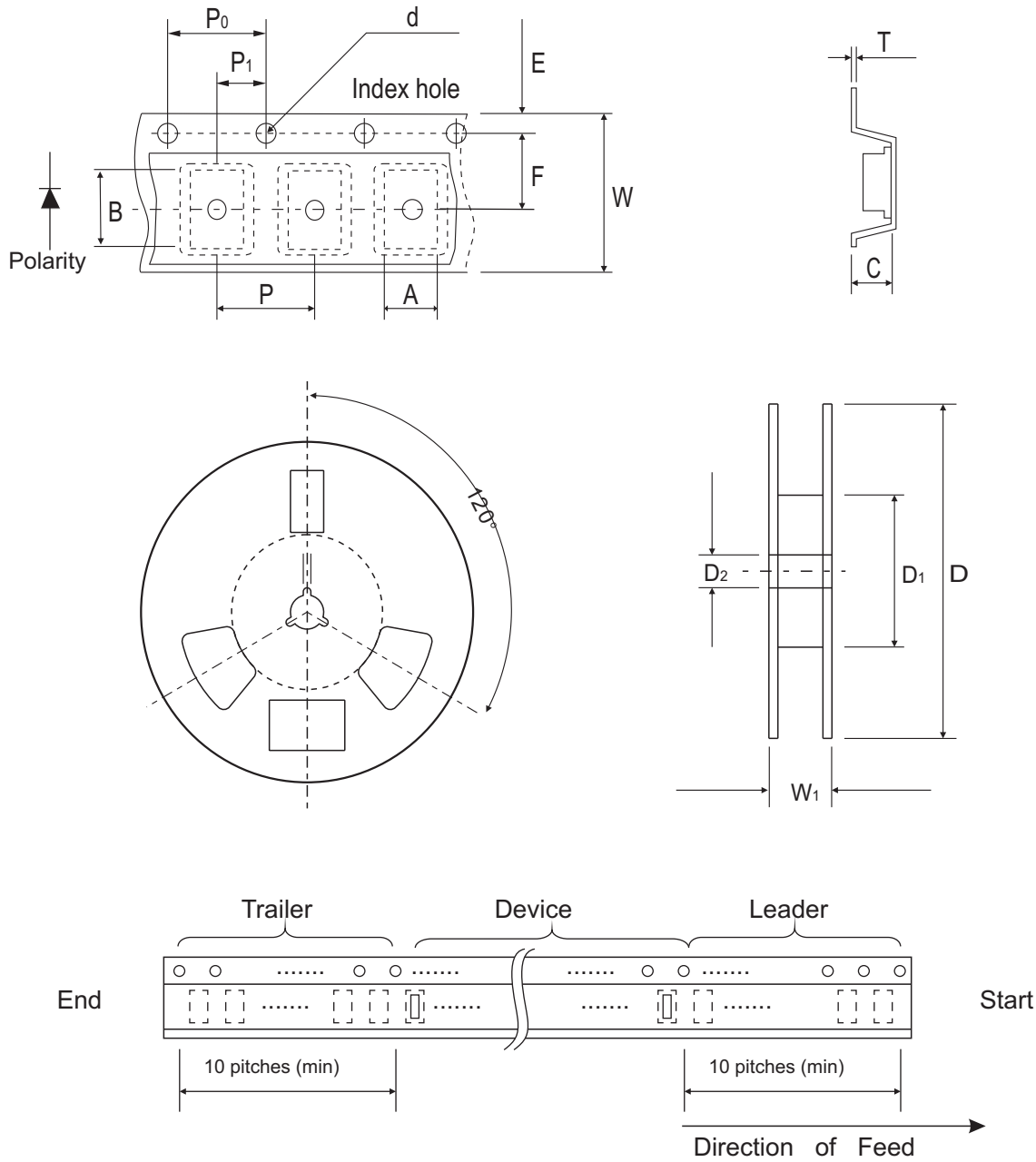

Fig.5 Non-repetitive Forward Surge Current



## Reel Taping Specification



DO-214AC (SMA)	SYMBOL	<b>A</b>	<b>B</b>	<b>C</b>	<b>d</b>	<b>D</b>	<b>D1</b>	<b>D2</b>
	(mm)	2.7 Max	5.3 Max	2.66 Max	1.50 ± 0.10 DIA	330 ± 2.00	50.0 Min.	13.5 ± 1.00
	(inch)	0.106 Max	0.209 Max	0.105 Max	0.059 ± 0.004 DIA	13.00 ± 0.079	1.969 Min.	0.531 ± 0.039

DO-214AC (SMA)	SYMBOL	<b>E</b>	<b>F</b>	<b>P</b>	<b>P0</b>	<b>P1</b>	<b>W</b>	<b>W1</b>
	(mm)	1.75 ± 0.10	5.50 ± 0.05	4.00 ± 0.10	4.00 ± 0.10	2.00 ± 0.05	12.0 ± 0.30	18.4 Max.
	(inch)	0.689 ± 0.004	0.216 ± 0.002	0.157 ± 0.004	0.157 ± 0.004	0.079 ± 0.002	0.472 ± 0.012	0.724 Max

## Marking Code

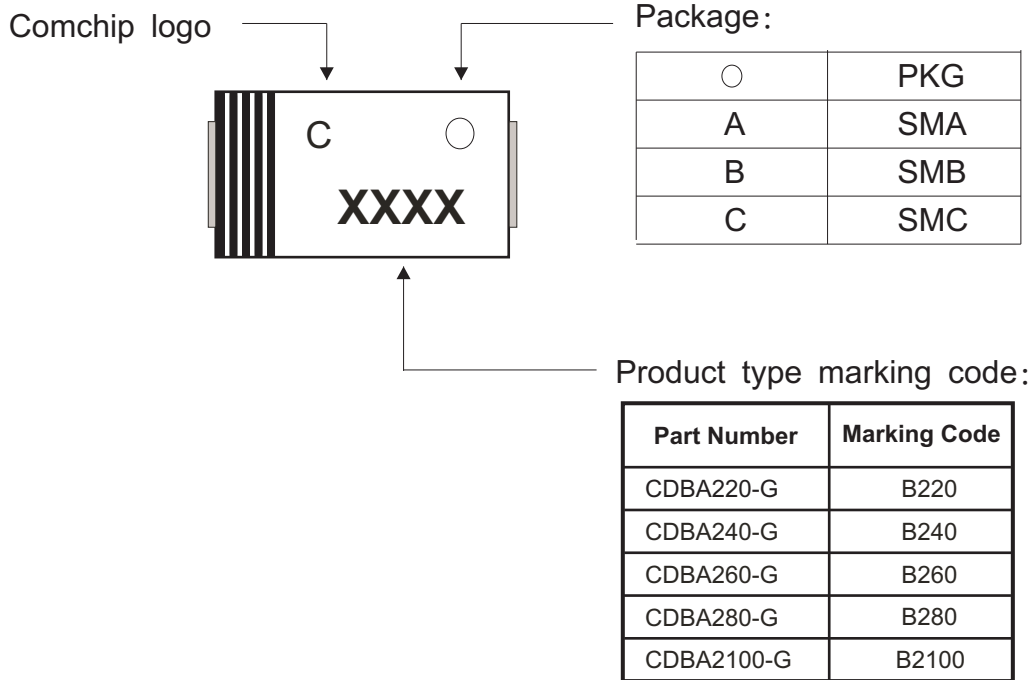

## Suggested PAD Layout

SIZE	DO-214AC(SMA)	
	(mm)	(inch)
A	3.80	0.150
B	1.60	0.063
C	2.80	0.110
D	5.40	0.213
E	2.20	0.087

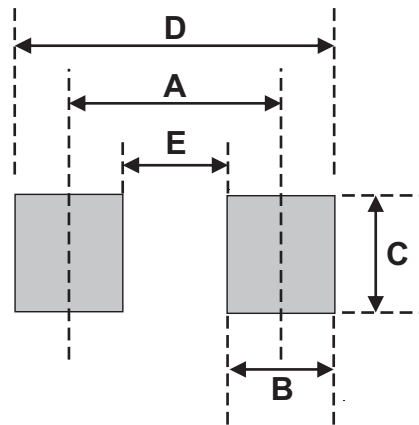

## Standard Packaging

Case Type	REEL PACK	
	REEL ( pcs )	Reel Size (inch)
DO-214AC (SMA)	5,000	13