



Chipsmall Limited consists of a professional team with an average of over 10 year of expertise in the distribution of electronic components. Based in Hongkong, we have already established firm and mutual-benefit business relationships with customers from,Europe,America and south Asia,supplying obsolete and hard-to-find components to meet their specific needs.

With the principle of “Quality Parts,Customers Priority,Honest Operation,and Considerate Service”,our business mainly focus on the distribution of electronic components. Line cards we deal with include Microchip,ALPS,ROHM,Xilinx,Pulse,ON,Everlight and Freescale. Main products comprise IC,Modules,Potentiometer,IC Socket,Relay,Connector.Our parts cover such applications as commercial,industrial, and automotives areas.

We are looking forward to setting up business relationship with you and hope to provide you with the best service and solution. Let us make a better world for our industry!



## Contact us

Tel: +86-755-8981 8866 Fax: +86-755-8427 6832

Email & Skype: info@chipsmall.com Web: www.chipsmall.com

Address: A1208, Overseas Decoration Building, #122 Zhenhua RD., Futian, Shenzhen, China



## Warm Dimming LED Spot Modules

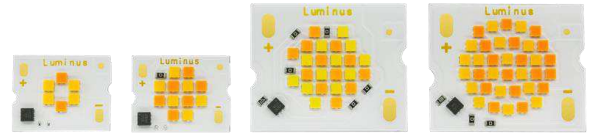

### Features:

- High lumen density for directional lighting
- Dim-to-warm with IC chip and LM-80 tested MP-1616 XNOVA Cube™ LEDs on metal PC board
- Enables system beam angles from 10 to 40 degrees
- Simplifies lamp and luminaire design
- Compatible with most single channel drivers and dimmer switches
- 90 & 97CRI at 3000K warm dimming down to 1800K for residential and hospitality lighting
- 92CRI 4000K to 2700K warm dimming for commercial lighting
- Two dimming curve options: “halogen-like” -DW01 and “linear-style” -DW02
- Consistent white light <3 SDCM
- Specified “hot” performance and 100% factory tested at Tj=85°C

### Applications:

- Hospitality / hotel / restaurant lighting
- Residential lighting
- Retail shop lighting
- Public, commercial buildings
- Ceiling and wall mount lights

### Products Families:

- CDM-6-XXXX-YY-18-DW0x: Typical 5.5W
- CDM-9-XXXX-YY-36-DW0x: Typical 11W
- CDM-14-XXXX-YY-36-DW0x: Typical 21.5W
- CDM-18-XXXX-YY-36-DW0x: Typical 32.5W
  - XXXX: CCT range (“3018” = 3000K to 1800K)
  - YY: CRI (“90” = either 92 or 97 min, refer to page 3)
  - “18” or “36” = nominal voltage
  - DW01 = standard configuration with “halogen-like” dimming curve
  - DW02= standard configuration with “linear-style” dimming curve

## Technical Data

### Electrical data and maximum ratings (@T<sub>j</sub> =85°C):

Part Number	Nominal Input Power	Maximum Input Power	Nominal Current	Absolute Maximum Current	Typical Voltage@ Nominal Current	Maximum Voltage @ Nominal Current
CDM-6-3018-90-18-DW0x	5.5W	8.5W	300mA	440mA	17.8V	19V
CDM-6-4027-90-18-DW0x	5.5W	8.5W	300mA	440mA	17.8V	19V
CDM-9-3018-90-36-DW0x	11W	14.5W	300mA	440mA	35.5V	38V
CDM-9-4027-90-36-DW0x	11W	14.5W	300mA	440mA	35.5V	38V
CDM-14-3018-90-36-DW0x	21.5W	32.5W	600mA	800mA	35.5V	38V
CDM-14-4027-90-36-DW0x	21.5W	32.5W	600mA	800mA	35.5V	38V
CDM-18-3018-90-36-DW0x	32.5W	40W	900mA	1080mA	35.5V	38V
CDM-18-4027-90-36-DW0x	32.5W	40W	900mA	1080mA	35.5V	38V

### Absolute maximum ratings & optical/electrical characteristics:

Parameter	Symbol	Minimum	Typical	Maximum	Unit
Operating case temperature	T <sub>c</sub>			105	°C
Junction temperature	T <sub>j</sub>			125	°C
Viewing angle	2(Θ1/2)		130		degrees
Reverse voltage	V <sub>r</sub>			5	volts
Ambient operating temperature	T <sub>opr</sub>	-40		+85	°C
Storage temperature	T <sub>sto</sub>	-40		+85	°C
Electrostatic Discharge	ESD			4000V	HBM



**Photometric data (@nominal forward current & T<sub>j</sub> =85°C):**

**Halogen-like (-DW01) Series**

Part number	Nominal Current	Minimum Flux (lumens)	Typical Luminous Efficacy	Typical Flux (lumens)	Minimum CRI (Ra)
CDM-6-3018-90-18-DW01	300mA	465	92lm/W	490	90
CDM-6-4027-90-18-DW01	300mA	500	98lm/W	525	92
CDM-9-3018-90-36-DW01	300mA	880	87lm/W	925	97
CDM-9-4027-90-36-DW01	300mA	990	98lm/W	1040	92
CDM-14-3018-90-36-DW01	600mA	1760	87lm/W	1850	97
CDM-14-4027-90-36-DW01	600mA	1980	98lm/W	2085	92
CDM-18-3018-90-36-DW01	900mA	2730	90lm/W	2875	97
CDM-18-4027-90-36-DW01	900mA	3030	100lm/W	3190	92

**Linear-style (-DW02) Series**

Part number	Nominal Current	Minimum Flux	Typical Luminous Efficacy	Typical Flux	Minimum CRI (Ra)
CDM-6-3018-90-18-DW02	300mA	416	82lm/W	438	90
CDM-6-4027-90-18-DW02	300mA	470	93lm/W	495	92
CDM-9-3018-90-36-DW02	300mA	827	82lm/W	870	97
CDM-9-4027-90-36-DW02	300mA	941	93lm/W	990	92
CDM-14-3018-90-36-DW02	600mA	1658	82lm/W	1745	97
CDM-14-4027-90-36-DW02	600mA	1881	93lm/W	1980	92
CDM-18-3018-90-36-DW02	900mA	2565	85lm/W	2700	97
CDM-18-4027-90-36-DW02	900mA	2874	95lm/W	3025	92

**Mechanical, Thermal, Optical and Electrical Characteristics:**

Product Description	Min. CRI (Ra)	CCT at over 90% nominal current	CCT at below 10% nominal current	Light Emitting Surface Diameter	Board Size	Typical Thermal Resistance (Rth <sub>j-c</sub> )
CDM-6-3018-90-18-DW0x	90	3000K	1800K	6.8mm	12x15mm	2.65 K/W
CDM-6-4027-90-18-DW0x	92	4000K	2700K	6.8mm	12X15mm	2.65 K/W
CDM-9-3018-90-36-DW0x	97	3000K	1800K	9.5mm	12x15mm	1.8 K/W
CDM-9-4027-90-36-DW0x	92	4000K	2700K	9.5mm	12x15mm	1.8 K/W
CDM-14-3018-90-36-DW0x	97	3000K	1800K	15.5mm	20x24mm	0.67 K/W
CDM-14-4027-90-36-DW0x	92	4000K	2700K	15.5mm	20x24mm	0.67 K/W
CDM-18-3018-90-36-DW0x	97	3000K	1800K	16.8mm	20x24mm	0.52 K/W
CDM-18-4027-90-36-DW0x	92	4000K	2700K	16.8mm	20x24mm	0.52 K/W

**CCT Change Dimming Curves:**

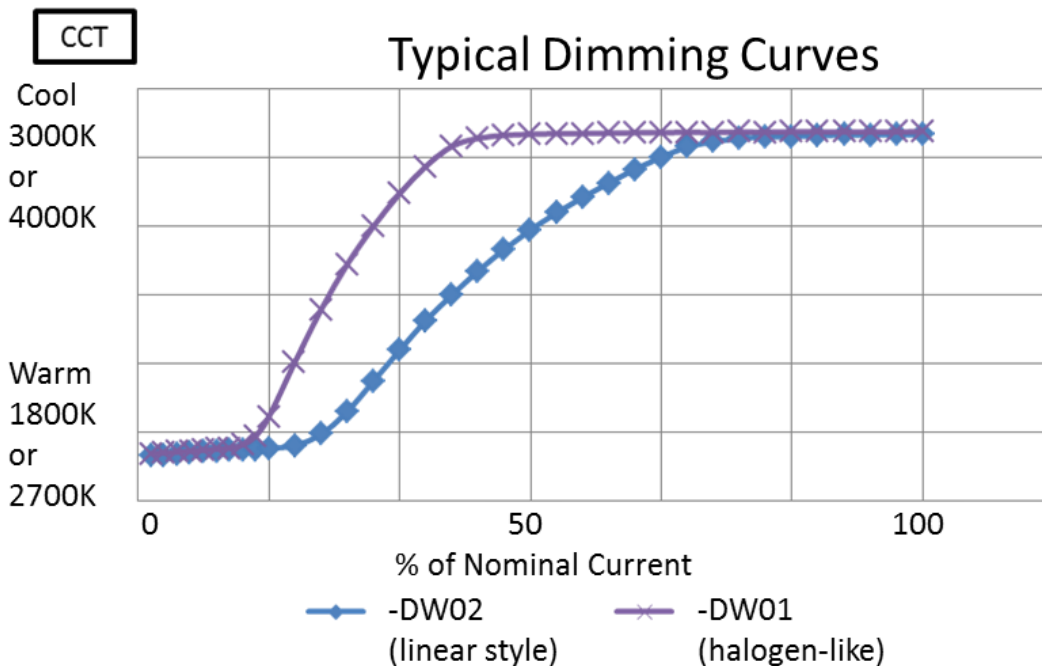

“-DW01” Product Family & Nominal CCTs	Center Point		3-Step		
	CIE <sub>x</sub>	CIE <sub>y</sub>	$\theta$ (°)	a	b
CDM-3018 @ 1800K	0.5656	0.4136	46.510	0.00989	0.00476
CDM-4027 @ 2700K	0.4700	0.4120	54.394	0.00964	0.00421
CDM-3018 @ 3000K	0.4306	0.3998	57.059	0.00961	0.00400
CDM-4027 @ 4000K	0.3799	0.3781	60.532	0.00974	0.00376

“-DW02” Product Family & Nominal CCTs	Center Point		3-Step		
	CIE <sub>x</sub>	CIE <sub>y</sub>	$\theta$ (°)	a	b
CDM-3018 @ 1800K	0.5656	0.4136	46.510	0.00989	0.00476
CDM-4027 @ 2700K	0.4700	0.4120	54.394	0.00964	0.00421
CDM-3018 @ 3000K	0.4376	0.4015	56.525	0.00959	0.00403
CDM-4027 @ 4000K	0.3853	0.3808	60.158	0.00972	0.00379

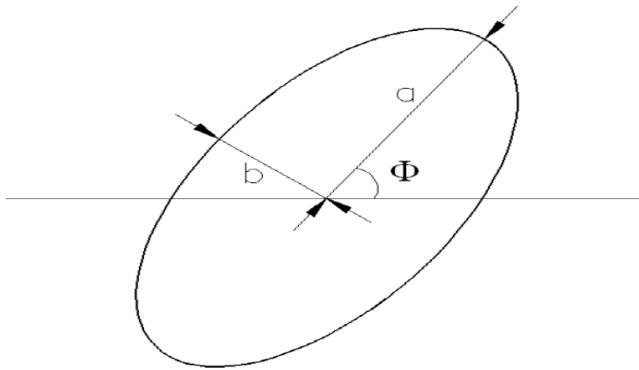

Note: tolerance of chromaticity measurements (x, y) is +/- .005

**CDM-4027 and 3018 "-DW01" Chromaticity Bin Structures**

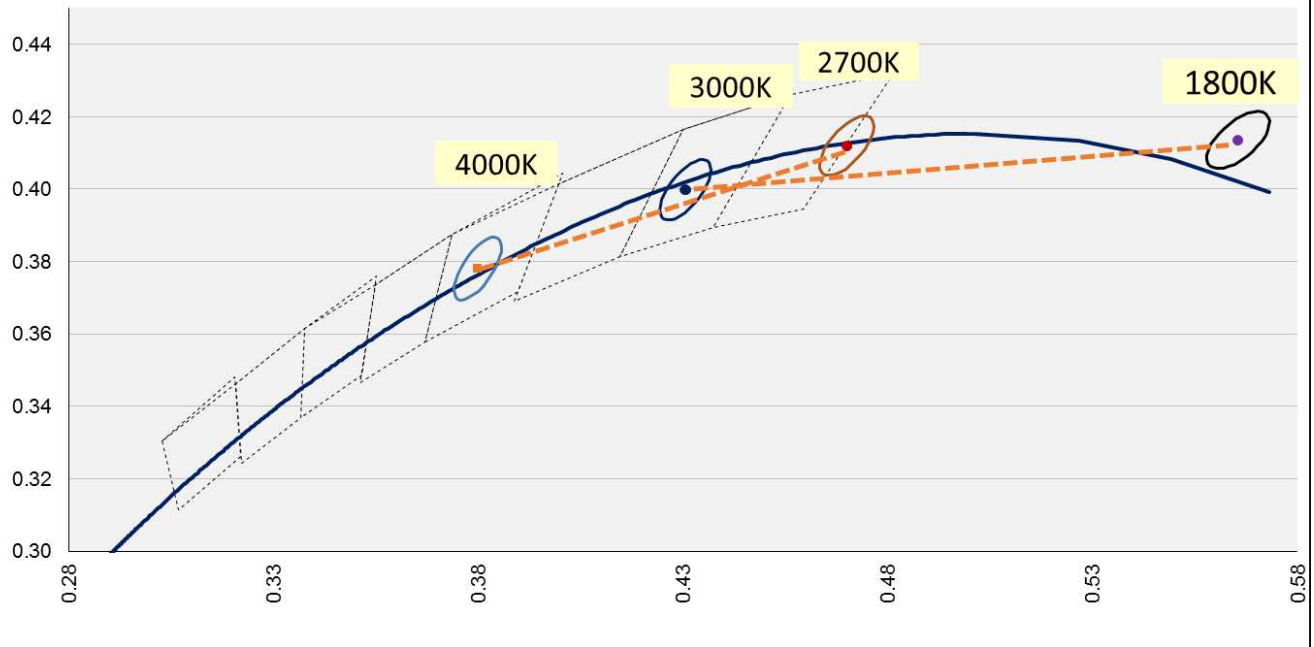

**CDM-4027 and 3018 "-DW02" Chromaticity Bin Structures**

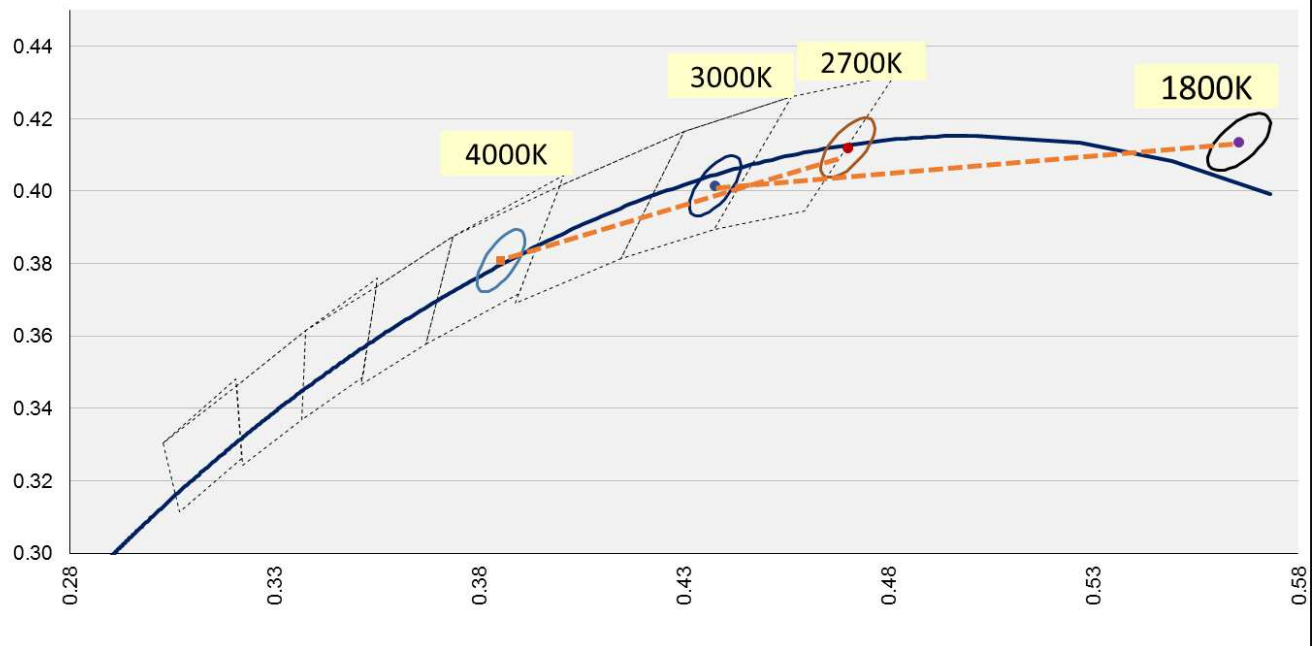

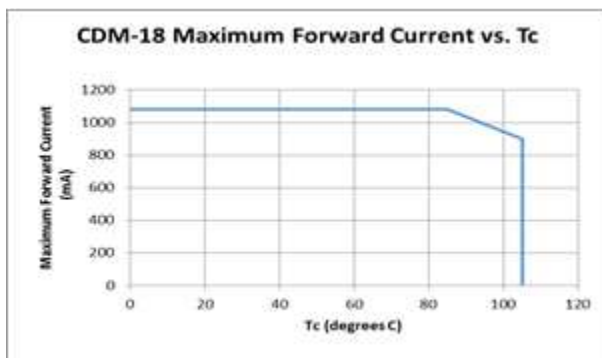
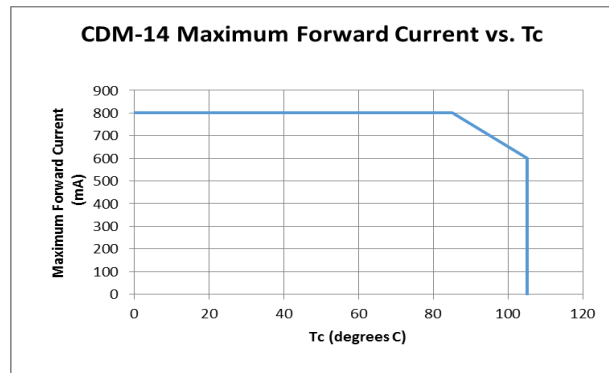
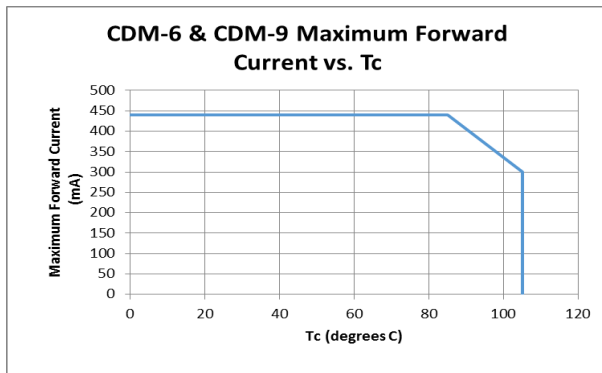
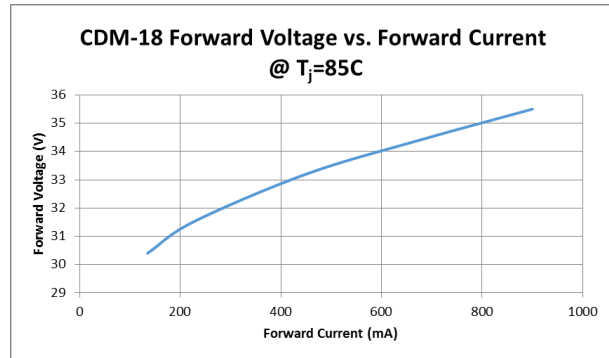
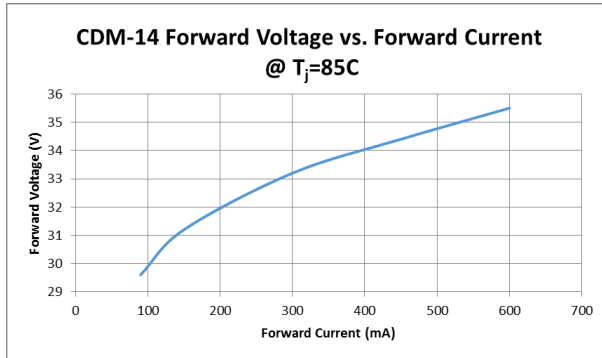
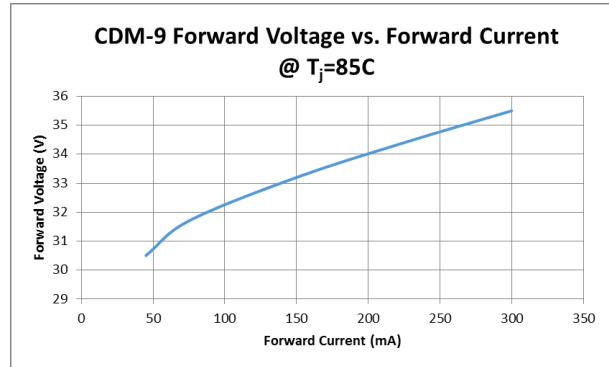
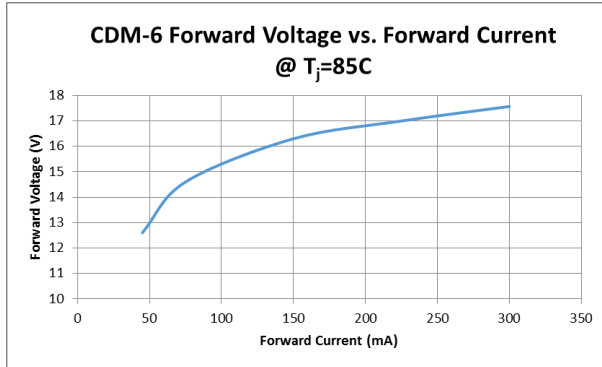



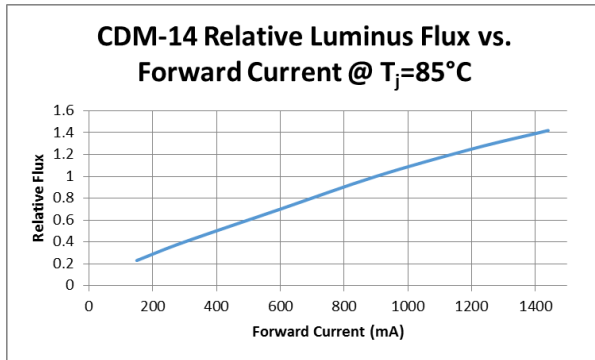
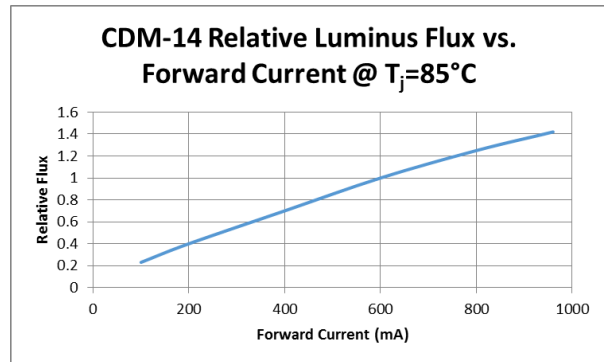
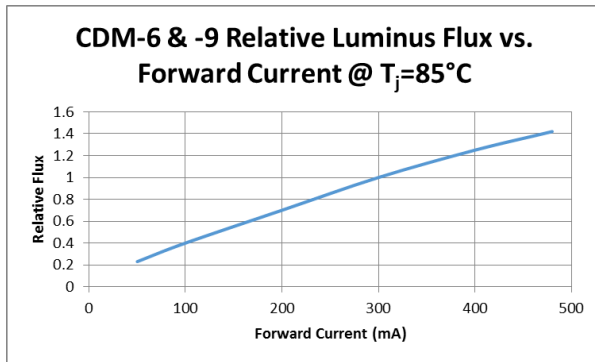
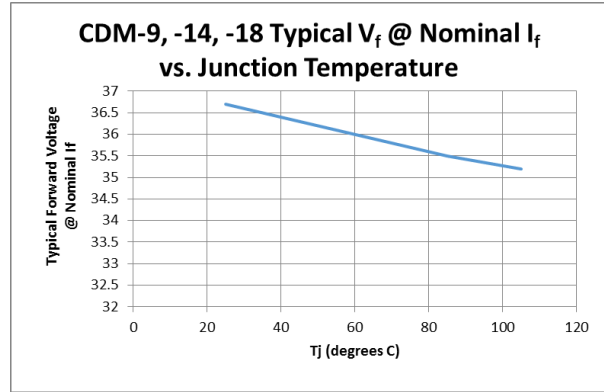
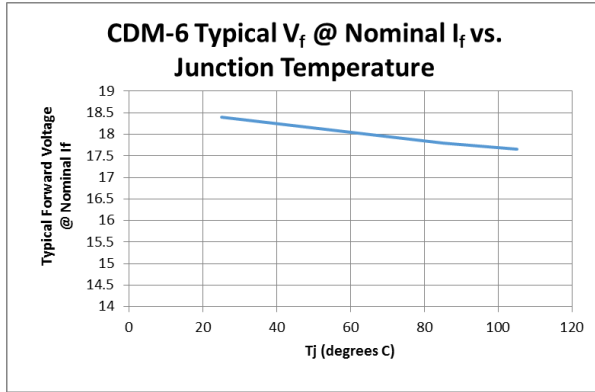

## CDM-6 Series Package Dimensions:

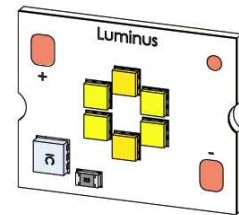
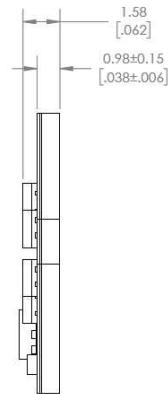
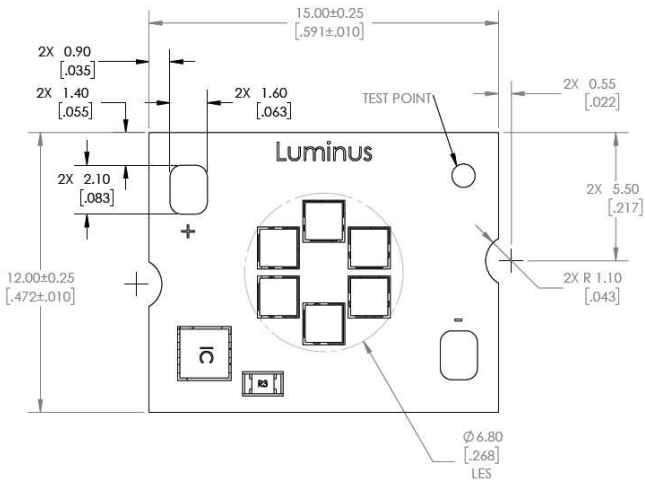

## CDM-9 Series Package Dimensions:

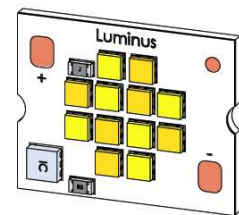
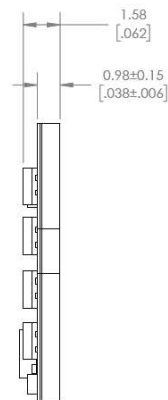
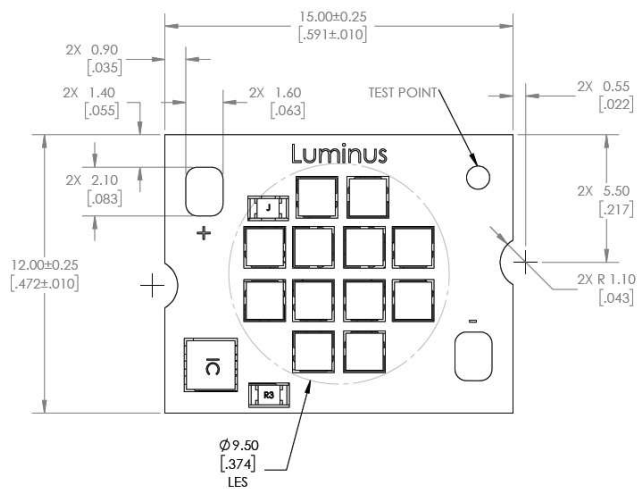

## CDM-14 Series Package Dimensions:

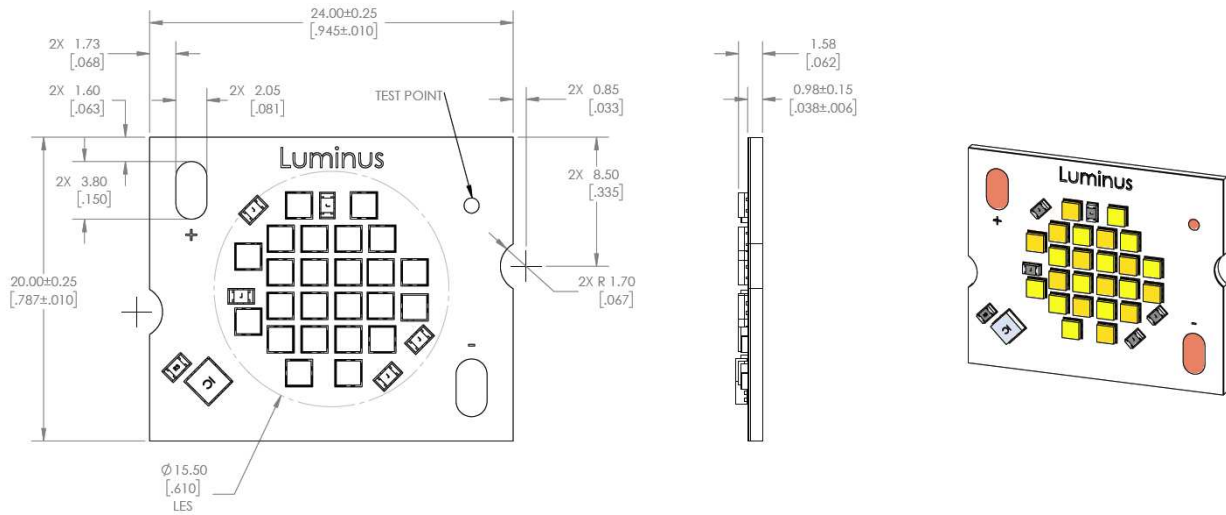

## CDM-18 Series Package Dimensions:

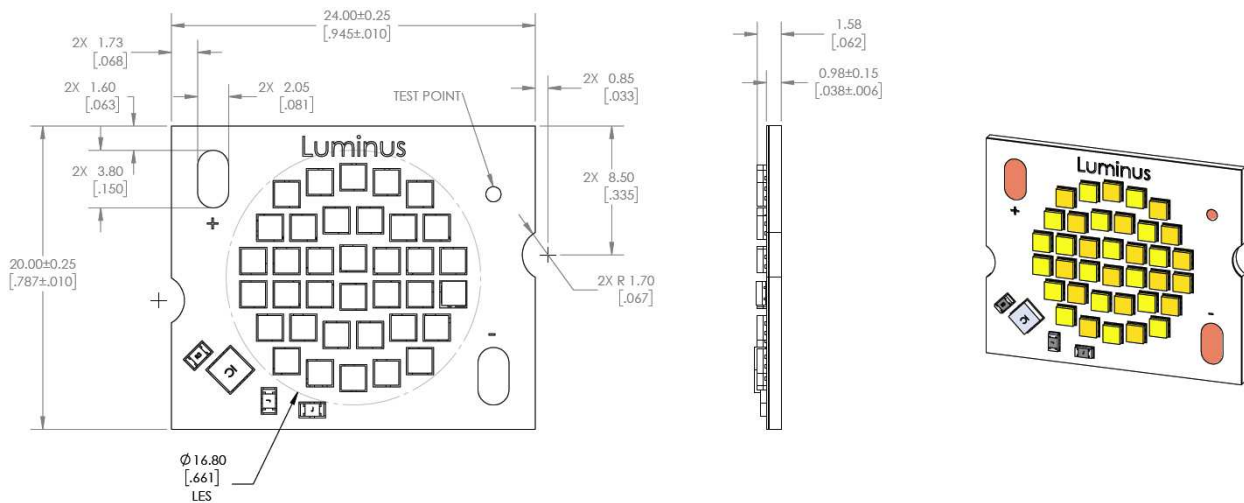

## Shipping Container (CDM-6 and CDM-9)

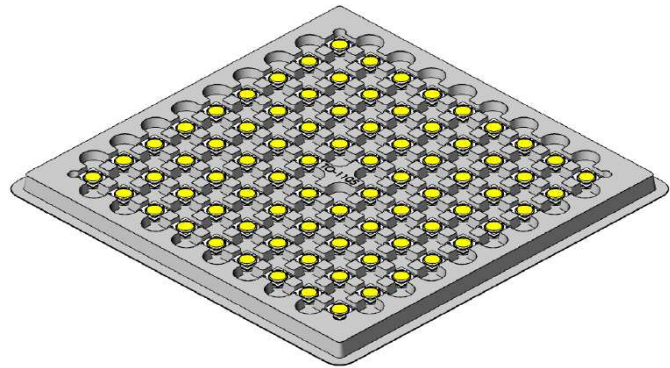
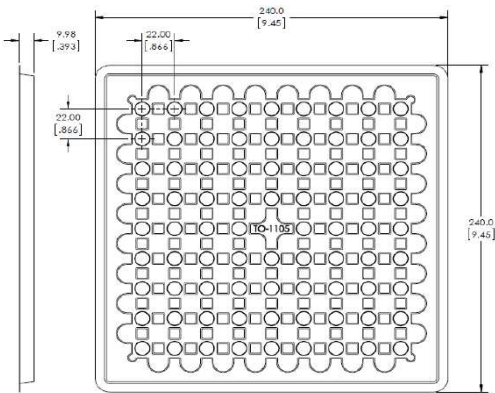

## Shipping Container (CDM-14 and CDM-18):

Similar to above but 30 pcs per tray and 150 pcs per box

### Luminus Label Model:

		<b>Luminus Devices Inc</b>		<b>RoHS Compliant</b>
XXXXXX-XX-XX (Manufacturer Part Number & Bin Kits)		Rev XX		
[Bar code]		[Bar code]		
XXX-XX-XX-XX-XX-XXXX-XX-X (Customer Part Number)				
XXXXXXXXXXXXXXXX (Box ID)		Qty: XX		
[Bar code]		[Bar code]		

### Handling Notes for Luminus COBs

Luminus products are designed for robust performance in general lighting applications; however, care must be taken when handling and assembling the LEDs into their fixtures. To avoid damaging Luminus COBs, please follow these guidelines. The following is an overview of the application notes detailing some of the practices to follow when working with these devices. More detailed information is available on the Luminus website at [www.luminus.com](http://www.luminus.com)

### General Handling

Devices are made to be lifted or carried with tweezers on two “mouse bite” locations. At no time should the devices be handled by or should anything come in contact with the light emitting surface (LES) area. There are electrical connections under the LES which, if damaged, will cause the device to fail.

### Static Electricity

LEDs are electronic devices which can be damaged by electrostatic discharge (ESD). Please use appropriate measures to assure the devices do not experience ESD during their handling and/or storage. ESD protection guidelines should be used at all times when working with LEDs.

**Storage:** Luminus products are delivered in ESD shielded bags and should be stored in these bags until used.

**Assembly:** Individuals handling LEDs during assembly should be trained in ESD protection practices. Assemblers should maintain constant conductive contact with a path to ground by means of a wrist strap, ankle straps, mat, or other ESD protection system.

**Transporting:** When transporting the devices from one assembly area to another, ESD shielded cards and carriers should be used.

### Electrical Contact

Luminus COBs are designed with electrical contact pads on their top surface. These pads are clearly marked with “+” and “-” polarity. Wires can be soldered to the contact pads for electrical connections or other solderless connector products are available. If wires are being soldered to the COB product, we recommend attaching these wires prior to mounting the devices to a heat sink. Please contact Luminus for specific recommendations on how to solder wires if not familiar with the standard practice. Luminus can also offer design recommendations for jigs to enable easy soldering of multiple products in rapid succession.

### Chemical Compatibility

The resin material used to form the emitters inside the LES can get hydrocarbons from the surrounding environment. As a result, certain chemical compounds are not recommended for use with Luminus products. Use of these compounds can cause damage to the light output of the device and may permanently damage the device. Please refer to [www.luminus.com](http://www.luminus.com) for a list of the compounds not recommended for use with Luminus COB products.

### Thermal Interface Material (TIM)

Proper thermal management is critical for successful operation of any LED system. Excess operating temperature can reduce the light output of the device, and excessive heating can cause permanent damage to the device. Proper TIM material is a crucial component for effective heat transfer away from the LED during normal operation. Please refer to [www.luminus.com](http://www.luminus.com) for specific recommendations for TIM solutions.

### Human Eye Safety

Caution must be taken not to stare at the light emitted from Luminus LEDs, as severe eye damage may occur.