



Chipsmall Limited consists of a professional team with an average of over 10 year of expertise in the distribution of electronic components. Based in Hongkong, we have already established firm and mutual-benefit business relationships with customers from,Europe,America and south Asia,supplying obsolete and hard-to-find components to meet their specific needs.

With the principle of “Quality Parts,Customers Priority,Honest Operation,and Considerate Service”,our business mainly focus on the distribution of electronic components. Line cards we deal with include Microchip,ALPS,ROHM,Xilinx,Pulse,ON,Everlight and Freescale. Main products comprise IC,Modules,Potentiometer,IC Socket,Relay,Connector.Our parts cover such applications as commercial,industrial, and automotives areas.

We are looking forward to setting up business relationship with you and hope to provide you with the best service and solution. Let us make a better world for our industry!



Contact us

Tel: +86-755-8981 8866 Fax: +86-755-8427 6832

Email & Skype: info@chipsmall.com Web: www.chipsmall.com

Address: A1208, Overseas Decoration Building, #122 Zhenhua RD., Futian, Shenzhen, China



SMD Power Inductor CDRH3D28/LD

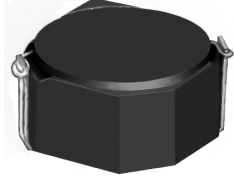
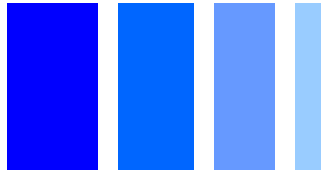

Description

- Ferrite drum core construction.
- Magnetically shielded.
- L × W × H: 4.0 × 4.0 × 3.0 mm Max.
- Product weight: 130mg (Ref.)
- Moisture Sensitivity Level: 1
- RoHS compliance.

Environmental Data

- Operating temperature range: -40°C ~ +105°C (including coil's self temperature rise)
- Storage temperature range: -40°C ~ +105°C
- Solder reflow temperature: 260 °C peak.

Packaging

- Carrier tape and reel packaging
- 7.0" diameter reel
- 500pcs per reel

Applications

- Ideally used in Mobilephone, PDA, MP3, DSC/DVC, Portable DVD, etc. as DC-DC converter inductors.

Dimension - [mm]

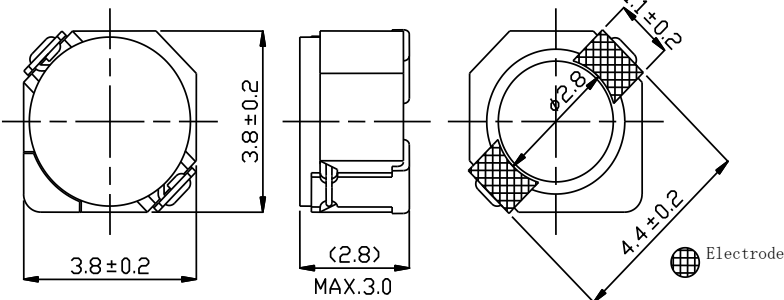

Land pattern and Schematics - [mm]

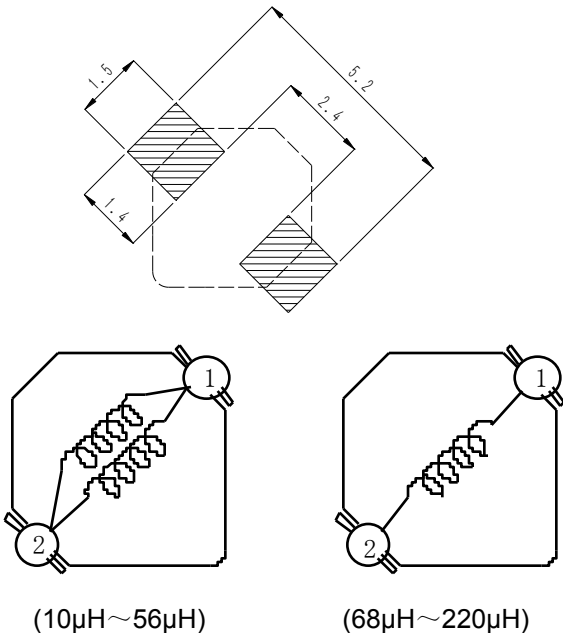

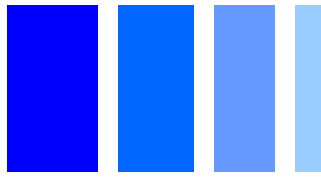

Electrical Characteristics

Part Name	Stamp	Inductance (μH) [within] ※1	D.C.R. (m Ω) Max. (Typ.) (at 20°C)	Saturation Current (A) ※2		Temperature Rise Current (A) ※3
				at 20°C	at 105°C	
CDRH3D28/LDNP-100NC	A	10 \pm 30%	95(73)	0.50	0.43	1.52
CDRH3D28/LDNP-120NC	B	12 \pm 30%	100(80)	0.45	0.38	1.48
CDRH3D28/LDNP-150NC	C	15 \pm 30%	115(90)	0.40	0.33	1.44
CDRH3D28/LDNP-180NC	D	18 \pm 30%	125(100)	0.35	0.30	1.37
CDRH3D28/LDNP-220NC	E	22 \pm 30%	145(117)	0.33	0.28	1.28
CDRH3D28/LDNP-270NC	F	27 \pm 30%	175(140)	0.29	0.26	1.18
CDRH3D28/LDNP-330NC	G	33 \pm 30%	215(170)	0.28	0.23	1.15
CDRH3D28/LDNP-390NC	H	39 \pm 30%	225(180)	0.25	0.21	1.00
CDRH3D28/LDNP-470NC	J	47 \pm 30%	305(245)	0.23	0.19	0.81
CDRH3D28/LDNP-560NC	K	56 \pm 30%	325(260)	0.20	0.17	0.76
CDRH3D28/LDNP-680NC	L	68 \pm 30%	470(375)	0.185	0.156	0.60
CDRH3D28/LDNP-820NC	M	82 \pm 30%	540(430)	0.172	0.142	0.58
CDRH3D28/LDNP-101NC	N	100 \pm 30%	610(485)	0.160	0.128	0.52
CDRH3D28/LDNP-121NC	P	120 \pm 30%	755(605)	0.136	0.116	0.50
CDRH3D28/LDNP-151NC	Q	150 \pm 30%	880(705)	0.124	0.106	0.48
CDRH3D28/LDNP-181NC	R	180 \pm 30%	1130(905)	0.119	0.095	0.42
CDRH3D28/LDNP-221NC	S	220 \pm 30%	1270(1015)	0.116	0.087	0.36

※1. Inductance measuring condition: at 100kHz.

※2. Saturation current: The value of D.C. current when the inductance decreases to 65% of it's nominal value.

※3. Temperature rise current: The value of D.C. current when the temperature rise is $\Delta t=40^\circ\text{C}$ ($T_a=20^\circ\text{C}$).

SMD Power Inductor CDRH3D28/LD



Saturation Current & Temperature Rise Graph

— L (20°C) — L (100°C) — ΔT

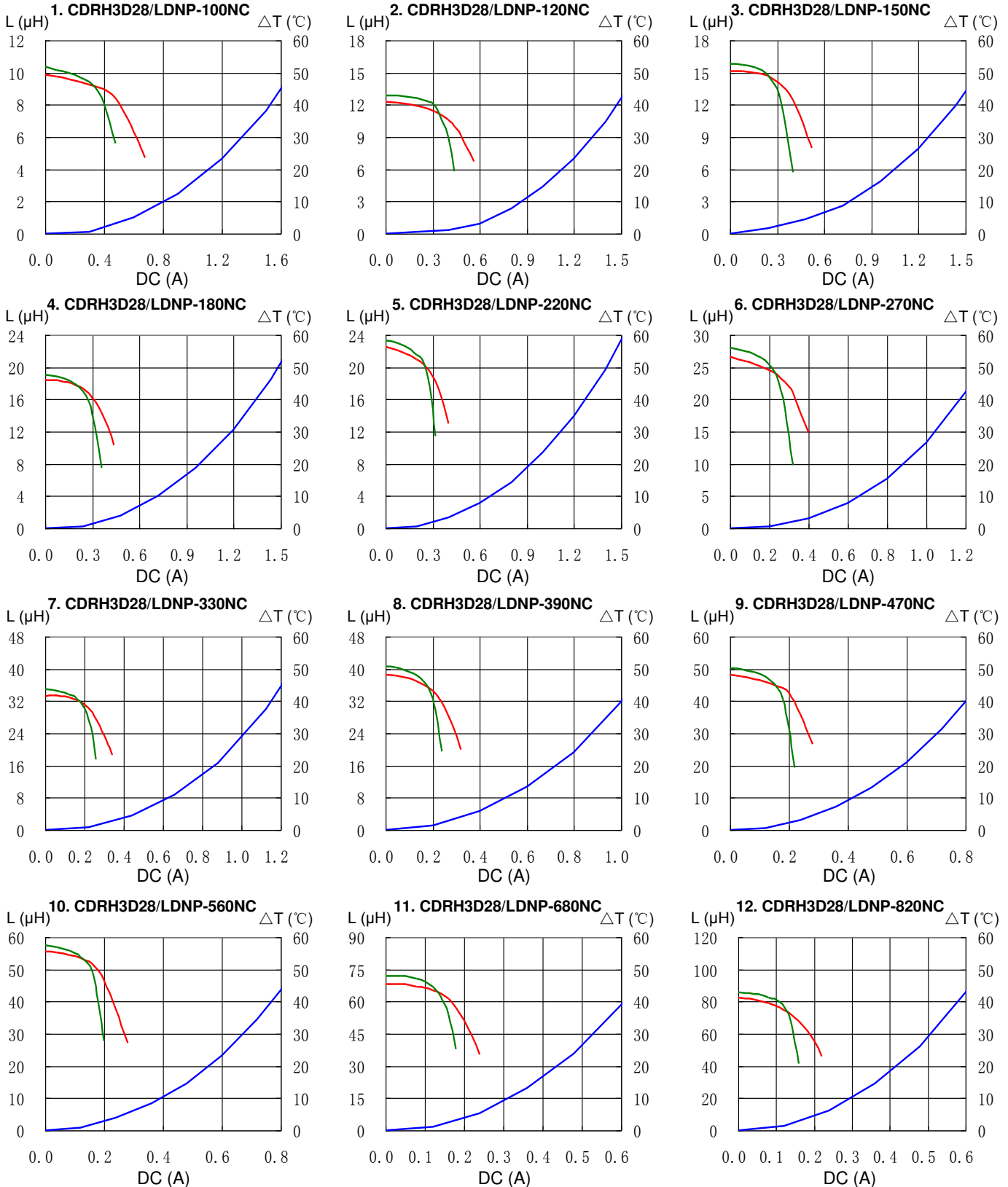

SMD Power Inductor CDRH3D28/LD

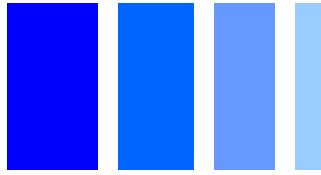

Saturation Current & Temperature Rise Graph

— L (20°C) — L (100°C) — ΔT

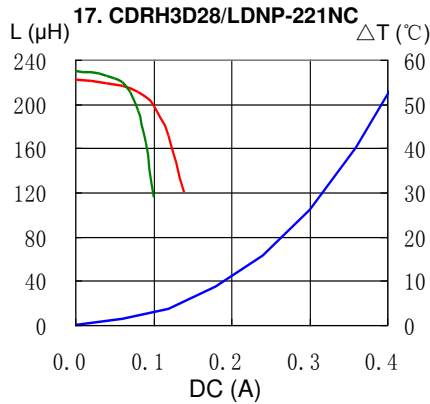
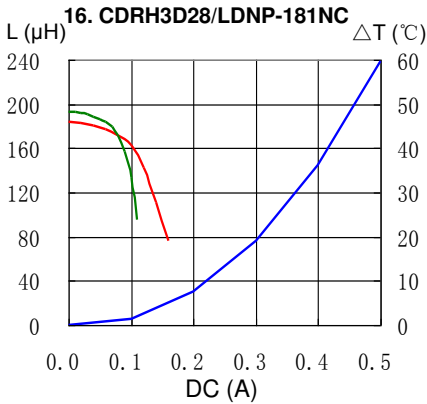
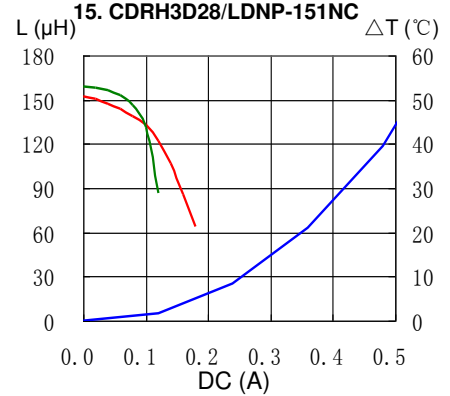
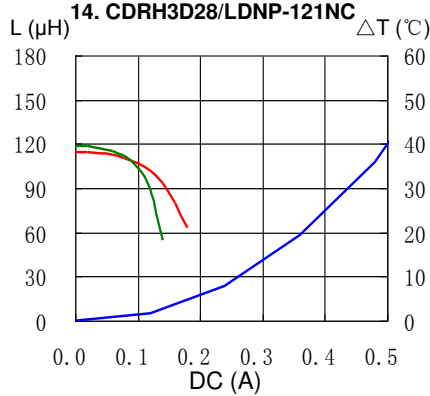
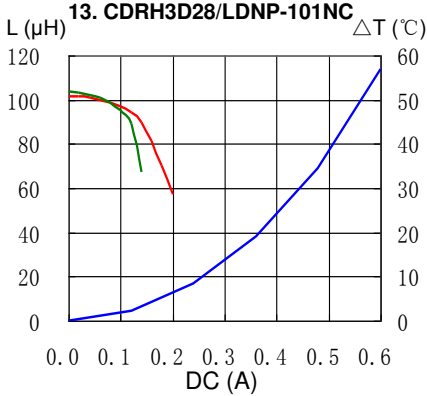

Solder Reflow Condition

Heat Endurance

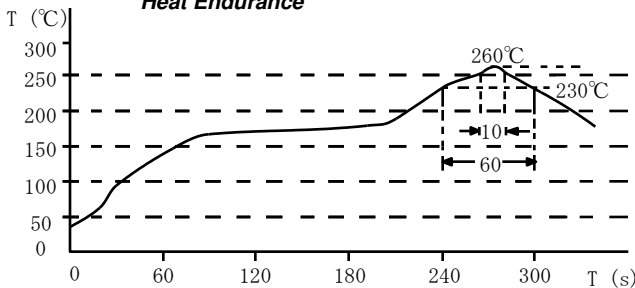

Temperature Chart

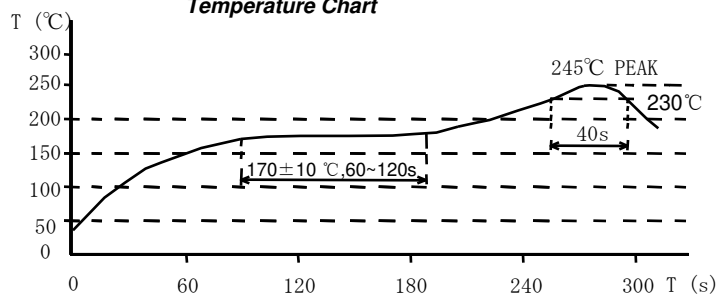

Please refer to the sales offices on our website - <http://www.sumida.com>

Hong Kong

Tel. +852-2880-6781
FAX. +852-2565-9600
sales@hk.sumida.com

Saitama(Japan)

Tel. +81-48-691-7300
FAX. +81-48-691-7340
sales@jp.sumida.com

Chicago

Tel. +1-847-545-6700
FAX. +1-847-545-6720
sales@us.sumida.com

Shanghai

Tel. +86-21-5836-3299
FAX. +86-21-5836-3266
shanghai.sales@cn.sumida.com

Seoul

Tel. +82-2-6237-0777
FAX. +82-2-6237-0778
sales@kr.sumida.com

Obernzell

Tel. +49-8591-937-0
FAX. +49-8591-937-103
contact@eu.sumida.com

Shenzhen

Tel. +86-755-8291-0228
FAX. +86-755-8291-0338
shenzhen.sales@cn.sumida.com

Singapore

Tel. +65-6296-3388
FAX. +65-6841-4426
sales@sg.sumida.com

Neumarkt

Tel. +49-9181-4509-110
FAX. +49-9181-4509-310
infocomp@eu.sumida.com

Taipei

Tel. +886-2-8751-2737
FAX. +886-2-8751-2738
sales@tw.sumida.com

San Jose

Tel. +1-408-321-9660
FAX. +1-408-321-9308
sales@us.sumida.com