



Chipsmall Limited consists of a professional team with an average of over 10 year of expertise in the distribution of electronic components. Based in Hongkong, we have already established firm and mutual-benefit business relationships with customers from,Europe,America and south Asia,supplying obsolete and hard-to-find components to meet their specific needs.

With the principle of “Quality Parts,Customers Priority,Honest Operation,and Considerate Service”,our business mainly focus on the distribution of electronic components. Line cards we deal with include Microchip,ALPS,ROHM,Xilinx,Pulse,ON,Everlight and Freescale. Main products comprise IC,Modules,Potentiometer,IC Socket,Relay,Connector.Our parts cover such applications as commercial,industrial, and automotives areas.

We are looking forward to setting up business relationship with you and hope to provide you with the best service and solution. Let us make a better world for our industry!



Contact us

Tel: +86-755-8981 8866 Fax: +86-755-8427 6832

Email & Skype: info@chipsmall.com Web: www.chipsmall.com

Address: A1208, Overseas Decoration Building, #122 Zhenhua RD., Futian, Shenzhen, China



SMD Power Inductor CDRH6D28

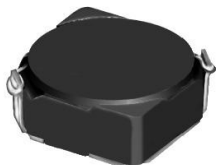

Description

- Ferrite drum core construction.
- Magnetically shielded.
- L × W × H: 7.0 × 7.0 × 3.0 mm Max.
- Product weight: 0.44g(Ref.)
- Moisture Sensitivity Level: 1
- RoHS compliance.

Environmental Data

- Operating temperature range: -40°C ~ +100°C (including coil's self temperature rise)
- Storage temperature range: -40°C ~ +100°C
- Solder reflow temperature: 260 °C peak.

Packaging

- Carrier tape and reel packaging
- 13" diameter reel
- 1500pcs per reel

Applications

- Ideally used in MP3, PDA, HDD, DSC/DVC, Notebook PC etc as DC-DC converter inductors.

Dimension - [mm]

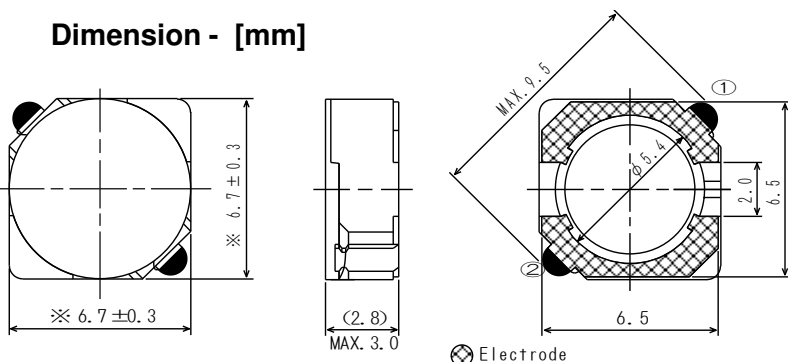

⊗ Electrode

Land pattern and Schematics - [mm]

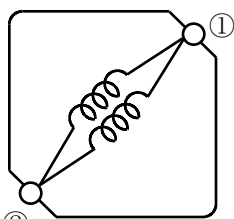
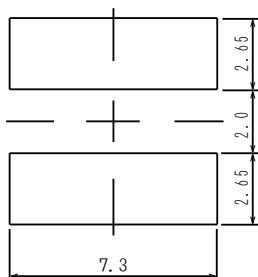

(3.0µH~6.0µH)

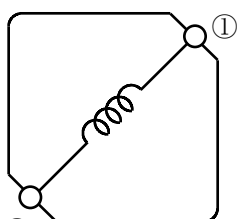

(7.3µH~100µH)

SMD Power Inductor

CDRH6D28

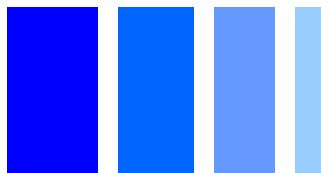

Electrical Characteristics

Part Name	Stamp	Inductance (μH) [within] ※1	D.C.R.(Ω) Max. (Typ.) (at 20°C)	Rated Current (A) ※2
CDRH6D28NP-3R0NC	3R0	3.0 \pm 30%	24m (18m)	3.00
CDRH6D28NP-3R9NC	3R9	3.9 \pm 30%	27m (20m)	2.60
CDRH6D28NP-5R0NC	5R0	5.0 \pm 30%	31m (23m)	2.40
CDRH6D28NP-6R0NC	6R0	6.0 \pm 30%	35m (26m)	2.25
CDRH6D28NP-7R3NC	7R3	7.3 \pm 30%	54m (40m)	2.10
CDRH6D28NP-8R6NC	8R6	8.6 \pm 30%	58m (43m)	1.85
CDRH6D28NP-100NC	100	10 \pm 30%	65m (48m)	1.70
CDRH6D28NP-120NC	120	12 \pm 30%	70m (52m)	1.55
CDRH6D28NP-150NC	150	15 \pm 30%	84m (62m)	1.40
CDRH6D28NP-180NC	180	18 \pm 30%	95m (70m)	1.32
CDRH6D28NP-220NC	220	22 \pm 30%	128m (95m)	1.20
CDRH6D28NP-270NC	270	27 \pm 30%	142m(105m)	1.05
CDRH6D28NP-330NC	330	33 \pm 30%	165m(122m)	0.97
CDRH6D28NP-390NC	390	39 \pm 30%	210m(156m)	0.86
CDRH6D28NP-470NC	470	47 \pm 30%	238m(176m)	0.80
CDRH6D28NP-560NC	560	56 \pm 30%	277m(205m)	0.73
CDRH6D28NP-680NC	680	68 \pm 30%	304m(225m)	0.65
CDRH6D28NP-820NC	820	82 \pm 30%	390m(290m)	0.60
CDRH6D28NP-101NC	101	100 \pm 30%	535m(397m)	0.54

※1. Inductance measuring condition: at 100kHz.

※2. Rated current: The DC current at which the inductance decreases to 65% of its nominal value or when $\Delta t=30^\circ\text{C}$, whichever is lower ($T_a=20^\circ\text{C}$).

SMD Power Inductor CDRH6D28

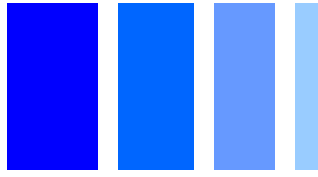

Saturation Current & Temperature Rise Graph

— L (20°C) — L (105°C) — ΔT

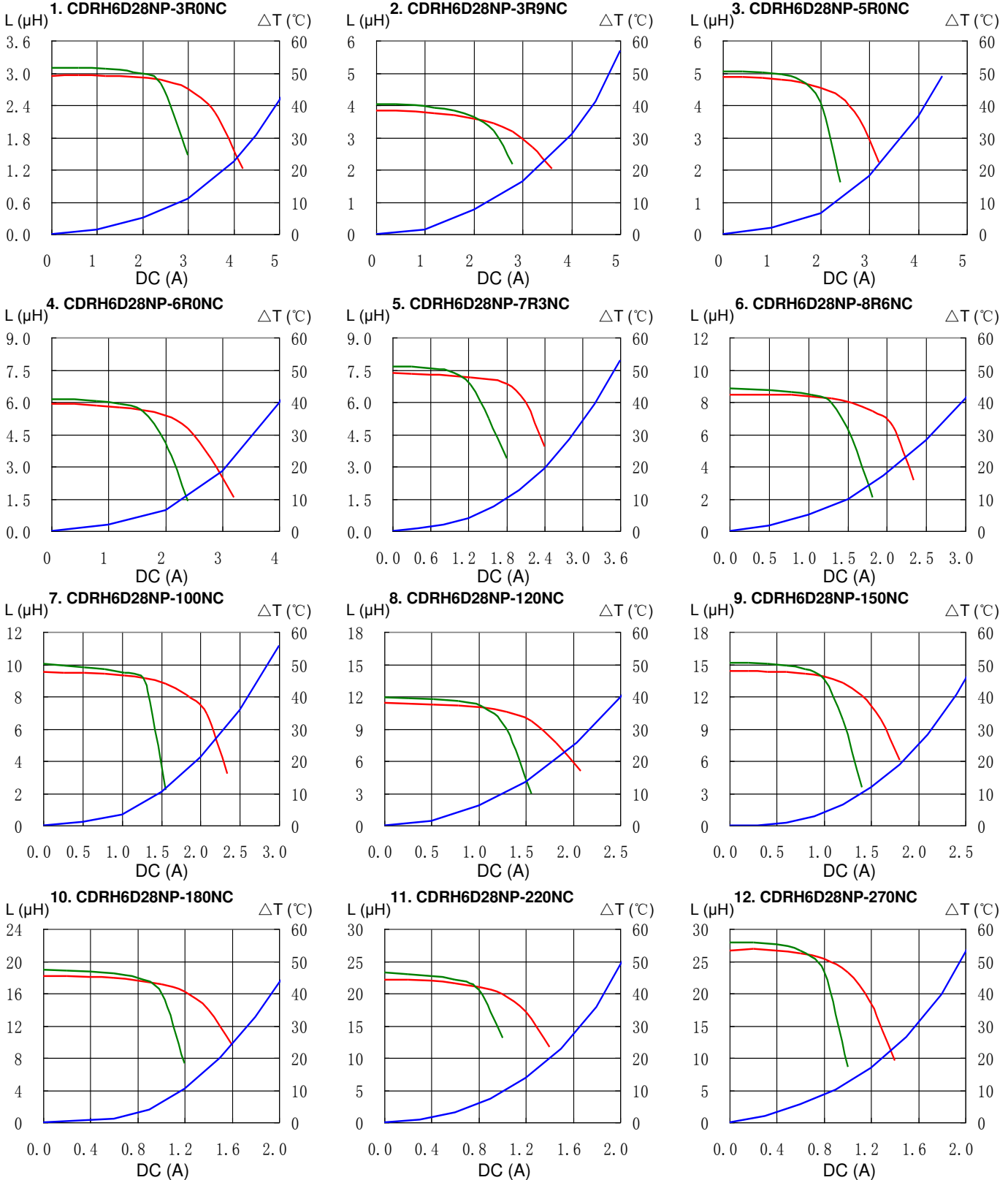

SMD Power Inductor CDRH6D28



Saturation Current & Temperature Rise Graph

— L (20°C) — L (105°C) — ΔT

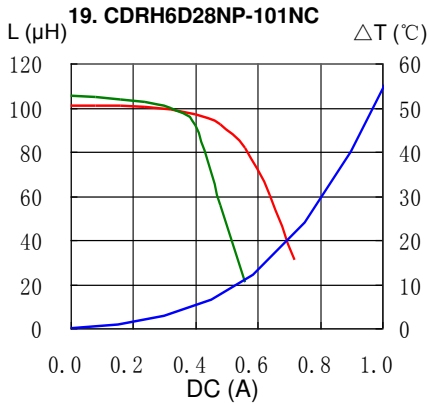
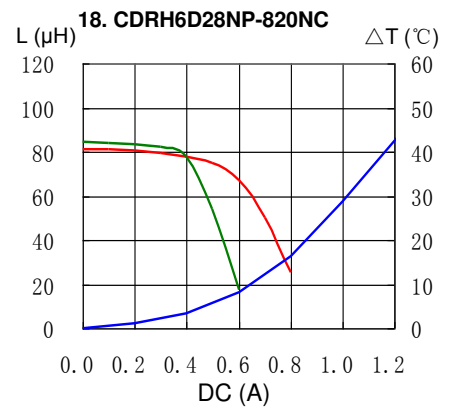
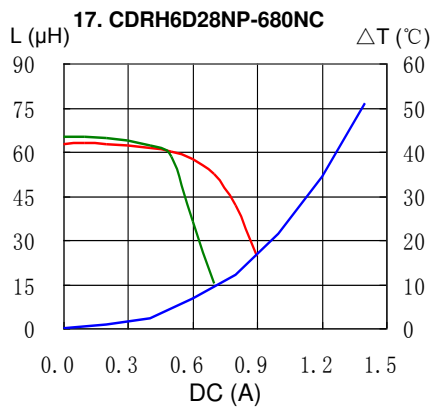
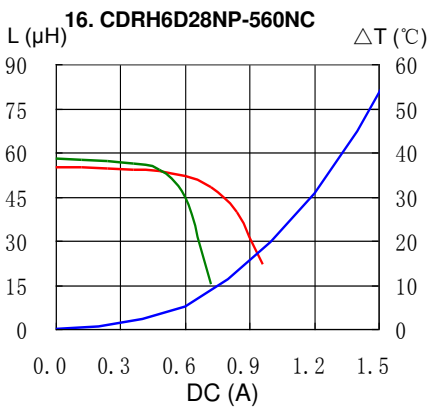
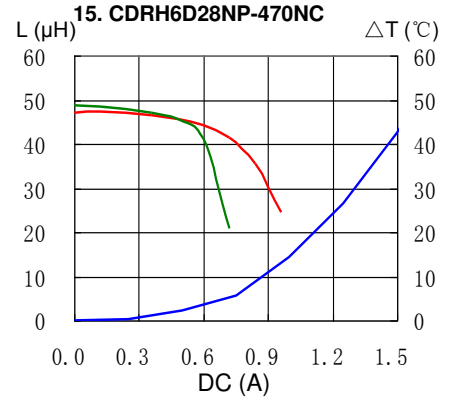
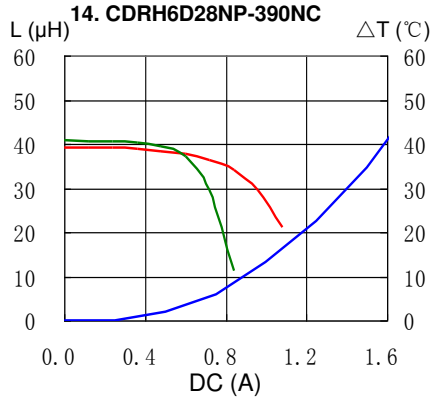
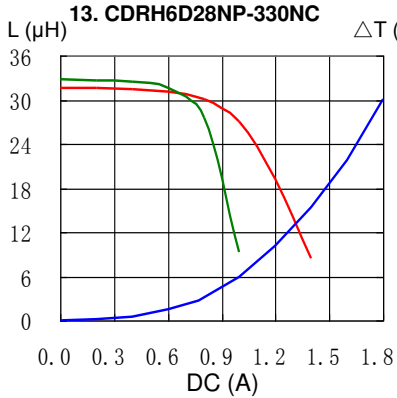

SMD Power Inductor CDRH6D28

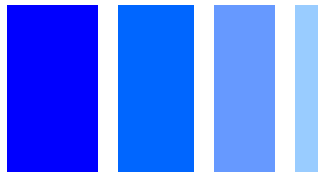

Solder Reflow Condition

Heat Endurance

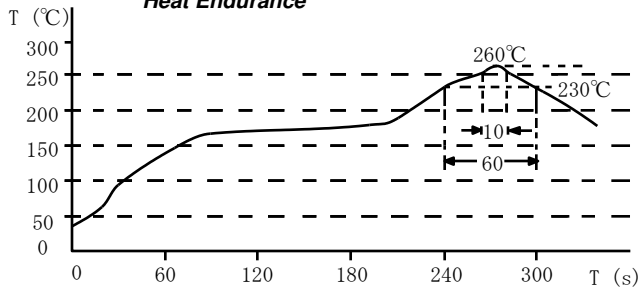

Temperature Chart

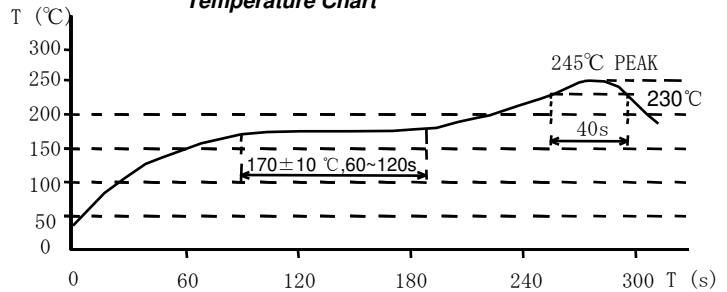

Please refer to the sales offices on our website - <http://www.sumida.com>

Hong Kong

Tel. +852-2880-6781
FAX. +852-2565-9600
sales@hk.sumida.com

Saitama(Japan)

Tel. +81-48-691-7300
FAX. +81-48-691-7340
sales@jp.sumida.com

Chicago

Tel. +1-847-545-6700
FAX. +1-847-545-6720
sales@us.sumida.com

Shanghai

Tel. +86-21-5836-3299
FAX. +86-21-5836-3266
shanghai.sales@cn.sumida.com

Seoul

Tel. +82-2-6237-0777
FAX. +82-2-6237-0778
sales@kr.sumida.com

Obernzell

Tel. +49-8591-937-0
FAX. +49-8591-937-103
contact@eu.sumida.com

Shenzhen

Tel. +86-755-8291-0228
FAX. +86-755-8291-0338
shenzhen.sales@cn.sumida.com

Singapore

Tel. +65-6296-3388
FAX. +65-6841-4426
sales@sg.sumida.com

Neumarkt

Tel. +49-9181-4509-110
FAX. +49-9181-4509-310
infocomp@eu.sumida.com

Taipei

Tel. +886-2-8751-2737
FAX. +886-2-8751-2738
sales@tw.sumida.com

San Jose

Tel. +1-408-321-9660
FAX. +1-408-321-9308
sales@us.sumida.com