



Chipsmall Limited consists of a professional team with an average of over 10 year of expertise in the distribution of electronic components. Based in Hongkong, we have already established firm and mutual-benefit business relationships with customers from,Europe,America and south Asia,supplying obsolete and hard-to-find components to meet their specific needs.

With the principle of “Quality Parts,Customers Priority,Honest Operation,and Considerate Service”,our business mainly focus on the distribution of electronic components. Line cards we deal with include Microchip,ALPS,ROHM,Xilinx,Pulse,ON,Everlight and Freescale. Main products comprise IC,Modules,Potentiometer,IC Socket,Relay,Connector.Our parts cover such applications as commercial,industrial, and automotives areas.

We are looking forward to setting up business relationship with you and hope to provide you with the best service and solution. Let us make a better world for our industry!



## Contact us

Tel: +86-755-8981 8866 Fax: +86-755-8427 6832

Email & Skype: info@chipsmall.com Web: www.chipsmall.com

Address: A1208, Overseas Decoration Building, #122 Zhenhua RD., Futian, Shenzhen, China





## Features

- Low power loss and high efficiency
- Low forward voltage
- High surge capability
- High reverse robustness
- RoHS compliant\*

## Applications

- Switch Mode Power Supplies (SMPS)
- Bridge Full Wave Rectification
- Lighting Ballasts
- Battery Chargers

# CDT0269-BR1xL Surface Mount Bridge Rectifier Diode

## General Information

The markets for portable communications, computing and video equipment are challenging the semiconductor industry to develop increasingly smaller electronic components. Bourns offers the Model CDT0269-BR1xL surface mount bridge rectifier diodes with overvoltage protection for rectification applications in a TO-269AA package, providing PCB real estate savings due to their considerable size difference compared to most competitive parts. The Model CDT0269-BR1xL surface mount bridge rectifier diodes with overvoltage protection offer a forward current of 1 A with a choice of repetitive peak reverse voltages of 190 V and 380 V.

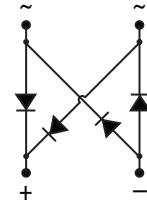

## Absolute Maximum Ratings (@ T<sub>A</sub> = 25 °C Unless Otherwise Noted)

Parameter	Symbol	CDT0269-		Unit
		BR1190L	BR1380L	
Maximum Repetitive Peak Reverse Voltage	V <sub>RRM</sub>	190	380	V
Alternating Input Voltage	V <sub>RMS</sub>	140	280	V
Reverse Avalanche Energy	E <sub>RSM</sub>	20		mJ
Maximum Output Rectified Current (T <sub>A</sub> = 50 °C)	I <sub>FAV</sub>	1		A
Repetitive Peak Forward Current (F > 15 Hz) (NOTE 1)	I <sub>FRM</sub>	15		A
Peak Forward Surge Current (50 Hz Half Sine-Wave)	I <sub>FSM</sub>	50		A
Peak Forward Surge Current (60 Hz Half Sine-Wave)	I <sub>FSM</sub>	55		A
Non-Repetitive Peak Forward Surge Current (10/1000 μS)	I <sub>FPM</sub>	75		A
ESD Rating (JESD22-A114)	V <sub>ESD</sub>	8		kV
Operating Temperature Range	T <sub>J</sub>	-50 to +150		°C
Storage Temperature Range	T <sub>STG</sub>	-50 to +150		°C

## Electrical Characteristics (@ T<sub>A</sub> = 25 °C Unless Otherwise Noted)

Parameter	Symbol	CDT0269-BR1xL			Unit	
		Test Conditions	Min.	Typ.		Max.
Instantaneous Forward Voltage	V <sub>F</sub>	I <sub>F</sub> = 1 A			0.95	V
Reverse Leakage Current	I <sub>R</sub>	V <sub>WM</sub> = V <sub>RRM</sub>			5	μA
Reverse Breakdown Voltage	V <sub>BR</sub>	CDT0269-BR1190L	210			V
		CDT0269-BR1380L	400			
Reverse Recovery Time	t <sub>rr</sub>	I <sub>F</sub> = 0.5 A and I <sub>R</sub> = 1 A to 0.25 A		1500		nS
Thermal Resistance, Junction to Ambient (NOTE 1)	R <sub>thA</sub>				60	K / W

NOTE 1: Measured when mounted on PCB with 25 mm<sup>2</sup> copper pad areas.

\*RoHS Directive 2002/95/EC Jan. 27, 2003 including annex and RoHS Recast 2011/65/EU June 8, 2011. Specifications are subject to change without notice. Users should verify actual device performance in their specific applications. The products described herein and this document are subject to specific disclaimers as set forth on the last page of this document.

Rating and Characteristic Curves

Derating Curve for Output Rectified Current

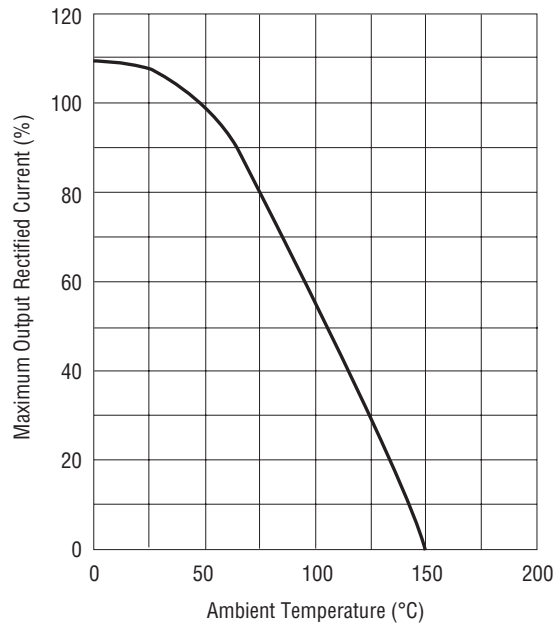

Typical Junction Capacitance

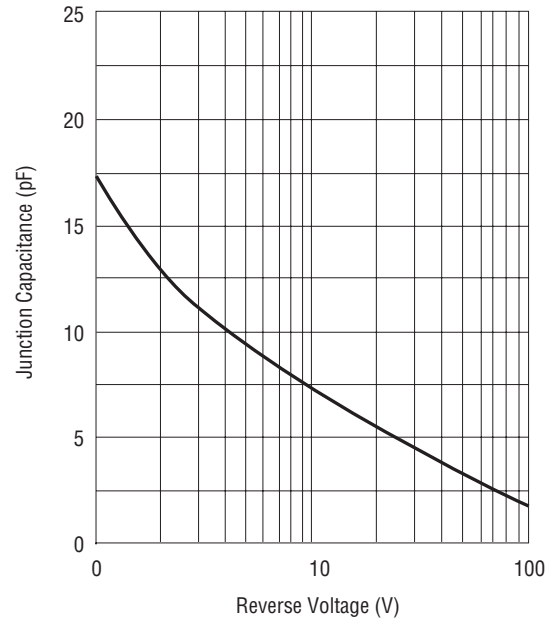

Typical Forward Voltage Characteristics

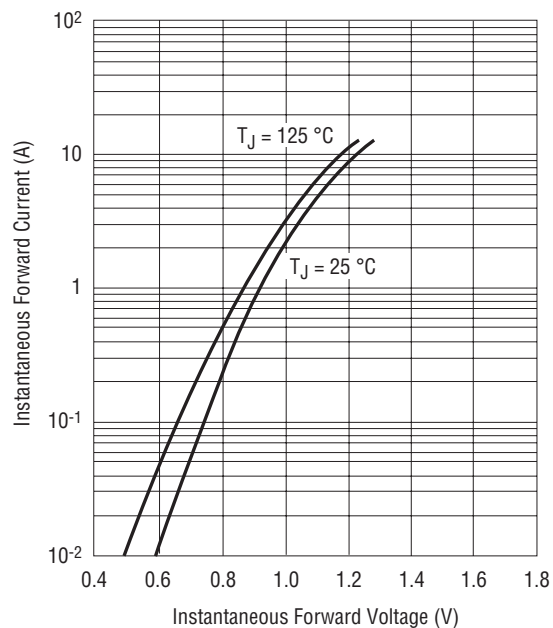

Typical Reverse Leakage Characteristics

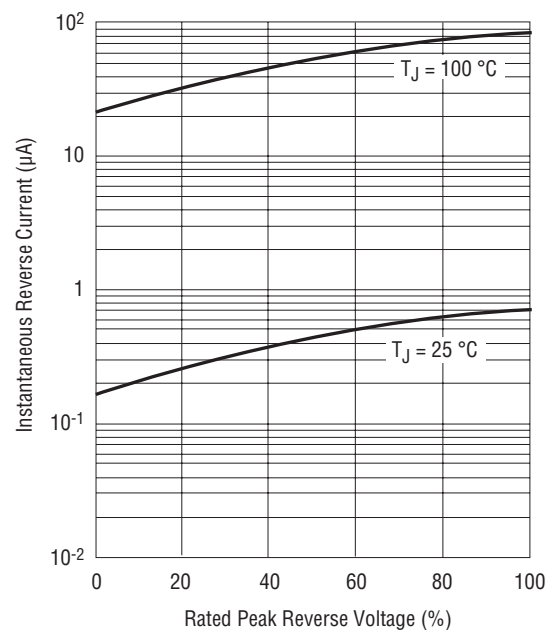

Specifications are subject to change without notice.  
 Users should verify actual device performance in their specific applications.  
 The products described herein and this document are subject to specific disclaimers as set forth on the last page of this document.

# CDT0269-BR1xL Surface Mount Bridge Rectifier Diode



## Product Dimensions

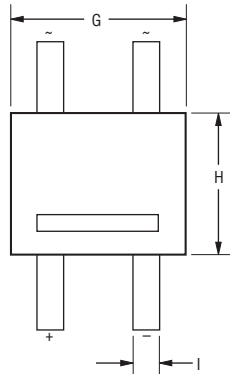
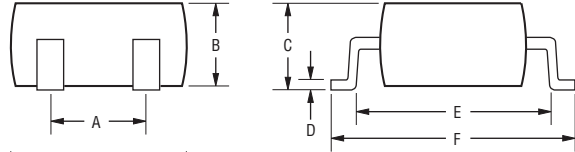

DIMENSIONS:  $\frac{\text{MM}}{\text{(INCHES)}}$

Dim.	TO-269AA Package
A	$\frac{2.54}{(0.100)}$
B	$\frac{1.5 \pm 0.1}{(0.059 \pm 0.004)}$
C	$\frac{1.6 \pm 0.1}{(0.063 \pm 0.004)}$
D	$\frac{0.2}{(0.008)}$
E	$\frac{5.1 \pm 0.2}{(0.201 \pm 0.008)}$
F	$\frac{6.5 \pm 0.2}{(0.256 \pm 0.008)}$
G	$\frac{4.7 \pm 0.1}{(0.185 \pm 0.004)}$
H	$\frac{3.9 \pm 0.1}{(0.154 \pm 0.004)}$
I	$\frac{0.7}{(0.028)}$

## How to Order

Common Code **CD TO269 - BR 1 190 L**  
 CD = Chip Diode  
 Package TO269 = TO-269AA  
 Diode Series BR = Bridge Rectifier  
 Maximum Average Forward Rectified Current 1 = 1 A  
 Maximum Repetitive Peak Reverse Voltage 190 = 190 V  
 380 = 380 V  
 Suffix L = Low Forward Voltage

## Typical Part Marking

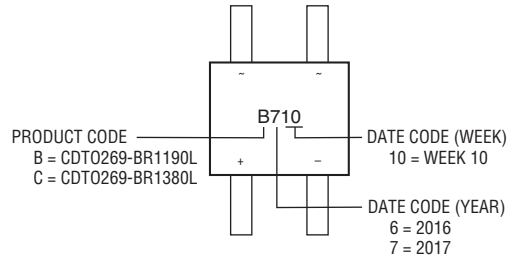

## Recommended Footprint

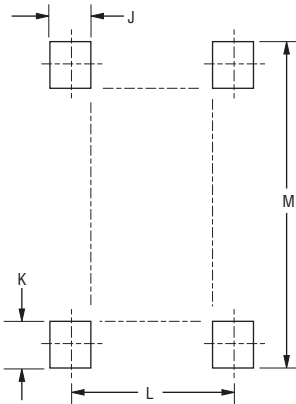

Dim.	TO-269AA Package
J	$\frac{1.0 \pm 0.2}{(0.039 \pm 0.008)}$
K	$\frac{1.1 \pm 0.2}{(0.043 \pm 0.008)}$
L	$\frac{2.54 \pm 0.1}{(0.100 \pm 0.004)}$
M	$\frac{6.9}{(0.272)}$ MAX.

DIMENSIONS:  $\frac{\text{MM}}{\text{(INCHES)}}$

## Environmental Specifications

Moisture Sensitivity Level.....1  
 ESD Classification (HBM).....3B



# CDT0269-BR1xL Surface Mount Bridge Rectifier Diode

**BOURNS®**

## Packaging Information

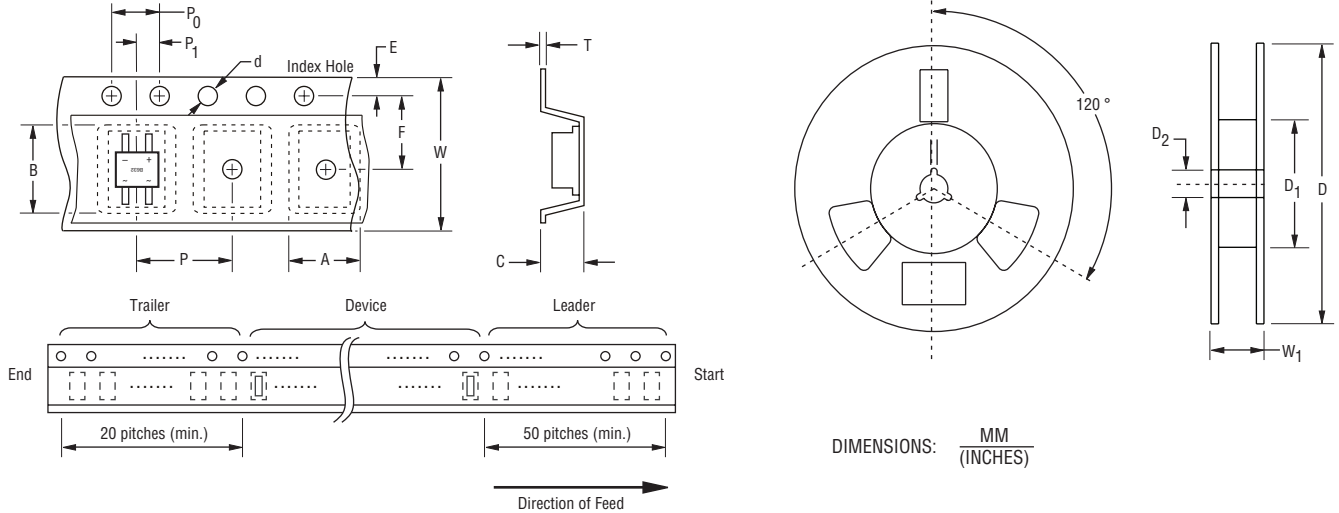

DIMENSIONS:  $\frac{\text{MM}}{\text{(INCHES)}}$

Item	Symbol	TO269-AA
Carrier Width	A	$\frac{5.0}{(0.197)}$
Carrier Length	B	$\frac{7.3}{(0.287)}$
Carrier Depth	C	$\frac{1.8}{(0.071)}$
Sprocket Hole	d	$\frac{1.5 \pm 0.1}{(0.059 \pm 0.004)}$
Reel Outside Diameter	D	$\frac{330}{(12.992)}$
Reel Inner Diameter	D <sub>1</sub>	$\frac{60.0}{(2.362)}$ MIN.
Feed Hole Diameter	D <sub>2</sub>	$\frac{0.51 \pm 0.020}{(0.059 \pm 0.008)}$
Sprocket Hole Position	E	$\frac{1.75}{(0.069)}$
Punch Hole Position	F	$\frac{5.5 \pm 0.1}{(0.217 \pm 0.004)}$
Punch Hole Pitch	P	$\frac{8.0 \pm 0.1}{(0.315 \pm 0.004)}$
Sprocket Hole Pitch	P <sub>0</sub>	$\frac{4.0 \pm 0.1}{(0.157 \pm 0.004)}$
Embossment Center	P <sub>1</sub>	$\frac{2.0 \pm 0.05}{(0.079 \pm 0.002)}$
Overall Tape Thickness	T	$\frac{2.0 \pm 0.1}{(0.079 \pm 0.004)}$
Tape Width	W	$\frac{12.0}{(0.472)}$
Reel Width	W <sub>1</sub>	$\frac{17.6}{(0.693)}$ MAX.
Quantity per Reel	--	5,000

**BOURNS®**

### Asia-Pacific:

Tel: +886-2 2562-4117

Email: asiacus@bourns.com

### Europe:

Tel: +36 88 520 390

Email: eurocus@bourns.com

### The Americas:

Tel: +1-951 781-5500

Email: americus@bourns.com

[www.bourns.com](http://www.bourns.com)

08/17

Specifications are subject to change without notice.  
Users should verify actual device performance in their specific applications.  
The products described herein and this document are subject to specific disclaimers as set forth on the last page of this document.